

STAFF ORGANIZATION AND OPERATIONS

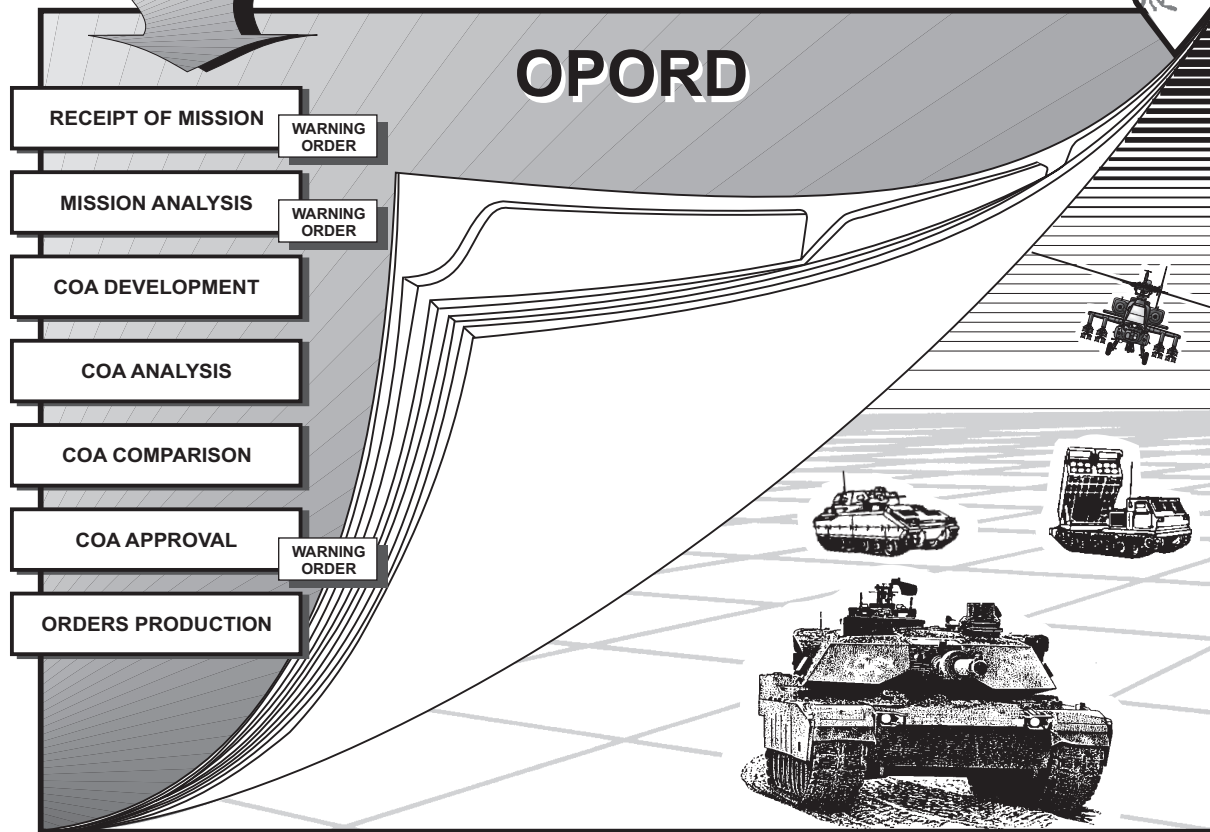
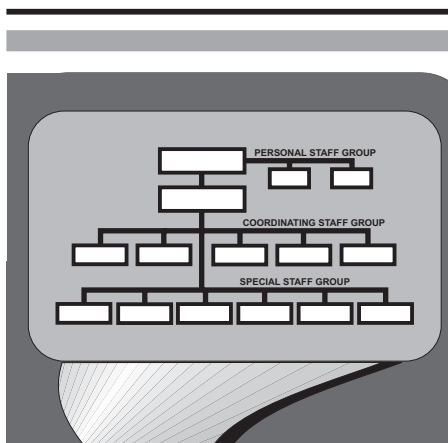

Headquarters, Department of the Army

DISTRIBUTION RESTRICTION: Approved for public release; distribution is unlimited

STAFF ORGANIZATION AND OPERATIONS

CONTENTS

	Page
Preface	vii
Chapter 1 COMMAND AND STAFF RELATIONSHIPS	1-1
Command and Control	1-1
Command.	1-1
Control	1-2
Command and Control (C ²) System	1-2
The Staff's Role	1-3
Battlefield Visualization.	1-3
Chapter 2 STAFF ORGANIZATION	2-1
Basis for Staff Organizations	2-1
Factors Affecting Staff Organizations	2-1
Authorization for Staff Organizations	2-2
Basic Staff Structure Model	2-2
Chief of Staff (Executive Officer)	2-2
Coordinating Staff Group.	2-2
Special Staff Group.	2-3
Personal Staff Group	2-3
Staff Models	2-3
Major Commands (G Staffs) (Corps and Division)	2-4
Staffs of Smaller Units (S Staffs) (Regiments, Brigades, and Battalions).	2-4
Chapter 3 CHARACTERISTICS OF A STAFF OFFICER	3-1
Characteristics.	3-1
Competence	3-1
Initiative and Judgment	3-1
Creativity	3-2
Flexibility.	3-2
Confidence	3-2
Loyalty	3-2
Team Player	3-2
Effective Manager	3-3
Effective Communicator	3-3
Chapter 4 STAFF RESPONSIBILITIES AND DUTIES	4-1
The Commander-Staff Relationship.	4-1
Deputy or Assistant Commander-Staff Relationship	4-1
Chief of Staff (Executive Officer)-Staff Relationship	4-2
Staff Activities.	4-3
Common Responsibilities and Duties	4-3
Advising and Providing Information to the Commander	4-3

DISTRIBUTION RESTRICTION: Approved for public release; distribution is unlimited.
*This publication supersedes FM 101-5, 25 May 1984.

Preparing, Updating, and Maintaining Estimates	4-4
Making Recommendations	4-4
Preparing Plans and Orders	4-5
Monitoring Execution of Decisions	4-5
Processing, Analyzing, and Disseminating Information	4-5
Identifying and Analyzing Problems	4-6
Conducting Staff Coordination	4-6
Conducting Training	4-7
Performing Staff Assistance Visits	4-7
Performing Risk Management	4-7
Conducting Staff Inspections	4-7
Conducting Staff Writing	4-8
Conducting Staff Research	4-8
Performing Staff Administrative Procedures	4-8
Supervising Staff Section and Staff Personnel	4-8
Specific Staff Responsibilities and Duties	4-8
Coordinating Staff Officers	4-8
Assistant Chief of Staff, G1 (S1), Personnel	4-9
Assistant Chief of Staff, G2 (S2), Intelligence	4-10
Assistant Chief of Staff, G3 (S3), Operations	4-12
Assistant Chief of Staff, G4 (S4), Logistics	4-14
Assistant Chief of Staff, G5 (S5), Civil-Military Operations	4-15
Assistant Chief of Staff, G6 (S6), Signal	4-16
Support Operations Officer/Materiel Officer	4-17
Special Staff Officer	4-17
Chief of Staff (CofS)	4-17
Headquarters Commandant	4-18
Secretary of the General Staff (SGS)	4-18
Resource Manager/Comptroller	4-18
G1 (S1)	4-19
Adjutant General (AG)	4-19
Civilian Personnel Officer (CPO)	4-19
Dental Surgeon	4-20
Equal Opportunity Advisor (EOA)	4-20
Finance Officer	4-20
Surgeon	4-21
Veterinary Officer	4-21
G2 (S2)	4-22
Staff Weather Officer	4-22
G3 (S3)	4-22
Air Defense Coordinator (ADCOORD)	4-22
Air Liaison Officer (ALO)	4-22
Air/Naval Gunfire Liaison Company (ANGLICO) Commander	4-23
Aviation Coordinator (AVCOORD)	4-23
Chemical Officer (CHEMO)	4-23
Deception Officer	4-24
Electronic Warfare Officer (EWO)	4-25
Engineer Coordinator (ENCOORD)	4-25
Explosive Ordnance Disposal (EOD) Officer	4-25
Fire Support Coordinator (FSCOORD)	4-26
Historian	4-26
Liaison Officer (LNO)	4-27

Provost Marshal (PM)	4-27
Psychological Operations (PSYOP) Officer	4-27
Safety Officer	4-28
Special Operations Coordinator (SOCOORD)	4-28
Theater Airlift Liaison Officer (TALO)	4-29
G4 (S4)	4-29
Transportation Officer	4-29
Personal Staff	4-29
Command Sergeant Major (CSM) (No Coordinating Staff Responsibility)	4-30
Aide-De-Camp (No Coordinating Staff Responsibility)	4-30
Chaplain (Coordinating Staff Responsibility, ACofS, G1/S1, when required)	4-30
Inspector General (IG) (Coordinating Staff Responsibility, ACofS, G1/S1, when required)	4-31
Public Affairs Officer (PAO) (Coordinating Staff Responsibility, ACofS, G1/S1, when required)	4-31
Staff Judge Advocate (SJA) (Coordinating Staff Responsibility, ACofS, G1/S1, when required)	4-32
Chapter 5 THE MILITARY DECISION-MAKING PROCESS	5-1
Roles of the Commander and Staff	5-1
The Role of Reconnaissance During the Planning Process	5-2
The Military Decision-Making Process Model	5-3
Receipt of Mission	5-3
Mission Analysis	5-5
Course of Action Development	5-11
Qualities of COAs	5-11
Guidelines and Steps to Develop COAs	5-11
COA Briefing (Optional)	5-16
Course of Action Analysis (War Game)	5-16
The War-Gaming Process	5-16
The General Rules of War Gaming	5-16
War-Gaming Responsibilities	5-17
War-Gaming Steps	5-17
War-Game Briefing (Optional)	5-24
Course of Action Comparison	5-24
Commander's Decision Briefing	5-24
Course of Action Approval	5-26
Orders Production	5-26
Decision Making in a Time-Constrained Environment	5-27
General Considerations	5-27
The Commander's Role	5-28
The Staff's Role	5-29
Mission Receipt	5-29
Mission Analysis	5-29
Commander's Guidance	5-29
Course of Action Development	5-30
Course of Action Analysis	5-30
Course of Action Comparison	5-31
Course of Action Approval	5-31
Orders Production	5-31

Chapter 6 STAFF OFFICER DUTIES DURING PREPARATION FOR AND EXECUTION OF OPERATIONS.	6-1
Chief of Staff (XO) Duties.	6-1
Staff Officer Duties	6-2
Identifying and Anticipating Requirements	6-3
Monitoring Operations	6-3
Directing Actions.	6-4
Managing Information	6-4
Making Recommendations	6-5
Conducting Coordination.	6-5
Synchronizing Operations	6-5
Maintaining Continuity.	6-5
Appendix A MISSION ANALYSIS GUIDELINES.	A-1
Appendix B COMMANDER’S GUIDANCE GUIDELINES.	B-1
Appendix C STAFF ESTIMATES.	C-1
Essential Qualities of Estimates.	C-1
Types of Estimates	C-1
Commander’s Estimate	C-2
Operations Estimate	C-2
Personnel Estimate.	C-2
Intelligence Estimate.	C-2
Logistics Estimate	C-2
Civil-Military Operations Estimate	C-2
Signal Estimate	C-2
Special Staff Estimates.	C-3
Staff Estimate Format	C-3
Appendix D STAFF STUDIES AND DECISION PAPERS	D-1
Staff Studies	D-1
Preparing the Staff Study.	D-1
Coordinating the Staff Study.	D-2
Common Problems of Staff Studies	D-2
Decision Papers.	D-6
Appendix E MILITARY BRIEFINGS.	E-1
Types of Briefings.	E-1
Information.	E-1
Decision	E-1
Mission.	E-1
Staff	E-1
Briefing Steps	E-2
Briefing Outline.	E-3
Format for an Information Briefing.	E-5
Format for a Decision Briefing.	E-6
The Mission Briefing.	E-6
The Staff Briefing	E-7
Appendix F TASK ORGANIZATION	F-1
Fundamental Considerations	F-1
Command and Support Relationships	F-2
Formatting Task Organization	F-3

The Outline Method	F-3
The Matrix Method	F-5
Appendix G REHEARSALS	G-1
Rehearsal Types	G-1
Confirmation Brief	G-1
Backbrief	G-1
Combined Arms Rehearsal	G-1
Support Rehearsal	G-1
Battle Drill or SOP Rehearsals	G-2
Rehearsal Techniques	G-2
Full Dress Rehearsal	G-2
Reduced Force Rehearsal	G-2
Terrain Model Rehearsal	G-3
Sketch Map Rehearsal	G-4
Map Rehearsal	G-4
Radio Rehearsal	G-4
Rehearsal Responsibilities	G-5
Planning	G-5
Preparation	G-5
Execution	G-6
Rehearsal Script	G-6
The Agenda	G-7
Response Sequence	G-7
Actions Checklist	G-7
Sequence of Events	G-7
Other Considerations	G-8
Conducting a Rehearsal	G-9
Before the Rehearsal	G-9
During the Rehearsal	G-9
After the Rehearsal	G-11
Appendix H PLANS AND ORDERS	H-1
Plans	H-2
Orders	H-2
Characteristics of OPLANs and OPORDs	H-3
Techniques for Issuing Orders	H-4
Administrative Instructions for Preparing Plans and Orders	H-5
General Information	H-5
Abbreviations	H-5
Place and Direction Designations	H-5
Naming Conventions	H-6
Classification Markings and Procedures	H-6
Annotating Unnamed Dates and Times	H-6
Annotating Time	H-7
Identification of Succeeding Pages of the Plan or Order	H-7
Page Numbering	H-7
Annexes, Appendixes, Tabs, Enclosures	H-7
Standing Operating Procedures	H-8
Matrixes and Templates	H-8
Examples and Procedures for Completing Plans, Orders, and Annexes	H-11
Operation Order Vignette	H-73
Appendix I INFORMATION MANAGEMENT	I-1

Information Available to the Commander	I-1
The Military Information System	I-1
Categories of Information	I-1
Critical Information	I-1
Exceptional Information	I-2
Routine Information	I-2
Channels	I-2
Information Presentation	I-3
Information Impediments and Solution	I-3
Information Management Resources	I-4
Reports by Exception	I-4
Charts and Maps	I-4
Impact on Decision Making	I-5
Appendix J RISK MANAGEMENT	J-1
Definitions	J-1
Risk Management Steps	J-2
Appendix K COMMANDER AND STAFF TRAINING	K-1
Fundamentals	K-1
Techniques	K-3
Appendix L LIAISON	L-1
Liaison Elements	L-1
The Liaison Officer	L-1
Liaison Principles	L-2
Liaison Responsibilities	L-2
The Sending Unit	L-2
The Receiving Unit	L-3
Liaison Duties During the Tour	L-3
Liaison Duties After the Tour	L-4
Liaison in Specific Operations	L-4
Deployment Operations	L-4
Joint Operations	L-4
Multinational Operations	L-5
Interagency Operations	L-5
Liaison Checklist	L-6
Example Outline of a Liaison Officer's Handbook	L-7
Glossary	Glossary-1
References	References-1
Index	Index-1

PREFACE

This publication is the Army's capstone manual for staff organization and operations of major tactical and major tactical support commands at corps level and below. Field Manual (FM) 101-5 describes basic doctrine of the roles, relationships, organization, and responsibilities of staffs in the United States (US) Army. It does not cover staffs of units at echelons above corps and joint level. FM 101-5 is intended for use by staff officers in carrying out their duties and responsibilities as they assist the commander in accomplishing the mission. A commander may establish procedures and may organize the staff as necessary to conform with the mission, resources available, and level of command. However, the staff should continue to function along the direction described to maintain a common understanding among units.

FM 101-5 is the Army's doctrinal source for the military decision-making process, the doctrinal approach to decision making that helps the commander and his staff examine a situation and reach logical decisions.

FM 101-5 does not detail tactical missions or the use of forces during operations. The examples provided are guides only, showing general application procedures. This manual is the authoritative foundation for doctrine; procedures and techniques; force design; materiel acquisition; professional education; individual, unit, and service school training; and research and development for staffs and their functions.

Every attempt has been made to ensure that this manual is consistent with current joint doctrine and publications.

Headquarters, TRADOC, is the proponent for this publication. Send comments and recommended changes on DA Form 2028 to Commander, US Army Combined Arms Center and Fort Leavenworth, ATTN: ATZL-SWW-D, Fort Leavenworth, KS 66027-6900.

Unless otherwise stated, whenever the masculine or feminine gender is used, both men and women are included.

Chapter 1

COMMAND AND STAFF RELATIONSHIPS

Staffs exist to help the commander make and implement decisions. No command decision is more important, or more difficult to make, than that which risks the lives of soldiers to impose the nation's will over a resisting enemy. Staff organizations and procedures are structured to meet the commander's critical information requirements. Therefore, to understand the staff and its organization, responsibilities, and procedures, it is first necessary to understand how commanders command. Since the Army exists to successfully fight and win the nation's wars, understanding command begins with understanding how the Army fights. The skills, procedures, and techniques associated with command in war also may apply to managing Army organizations in peacetime, however our doctrine must focus on warfighting.

COMMAND AND CONTROL

Command and control is an essential element of the art and science of warfare. Command and control is the exercise of authority and direction by a properly designated commander over assigned and attached forces in the accomplishment of the mission. Command and control functions are performed through an arrangement of personnel, equipment, communications, facilities, and procedures employed by a commander in planning, directing, coordinating, and controlling forces and operations in the accomplishment of the mission.

The focus of command and control is the *commander*. Command is the authoritative act of making decisions and ordering action; control is the act of monitoring and influencing this action. While command and control may be discussed separately for understanding, in practice, command and control is a unified entity. The commander cannot command effectively without control, and he, with or without the staff, cannot exercise control without command.

The commander uses command and control, which includes the staff, to make effective decisions, to manage the uncertainty of combat, to employ military forces efficiently, and to direct the successful execution of military operations. In short, the goal of command and control is mission accomplishment, while the object of command and control is forces. The staff is the most important resource that the commander uses to exercise

command and control when the commander cannot exercise command and control by himself.

Command

Command is the authority a commander in military service lawfully exercises over subordinates by virtue of rank and assignment. Command includes the authority and responsibility for effectively using available resources and for planning the employment of, organizing, directing, coordinating, and controlling military forces for the accomplishment of assigned missions.

However, command is more than the constitutional, legal authority vested in an individual. It goes beyond the practiced application of managerial skills to efficiently use available resources to accomplish assigned missions.

Command is the art of decision making and of leading and motivating soldiers and their organizations into action to impose the nation's will over the enemy and accomplish missions at the least expense in manpower and material. Command is vested in an individual who has total responsibility. The essence of command is defined by the commander's competence, intuition, judgment, initiative, and character, and his ability to inspire and gain the trust of his unit. Commanders possess authority and responsibility and are accountable while in command.

Authority involves the right and freedom to use the power of command and, ultimately, to enforce obedience. The commander's authority to enforce his decisions is one of the key elements of his position. However, with the right to enforce decisions comes the responsibility for their consequences. To command is to direct with authority.

Responsibility is the legal and ethical obligation a commander assumes for the actions, accomplishments, or failures of a unit. He is responsible for the health, welfare, morale, and discipline of personnel as well as the equipment of his command. In wartime, the commander assumes responsibility for taking and saving human lives.

Accountability is the requirement for the commander to answer to a superior (and, ultimately, the American

people) for the effective and efficient use of delegated responsibility, authority, and resources. These delegated duties ultimately affect the life of every soldier under his command.

Although ultimate authority, responsibility, and accountability rest wholly with the commander, he can delegate specific authority to staff officers to decide and to act within their own areas of responsibility. Each subordinate staff officer must understand authority, responsibility, and accountability as they relate to his relationship with the commander, other staff officers, and subordinate commanders. Most important, the staff member must always remember that he is there to support and assist his commander.

Control

Control is the promulgation of the commander's decisions, guidance, and intent with subsequent supervision and adjustment of subordinate forces' execution to ensure compliance with the commander's intent. Control may take place before, during, and after operations. Control may be exercised directly or indirectly by directive, plan, or procedure. Information and time are critical to control.

The commander, with the help of his staff, uses control to regulate forces and functions of subordinate and supporting units in military operations to ensure mission accomplishment. Control is based on situational information, such as mission, enemy, terrain, troops, and time available (METT-T), from all sources. The commander uses this information to adjust the resources, concept, or objective of the plan or to exploit success in operations. Staffs help commanders exercise control by—

- Acquiring and applying means to accomplish the commander's intent.
- Defining limits.
- Determining requirements.
- Allocating means.
- Monitoring status and performance and reporting significant changes to the commander.
- Developing specific guidance from general guidance.
- Forecasting change.

COMMAND AND CONTROL (C²) SYSTEM

The command and control system is defined as the facilities, equipment, communications, procedures, and personnel essential to a commander for planning, directing, and controlling operations of assigned forces pursuant to the missions assigned. The term system is deceptive. It does not solely mean an arrangement of equipment such as a communications system. The C² system is an organization of resources the commander uses to help plan, direct, coordinate, and control military operations to ensure mission accomplishment. The result is combat effectiveness.

The resources the commander and his unit need to perform critical C² functions include—

- Personnel (staff and liaison personnel), who help the commander exercise control.
- Communications, which include communications equipment, spaced-based systems, and networks.
- Equipment, such as automation equipment to carry out command and control activities, and materials to sustain resources committed to command and control support.
- Facilities, which include a secure working environment or base for the commander and his staff (a headquarters), and an administrative and security organization to protect, sustain, and move the commander and staff.
- Procedures (including those for decision making), using multiple sources such as doctrine, tactics, techniques, regulations, and standing operating procedures (SOPs), to focus the command and staff effort.

The command and control system must be flexible, robust, survivable, and capable of providing the commander with information that allows him to perform C² functions concurrently. The commander is the center around which the C² system revolves. Any area where functions overlap normally indicates where he must focus his personal attention. The staff, using the C² system, provides the commander with the freedom to focus on the area he has deemed the most important.

Neither the commander nor his staff should consider the C² system an end unto itself. It only exists to support the commander and help him make the decisions necessary for accomplishing his mission. For example, while exercising command, a commander issues orders that

serve as input to subordinate units. As each subordinate unit plans and executes its mission, it produces feedback to its higher commander and his staff. These are the essential measures that support effective C². Command and control is continuous, and its activities are interrelated.

THE STAFF'S ROLE

The commander and his staff focus on recognizing and anticipating battlefield activities in order to decide and act faster than the enemy. All staff organizations and procedures exist to make the organization, analysis, and presentation of vast amounts of information manageable for the commander. The commander relies on his staff to get from battlefield "information" to battlefield "understanding," or situational awareness, quicker than his adversary. Once a decision is made, the commander depends on his staff to communicate the decision to subordinates in a manner that quickly focuses the necessary capabilities within the command to achieve the commander's vision or will over the enemy at the right place and time.

The primary product the staff produces for the commander, and for subordinate commanders, is understanding, or situational awareness. True understanding should be the basis for information provided to commanders to make decisions. Formal staff processes provide two types of information associated with understanding and decision making. All other staff activities are secondary. The first is situational awareness information, which creates an understanding of the situation as the basis for making a decision. Simply, it is understanding oneself, the enemy, and the terrain or environment.

The second type of information, execution information, communicates a clearly understood vision of the operation and desired outcome after a decision is made. Examples of execution information are conclusions, recommendations, guidance, intent, concept statements, and orders.

While a particular commander may focus and reorganize the staff as necessary to conform to his personal decision-making techniques or to the unique demands of a specific mission, his requirements of the staff remain the same. All staff organizations and procedures are intended to develop understanding of the commander's problem—how to use the capabilities available to decisively impose his will over a resisting enemy. The scope and complexity of military operations are too great for any one staff officer or section to meet the commander's

information needs in isolation. The staff officer who performs his mechanical staff functions, no matter how flawlessly, without understanding how commanders make decisions, is useless to his commander.

Every commander must make decisions concerning the allocation, commitment, and engagement of troops and resources. In turn, the commander must give his staff the authority to make routine decisions, within the constraints of the commander's intent, while conducting operations. The C² system is the tool by which the commander quickly distributes his decisions to his subordinate commanders.

The commander rigorously trains his staff, shaping them into a cohesive group that can work together to understand what information he deems important. Staff officers must be able to anticipate the outcome of current operations to develop concepts for follow-on missions. They must also understand and be able to apply commonly understood doctrine in executing their missions.

BATTLEFIELD VISUALIZATION

Battlefield visualization is the process whereby the commander develops a clear understanding of his current state with relation to the enemy and environment, envisions a desired end state, and then visualizes the sequence of activities that will move his force from its current state to the end state. In short, it provides the key to where and how the commander can best lead and motivate soldiers, and see the battlefield, his own forces, the enemy, and the end state.

It is critical to mission accomplishment that commanders have the ability to visualize the battlefield. Therefore, in his intent statement, the commander must clearly articulate his battlefield visualization to his subordinates and staff to ensure the optimum development and execution of his concept of operations.

The staff assists the commander with his battlefield visualization by collecting, processing, analyzing, and transforming data into knowledge, allowing the commander to apply his judgment to achieve understanding of the situation in the form of his vision. The staff then helps him communicate his battlefield visualization to his subordinates by preparing orders and informational products to achieve a relevant common picture and situational awareness. An information network must be in place and operating to support battlefield visualization.

Chapter 2

STAFF ORGANIZATION

This chapter provides the basic foundation of staff organizations from battalion through corps. Staff structures and organizations, within the limitations of regulations and laws, often reflect the commander's operational requirements, experience, and span of control. The Army uses standardized staff organizations to benefit from consistency in performance, responsibilities (regardless of unit type or echelon), training, and resources.

BASIS FOR STAFF ORGANIZATIONS

Military staffs are organized according to the following interrelated considerations:

- Mission.
- Broad fields of interest.
- Regulations and laws.

The *mission* determines activities units are to accomplish. These activities, in turn, determine how the commander organizes, tailors, or adapts the staff to accomplish the mission.

Regardless of the command mission, every Army staff has common *broad fields of interest* that determine how the commander divides duties and responsibilities. Grouping related activities allows an effective span of control and unified effort. Broad fields of interest include—

- Personnel (G1) (S1).
- Intelligence (G2) (S2).
- Operations and training (G3) (S3).
- Logistics (G4) (S4).
- Civil-military operations (G5) (S5).
- Signal operations (G6) (S6).
- Resource management (RM).

The broad fields of interest may vary, depending on the echelon of command, the mission, and the environment. For example, at the battalion level there is not a

resource manager. The commander, however, adds the field of interest to other echelons when resource management is a major consideration.

Army *regulations and laws* establish special relationships between certain staff officers and the commander. For example, AR 20-1, AR 27-1, and AR 165-1 require the inspector general (IG), the staff judge advocate (SJA), and the chaplain to be members of the commander's personal staff.

FACTORS AFFECTING STAFF ORGANIZATIONS

Each commander must use his professional knowledge, experience, and leadership style to develop and efficiently and effectively organize his staff. Several factors influence staff organization, including the—

- Size and diversity of responsibilities.
- Political requirements.
- Local (unique) requirements.
- Changes in the amount of work the section must routinely perform.
- The amount of information dissemination the section routinely conducts.
- The availability, knowledge, qualifications, and performance of personnel.
- Requirements imposed by the organization and location of command posts and headquarters.
- A section's mobility requirements.
- Requirements for 24-hour operations.
- Requirements for 24-hour local security.
- Ability to group related activities.
- Desired span of control.
- Demand for prompt dissemination of essential information.
- Commander's and chief of staff's preferences.

AUTHORIZATION FOR STAFF ORGANIZATIONS

Every organization and activity must have an authorization document to reflect an organizational structure supportable by manning and equipping systems. An authorization document states a unit's approved structure and resources and is the basis and authority for requisitioning. Every staff has a modified table of organization and equipment (MTOE) or a table of distribution and allowances (TDA), or a combination of both that authorizes the staff.

An MTOE is a unit's wartime authorization document. The commander develops the MTOE from the table of organization and equipment (TOE). The TOE prescribes the organizational structure, personnel, and equipment authorizations and requirements of a military unit. Because of a unit's specific mission, the environment, or other reasons, the TOE is modified into an MTOE. An MTOE prescribes, in more detail, the unit's organization, personnel, and equipment authorized to accomplish the doctrinal mission in a specific geographical or operational environment or at a specific point on its modernization path. An MTOE lists authorized staff sections, personnel, and equipment. The commander can change the MTOE with Department of the Army (DA) approval.

A TDA is an authorization document. The TDA prescribes the organizational structure for a unit having a support mission or function for which a TOE does not exist and which may include civilian positions. TDAs are unique authorization documents. They help the staff attain the most efficient operational capability possible, using manpower spaces the command force structure prescribes, to accomplish specific missions and functions. Types of TDA documents include mobilization, augmentation, and full-time support TDAs.

NOTE: See FM 100-11 for a discussion of authorization documents.

BASIC STAFF STRUCTURE MODEL

Staffs at every echelon of command are structured differently, but every staff has some commonalities. The basic model for all staff structures includes a chief of staff (CofS) or executive officer (XO) and three staff groups: coordinating, special, and personal. The number of coordinating, special, and personal staff officers

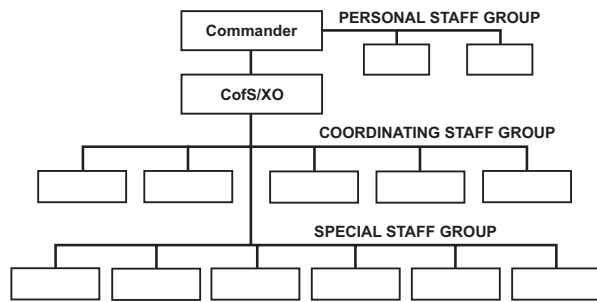

Figure 2-1. Staff structure model

within each staff group varies at different levels of command. The commander may integrate TDA staffs with MTOE staffs to promote unity of effort and to save resources. Figure 2-1 depicts the basic staff model.

Chief of Staff (Executive Officer)

The CofS (XO) is the commander's principal staff officer. He directs staff tasks, conducts staff coordination, and ensures efficient and prompt staff response. The CofS oversees coordinating and special staff officers. He does not necessarily oversee the commander's personal staff officers, although he normally interacts with them every day. The commander normally delegates authority to the CofS for the executive management of coordinating and special staff officers.

Coordinating Staff Group

Coordinating staff officers are the commander's principal staff assistants and are directly accountable to the CofS. Coordinating staff officers are responsible for one or a combination of broad fields of interest. (See Chapter 4 for specific responsibilities and duties.) They help the commander coordinate and supervise the execution of plans, operations, and activities. Collectively, through the CofS, they are accountable for the commander's entire field of responsibilities. The staff is *not* accountable for functional areas the commander decides to personally control.

Commanders may designate coordinating staff officers as assistant chiefs of staff (ACofSs), deputy chiefs of staff (DCofSs), directors, or regular staff officers. These positions generally reflect the degree of authority the commander delegates to coordinating staff officers and the scope and complexity of operations within a command. However, the commander establishes a staff officer's actual authority if it is not inherent in his title.

A coordinating staff officer's authority is limited to advising, planning, and coordinating actions within his field of interest. He also coordinates and integrates appropriate special staff officer activities into operations. The commander might also give a coordinating staff officer added authority to act on specific matters within his field of interest.

Directors have staff and line authority. For example, the director of logistics operations might be responsible for operating support activities in addition to his normal responsibilities. Typically, a commander might delegate significant responsibility and authority to a director to enable him to accomplish specific functions.

Normally, coordinating staff officers have a direct interest in other staff officers' fields of interest. Therefore, a clear definition of staff responsibilities is necessary to ensure coordination and to eliminate conflict. Unit SOPs or organization and functions manuals give procedures that specify primary responsibilities and requirements for coordination.

Coordinating staff officers are responsible for acquiring information and analyzing its implications for and impact on the command. More important, coordinating staff officers must provide timely and accurate recommendations to the commander to help him make the best possible decisions. While doing so, coordinating staff officers must often request and receive information and recommendations from special staff officers. However, they must be sure to inform all other coordinating staff officers, as required.

NOTE: A coordinating staff officer working for a general officer is normally designated as a "G" staff officer. For example, the ACofS for operations, G3, normally is at corps, corps support command (COSCOM), and division levels. At division support command (DISCOM), regiment, brigade, and battalion levels, the operations officer is designated as the S3.

Special Staff Group

Special staff officers help the commander and other members of the staff in their professional or technical functional areas. The specific number of special staff officers and their duties vary at each level of command. Special staff sections are organized according to functional areas. For example, the fire support coordinator (FSCOORD) is the staff officer whose functional area is fire support and artillery. In some cases, a special staff officer is a unit commander, for example, a division

artillery commander or an engineer brigade commander at division or corps.

The commander assigns responsibilities to specific coordinating staff officers for each of the special staff functions. Although special staff sections may not be integral to a coordinating staff section, there are usually areas of common interest and habitual association. Therefore, a coordinating staff officer might be responsible for coordinating a special staff's actions. For example, at division level the G3 coordinates all matters relating to fires and engineers with the FSCOORD, the engineer coordinator (ENCOORD), the air/naval gunfire liaison company (ANGLICO) commander, the aviation coordinator (AVCOORD), and the air liaison officer (ALO).

Other special staff officers may deal routinely with more than one coordinating staff officer. For example, provost marshal (PM) functions are operationally aligned under the G3, but he coordinates with the G1, G2, G4, and G5.

Personal Staff Group

Personal staff members work under the commander's immediate control. They also may serve as special staff officers as they coordinate actions and issues with other staff members. When performing their duties as special staff officers, these personal staff officers may work through the CofS and under a specific coordinating staff officer for coordination and control purposes. Members of the personal staff include—

- Personnel the TOE or TDA specifically authorizes as personal assistants, such as aides-de-camp.
- Personnel the commander desires to supervise directly.
- Personnel who by law or regulation have a special relationship to the commander.

Typical personal staff members include the command sergeant major (CSM), chaplain, inspector general (IG), public affairs officer (PAO), surgeon, dentist, and staff judge advocate (SJA). Members may perform some duties as personal staff officers and some as special staff officers or members of a coordinating staff section. For example, the SJA is also responsible for his staff section's operations.

STAFF MODELS

All Army staff organizations at corps through battalion levels use a basic model to begin the organization of

their staffs (Figure 2-1). Each commander then tailors his staff according to his specific needs. Whether the staff is called a G staff or an S staff depends on who is in command. A unit commanded by a general officer has a G staff. A unit commanded by a colonel or below has an S staff.

Major Commands (G Staffs) (Corps and Division)

Figure 2-2 shows the typical staff organization for a corps or division. The staff of a major command has each of the major staff groups: coordinating, special, and personal staff officers. (See Chapter 4 for the duties and responsibilities of each of these officers.)

In a corps or division, the deputy or assistant commander extends the commander's span of control in areas and functions as the commander designates. The deputy or assistant commander's specific duties

vary from corps to corps and division to division, but typically include rear operations or a special operation in conjunction with close operations.

A division normally has two assistant division commanders (ADCs) to extend the division commander's control in designated areas and functions. The ADC's specific duties also vary from division to division. Typical duties might include being the ADC for maneuver or operations or the ADC for support.

Staffs of Smaller Units (S Staffs) (Regiments, Brigades, and Battalions)

The staffs of smaller units are organized according to the basic staff model. Their coordinating staff officers control functional areas of interest more suited to their unit's mission. The staffs of units smaller than division must meet unit requirements. Figure 2-3 depicts a typical smaller-unit staff structure. (See Chapter 4 for the duties and responsibilities of each staff officer.)

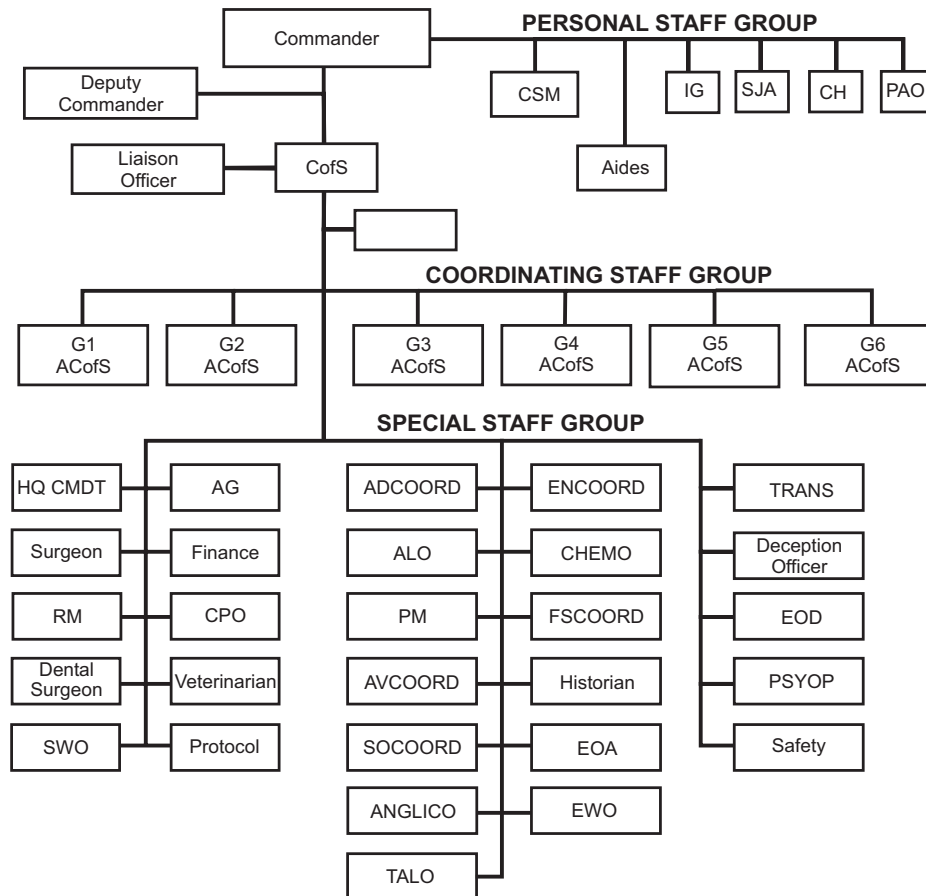
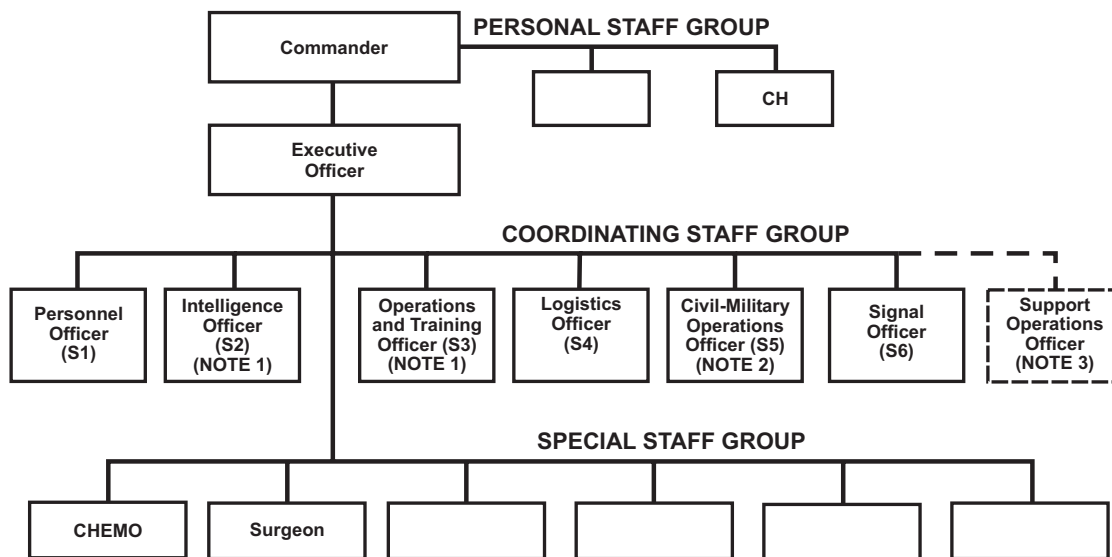

Figure 2-2. Typical corps or division staff structure



NOTES: For brigades and battalions not authorized a specific special staff officer, the commander appoints an officer to perform the function as an additional duty, if required. The command may form other staff groups when DA or the theater commander authorizes.

1. In CSS units, the functions of the S2 and S3 are usually consolidated.
2. In units where the TOE or TDA does not authorize an S5, the commander gives an officer (usually the S3) the responsibility for civil-military operations (CMO) functions.
3. In support battalions, a support operations officer is added to the coordinating staff.

Figure 2-3. Typical smaller-unit staff structure (brigade and battalion)

Smaller-unit staff functions are generally the same as those for larger staffs. However, the operational nature of smaller units might require some modification. For example, staff activities, such as advising, planning,

coordinating, and supervising, are more informal at small units than at higher levels. The functional area of interest should remain, however, even when the function is absent.

Chapter 3

CHARACTERISTICS OF A STAFF OFFICER

This manual addresses staff officers at every echelon of command, from battalion through corps. Every officer will be assigned to staff duty several times throughout his career, serving under many different commanders in a variety of staff positions.

The staff officer's duty is to assist the commander in accomplishing the mission. He relieves the commander of routine and detailed work and raises to the commander those things that only the commander can act on. The staff officer's character (values, attributes, and skills) and competence are crucial in all that the command accomplishes.

A commander always retains the ultimate responsibility to make the final decision. The staff officer's job is to accomplish the commander's intent by operating within his assigned authority to perform the duties in his area of expertise. He must ensure the commander has been provided the necessary, timely, and correct information to make the right decisions.

Each staff officer accomplishes his mission for the commander differently, but the characteristics discussed in this chapter are common among successful staff officers. The list provided in Figure 3-1 is not complete but addresses some of the more important characteristics. This chapter can provide the commander and staff officers the basis for discussion in counseling sessions for professional development and growth and serves to identify what the commander expects of his staff officers.

CHARACTERISTICS

The professional qualities found in FM 100-1 and FM 22-100 serve as the necessary foundation for all officers. The following paragraphs discuss qualities that are specifically important to staff officers.

Competence

Every staff officer has to be competent in all aspects of his position and know his specific duties and responsibilities better than anyone else. He also must be familiar with the duties of other staff members to accomplish vertical and lateral coordination to reach the best recommendation for the commander. The commander expects

the staff officer to properly analyze each problem and know, not guess at, the correct answer to make a recommendation. The staff officer must have the moral courage to admit when he does not know the correct answer to any question.

Initiative and Judgment

A staff officer must have the initiative to anticipate requirements. He must also use good judgment to size up a situation quickly, determine what is important, and do what needs to be done. He cannot wait for the commander to give specific guidance on when and where to act. He must anticipate what the commander needs to accomplish the mission and the questions the commander will ask in order to make an informed decision. He must know the commanders' intent two levels up and always operate within the commanders' intent. He should not hesitate to take advantage of a window of opportunity to accomplish the mission in the commander's absence, but he must always ask himself the question, "Is this what the commander would tell me to do if he were here?" He then must report his actions to his commander at the earliest opportunity.

A good staff officer should possess and demonstrate—

- Competence
- Initiative and judgment
- Creativity
- Flexibility
- Confidence
- Loyalty

In addition, a good staff officer should be—

- A team player
- An effective manager
- An effective communicator

Figure 3-1. Characteristics of a staff officer

Creativity

A commander is always looking for new and innovative solutions to problems. The staff officer must be creative in researching solutions to difficult and unique situations. Creative thinking and critical reasoning are skills that aid the staff officer in developing and analyzing, respectively, courses of action. If he cannot recommend a course of action in one direction or area, he must find an alternative. He must be a team player and use the creativity of all the members of the staff and command. A staff officer must always give the commander a recommended course of action. He must seek ways to support subordinate units and should not say “no” to a subordinate unit commander unless he has cleared that with his commander.

Flexibility

A staff officer must have the maturity and presence of mind to keep from becoming overwhelmed or frustrated by changing requirements and priorities. A commander will frequently change his mind or direction after receiving additional information or a new requirement from his commander. More frequently than not, the commander will not share with the staff officer why he suddenly changed his mind. The staff officer must remain flexible and adjust to the needs and desires of the commander. A staff officer must also remain flexible as he is drawn in different directions, by different superiors. He must be a master at prioritization when there are more tasks to accomplish than time available. In addition, he must learn to juggle multiple commitments simultaneously. It is essential that the staff officer meet suspenses on time because both the commander and other members of the staff are depending on his input to the problem-solving process. He must meet the suspenses or inform the commander, in advance of the suspense time, and ask for a time or priority adjustment.

Confidence

A staff officer must have the mental discipline and confidence to understand that all staff work serves the commander, even though the commander may reject the resulting recommendation. The staff officer must not put in a “half effort” because he thinks the commander will disagree with the recommendation. The work of the staff officer has assisted the commander in making the best possible decision.

The staff officer must concurrently develop multiple sides of an issue, even though they may work counter to one another. The development of courses of action must not bias the evaluation criteria that will be used later to distinguish the courses of actions. The staff officer must give the commander an unbiased look at a problem and the best possible solution to remedy it.

A staff officer must understand that often a 5-minute answer for the commander may require 10 hours of staff work. Some staff officers may conclude the investment of time is not worth the return. On the contrary, the staff officer has done what is required and expected of him and he has relieved the commander of the tedious task of detailed research. Further, the research he has done to collect data for the commander is a form of professional development, giving him confidence and experience in making future decisions as a staff officer, or as a commander himself. During a crisis, he can rely on his knowledge of what works and what doesn't.

Loyalty

FM 22-100 discusses the different loyalty demands each officer encounters during his military career. The loyalty a staff officer has with his commander is a special one. Additionally, the staff officer has loyalty to the individual soldier.

The staff officer must be loyal to the commander. Adherence to loyalty will help the staff officer tell the commander the right information rather than what he thinks the commander wants to hear. The staff officer must have the moral courage to tell the commander the “good” and “bad” news. The old adage “bad news never gets better with age” is appropriate for every staff officer.

The staff officer must also be loyal to the soldier. Any staff work, whether it is an operation plan (OPLAN) or a training event, will eventually affect the soldier. The soldier will have to execute the recommendation of the staff officer if the commander approves the recommendation. The staff officer must never forget how his recommendation will affect the soldier.

Team Player

The staff officer must be a team player. He cannot complete staff actions and staff work in a vacuum; he must advise, consult, and cooperate with others. He must be prepared to represent another's decisions as if they were his own. A wise staff officer should also

maintain a pleasant disposition because it will help achieve results which he could not otherwise obtain.

Effective Manager

The staff officer must have the ability to effectively manage time and resources. Time will always be critical. He must think not only about his time, but the time needed by other staff members, subordinate units, or anyone else who participates in the staff officer's collection, processing, or dissemination of information, or the making of recommendations. The staff officer must recognize all projects cannot be an "A" or a "B" priority. He should be capable of setting reasonable suspenses which allow completion of a "C" product.

The staff officer must be a good steward of the resources (people, environment, and money) that the country entrusts to his care. He must be diligent in his efforts to efficiently manage these resources and preserve the environment. This means avoiding waste, destruction, and duplication of effort.

Effective Communicator

The staff officer must be an effective communicator. Effective communication is crucial for the staff officer. The staff officer must clearly articulate orally, in

writing, and visually (with charts and graphs) the commander's intent and decisions. The staff officer must be skilled in orally briefing individuals and groups. He must know and understand proper briefing techniques and be able to convey complex information so that it is easily understood.

The staff officer must be able to write effectively. He must articulate, in writing, the commander's intent and guidance through operation orders (OPORDS), OPLANS, staff studies, staff summaries, and reports.

The staff officer must be able to use productively current computer technology. This includes producing visual briefing products such as charts, graphs, and slides, or other multimedia briefing products, to assist in communicating the commander's intent or desires. He should also be proficient in using computer technology such as word processing, electronic mail, and other available resources to more efficiently manage his time and to solve problems.

The staff officer frequently prepares briefings or written products for the commander or another superior staff officer. The staff officer must prepare the product as if he were going to sign it or brief it himself. He must be able to transform the commander's intent and guidance into policy or to develop meaningful criteria to evaluate viable courses of action that meet this intent.

Chapter 4

STAFF RESPONSIBILITIES AND DUTIES

The commander's staff must function as a single, cohesive unit—a professional team. Each staff member must know his own duties and responsibilities in detail and be familiar with the duties and responsibilities of other staff members.

The staff must establish and maintain a high degree of coordination and cooperation, both internally and with staffs of higher, lower, and adjacent units. The staff's efforts must always focus on supporting the commander and on helping him support his subordinate units. Commanders can minimize risks by increasing certainty. The staff supports the commander by providing better, more relevant, timely, and accurate information; making estimates and recommendations; preparing plans and orders; and monitoring execution.

This chapter describes the responsibilities and duties commonly performed by staff officers assigned to the headquarters of Army units in the field from battalion through corps. Information about the responsibilities and duties of the DA staff is contained in AR 10-5. Information about the responsibilities of installation staffs is contained in AR 5-3.

This chapter first discusses the relationship and the responsibility the commander, deputy commander, and chief of staff have with and to the staff. Next, it discusses the common duties and responsibilities of staff officers. Finally, it describes the specific responsibilities and duties commonly performed by coordinating staff officers, special staff officers, and personal staff officers.

THE COMMANDER-STAFF RELATIONSHIP

The commander makes and communicates decisions to several people, but this manual describes his communication of decisions and intentions to his staff. He also provides his staff leadership, direction, and guidance. The commander may personally communicate his intent or decisions, either verbally or in writing, or he may relay information to his staff through orders, commander's guidance, and other means.

The commander is responsible for all that his staff does or fails to do. He cannot delegate this responsibility. The final decision, as well as the final responsibility, remains with the commander. The commander must foster an organizational climate of mutual trust, cooperation, and teamwork.

When the commander assigns a staff member a mission, he also delegates the necessary authority for the staff member to accomplish the mission. Having delegated the authority to the staff member, the commander must provide the staff member with the guidance, resources, and support necessary to accomplish the mission.

The commander is responsible for training the staff. He may delegate routine staff training to the chief of staff, but the commander must train the staff to relay information and perform the mission to conform to his leadership style. The staff is an extension of the commander. The staff must know his leadership style and understand his intent to best support him, and subordinate, adjacent, and higher headquarters.

DEPUTY OR ASSISTANT COMMANDER-STAFF RELATIONSHIP

(Corps, Division, Regiment, and Separate Brigades)

The relationship between the deputy or assistant commander and the staff is unique. Staff members do not work for the deputy or the assistant commanders unless the commander directs this relationship. Each commander must describe his deputy or assistant commander's roles, duties, and relationships with the CofS, the staff, and the commanders of subordinate units. Normally, he assigns specific fields of interest and responsibility to his assistants to decentralize decision making while maintaining overall command.

Because deputy or assistant commanders must be able to assume command at any time, the commander must inform them of his battlefield vision and intent. The CofS must continually provide them with information concerning staff actions.

Deputy or assistant commanders normally do not have coordinating or special staffs. When they have specific responsibilities, the headquarters staff assists them as the commander prescribes. Deputy or assistant commanders give orders to the CofS (or the staff) within limits the commander prescribes. They may go to the CofS at any time for staff assistance. If a deputy or assistant commander needs a staff, the commander may detail officers from the headquarters or subordinate units to help him or make a subordinate unit's headquarters available to him.

At corps and major support command levels, there is normally only one deputy or assistant commander. At division level, there are normally two assistant commanders—the assistant division commander for maneuver (ADCM) or operations (ADCO), and the assistant division commander for support (ADCS). At regiment, brigade, and battalion levels, the executive officer is normally the commander's deputy or assistant commander. At this echelon of command, the executive officer also leads the staff. Along with the duties as the second in charge, he has the duties and responsibilities of the chief of staff, discussed next.

CHIEF OF STAFF (EXECUTIVE OFFICER)-STAFF RELATIONSHIP

The CofS (XO) is the commander's principal assistant for directing, coordinating, supervising, and training the staff, except in areas the commander reserves. The commander normally delegates executive management authority (equivalent to command of the staff) to the CofS. The CofS frees the commander from routine details and passes pertinent data, information, and insight from the staff to the commander and from the commander to the staff.

The value of a close and special relationship between the commander and the CofS cannot be overstated. The CofS must be able to anticipate battlefield events and share with the commander a near-identical battlefield vision of operations, events, and requirements. He must understand the commander's intent better than, or at least as well as, subordinate commanders. The CofS must understand the commander's personality, style, and instincts as they affect the commander's intentions. Staff members must inform the CofS of any recommendations or information they pass directly to the

commander or of instructions they receive directly from the commander.

The CofS helps the commander control subordinate units in their preparing for future employment. He monitors their combat readiness status and directs actions that posture subordinate units for use by the commander. Under special conditions or missions, the commander may give the CofS temporary command of a portion of the force (such as in deployments, retrograde operations, and obstacle crossings, or when the commander and deputy or assistant commanders are unable to command).

A CofS is located at corps, division, and major support command echelons and other units commanded by a general officer. The XO, performing the duties of the CofS, is located in units not commanded by a general officer (regiment, brigade, and battalion). Listed below are the areas and activities that are the responsibility of the chief of staff or executive officer in the role as supervisor of the staff. The CofS (XO) is responsible for—

- Integrating and synchronizing the warfighting plans.
- Managing the commander's critical information requirements (CCIR).
- Establishing, managing, and enforcing the staff planning time line in accordance with the commander's guidance.
- Supervising the targeting, deep operations, and other cross-forward line of troops (FLOT) planning cells.
- Integrating deception planning and fratricide countermeasures into the plan.
- Determining liaison requirements, establishing liaison information exchange requirements, and receiving liaison teams.
- Directly supervising the main command post (CP) and headquarters cell, including displacement, protection, security, and communications.
- Monitoring staff's discipline, morale, and combat and mobilization readiness.
- Organizing, planning, and conducting staff training.
- Supervising all tasks assigned to the staff.

- Directing the efforts of coordinating and special staff members.
- Ensuring staff work conforms to the mission and the commander's guidance and occurs within the time frame provided by the commander.
- Ensuring the staff integrates and coordinates its activities internally, vertically (with higher headquarters and subordinate units), and horizontally (with adjacent units).
- Informing the commander, deputy or assistant commanders, other primary staff members, and the CofSs of subordinate units about new missions, instructions, and developments.
- Directing and supervising the staff's planning process. (See Chapter 5 for a complete discussion of the staff-planning process.)
- Ensuring all staff members provide intelligence preparation of the battlefield (IPB) input to the G2.
- Maintaining knowledge of all directives, orders, and instructions the commander issues to the staff, subordinate commanders, and subordinate units, and verifying their execution.
- Ensuring the staff is rendering assistance to subordinate commanders and staffs, as necessary.
- Supervising the integration of risk management across the entire staff for all planning and execution of operations.
- Coordinating staff responsibility for the following special staff officers:
 - Headquarters commandant.
 - Secretary of the general staff (SGS).
 - Liaison officers (LNOs).

STAFF ACTIVITIES

Staff activities focus on the purpose of the staff—to assist the commander. This is accomplished mainly by staff contributions to the timely making and executing of decisions. The commander and staff should be continually alert to opportunities to streamline cumbersome or time-consuming procedures. Staff activities must contribute to mission accomplishment and the procedures employed must be the means to accomplish the mission in an effective manner—not ends in themselves.

- **Advising and providing information to the commander.**
- **Preparing, updating, and maintaining staff estimates.**
- **Making recommendations.**
- **Preparing plans and orders.**
- **Monitoring execution of decisions.**
- **Processing, analyzing, and disseminating information.**
- **Identifying and analyzing problems.**
- **Conducting staff coordination.**
- **Conducting training.**
- **Performing staff assistance visits.**
- **Performing risk management.**
- **Conducting staff inspections.**
- **Conducting staff writing.**
- **Conducting staff research.**
- **Performing staff administrative procedures.**
- **Supervising staff section and staff personnel.**

Figure 4-1. Common staff duties

COMMON RESPONSIBILITIES AND DUTIES

The following paragraphs discuss the responsibilities and duties that all staff members have in common. (See also Figure 4-1.)

Advising and Providing Information to the Commander

The staff continuously provides information to the commander, sometimes before and sometimes after the information has been analyzed. This information is not necessarily provided to make an immediate decision, but to keep the commander abreast of the situation or "big picture." This is critical during the battle. The staff must continuously feed the commander information on the progress of the battle. One piece of information alone may not be significant, but added to others, it may be the information that allows the commander to formulate the big picture and to make a decision. Commanders and staff must always remember that they are often required to work multiple issues at the same time. Information

must be set into the proper frame of reference and be relevant to prevent wasting staff officers' and commanders' time. Examples of information staff members provide include—

- Advising the commander and staff on capabilities, limitations, requirements, resource availability and employment, and all matters that deal with their areas of interest.
- Advising the commander on the readiness status of their areas of interest.
- Helping the commander see the battlefield.
- Advising the commander and staff on the capabilities, limitations, and employment of supporting forces within their areas of interest.
- Informing and advising the commander of directives and policy guidance from higher headquarters dealing with their areas of interest.

Preparing, Updating, and Maintaining Estimates

The staff prepares estimates to assist the commander in decision making. A staff estimate consists of significant facts, events, and conclusions (based on current or anticipated situations) and recommendations on how available resources can be best used and what additional resources are required. The commander uses recommendations to select feasible courses of action for further analysis. Adequate plans hinge on early and continuing estimates by staff officers. Their failure to make or update these estimates may lead to errors or omissions in the development of a course of action. An example is staff officers maintaining a current estimate of the situation in their areas of interest, in coordination with other staffs.

NOTE: A complete discussion of staff estimates is in Appendix C.

Making Recommendations

Staff officers make recommendations to assist the commander in reaching decisions and establishing policies. Staff officers also offer recommendations to one another and to their subordinate commanders. These recommendations are for information and assistance only.

Recommendations may be presented as written estimates or studies, or they may be presented orally. Whether the procedures are formal or informal, staff

officers must carefully analyze and compare all feasible alternatives using the best information available. They must candidly and objectively present the alternative to the commander clearly showing the advantages and the disadvantages. They must be thoroughly prepared to recommend a best alternative to the commander. Their preparation includes coordinating with the staff officers whose areas of interest will be affected by the recommendation. The recommendations are stated in a form that requires only the commander's approval or disapproval. Examples of staff officers' recommendations include—

- Recommending command policy and guidance concerning their areas of interest, to include capabilities, limitations, and employment.
- Recommending to the commander policies and procedures to enhance capabilities in their areas of interest.
- Recommending to the commander (or tasking when they have been delegated such authority by the commander) the allocation of scarce assets or resources to support operations in their areas of interest.
- In coordination with the G3 (S3), recommending to the commander the priorities for the employment, distribution, and support in their areas of interest.
- Recommending priorities, risk, and command and support relationships between units to the commander.
- Recommending organization for combat for their areas of interest.
- Recommending the organization for combat, allocations to subordinate units, and command and support relationships between subordinate units and organic units in their areas of interest.
- Recommending the allocation of resources and synchronizing the employment of all organic and supporting units to support the scheme of maneuver in their areas of interest.
- Recommending use of assets of other services for their areas of interest and advising liaison representatives from supporting services.
- Planning and recommending missions dealing with their areas of interest.
- Recommending to the G3 (S3) the general location and movements of units under their areas of interest.

Preparing Plans and Orders

The staff prepares and issues plans and orders to carry out the commander's decisions, coordinating all necessary details. The commander may delegate authority to staff officers to issue plans and orders without his personal approval. A single staff officer is assigned the responsibility for preparing and publishing a plan or order. Other staff officers prepare elements of the plan or order in their areas of interest. (Plans and orders are discussed in Appendix H.) Examples include—

- Formulating the concept of operations and concept of support in line with the commander's intent in their areas of interest.
- Identifying specified and implied tasks to support the plan.
- Developing the scheme of maneuver to support the course of action (COA).
- Adjusting plans according to feedback.
- Preparing that area of interest portion of the command training plan and exercising staff supervision over the execution of training in their areas of interest.
- Identifying constraints.
- Preparing, authenticating, and distributing their portion of the command SOP, operation plans (OPLANs), operation orders (OPORDs), annexes, estimates, appendixes, support plans, command training plan, reports, studies, and summaries.
- Using the results of war gaming.

Monitoring Execution of Decisions

The staff assists the commander by ensuring that subordinates carry out the commander's decisions. Staff supervision relieves the commander of much detail, keeps the staff informed of the situation, and provides the staff with the information needed to revise estimates and to provide progress reports to the commander as plans and orders are implemented. Staff officers ensure that decisions reach the intended recipients, that decisions are understood, and that decisions are executed within the commander's intent. They also initiate recommendations for modifications and elaborations when circumstances demand. Supervision is accomplished through analyzing reports, messages, and staff visits. Actions by staff members include—

- Monitoring the execution of instructions, plans, and orders in their areas of interest.

- Ensuring that organic, assigned, and supporting units accomplish tactical-level missions in support of the ground commander's scheme of maneuver in their areas of interest.

- Formulating and supervising policies concerning operations in their areas of interest.

Processing, Analyzing, and Disseminating Information

Staff officers cannot be just data collectors and transmitters. They must have the ability to analyze and clearly articulate information. The staff collects, collates, analyzes, processes, and disseminates information that flows continuously into the headquarters. The staff rapidly processes and provides critical elements of this information to the commander and other members of the staff, particularly CCIR.

Staff officers routinely analyze matters that affect operations. Essential in an analysis is identifying problems that may affect the staff officer's area of interest or the command as a whole. Judgment and experience are major factors in the staff officer's ability to recognize problems. He should develop a systematic approach, weighing each new item of information in relation to other information at his disposal. A good approach will help him determine the significance of the information and what action, if any, is necessary.

Staff officers use many means to disseminate information. Examples are briefings, electronic mail, staff papers, reports, and summaries.

Reports and summaries are used extensively to provide information to higher, lower, and adjacent commands. Nearly every staff section prepares and distributes them. The minimum number of reports and summaries consistent with the commander's need for information should be required of the subordinate command. Actions by staff officers include—

- Submitting information and intelligence reports to the G2 (S2) concerning their areas of interest.
- Maintaining current friendly and enemy situation information, maps, and overlays.
- Providing technical assistance to the G2 (S2) in their areas of interest while studying and evaluating the enemy capabilities in their areas of interest and supporting the battlefield surveillance plan.
- Providing risk assessment input to the G3 (S3) in their areas of interest.

- Reporting information dealing with their broad areas of interest to the historian.
- Monitoring operations security (OPSEC) measures within areas of interest to comply with directives and procedures.
- Identifying host nation (HN) requirements and coordinating with the G5 (S5) on integrating HN assets in their areas of interest.
- Assessing shortfalls of occupational specialties and personnel readiness issues.
- Determining workload requirements and assessing status of their organizations in their areas of interest.
- Evaluating the effectiveness of support provided by their areas of interest.
- Identifying requirements for additional units, personnel, equipment, or support in their areas of interest.
- Determining and planning training requirements for the force as a whole in their areas of interest.
- Determining requirements for forces and equipment in their areas of interest, based on the commander's priorities and in coordination with other staff elements and subordinate commands.
- Determining the adequacy of priorities for employing units under their broad areas of interest.
- Performing review and analysis in their areas of interest to determine and enhance their effectiveness in supporting operations and achieving objectives.
- Analyzing operational effects on the environment and assessing environmental status.

Identifying and Analyzing Problems

The staff must continually identify current and future problems or issues that will affect mission accomplishment. Once a problem is identified, the staff officer must analyze what actions or coordination must take place to resolve the issue. Sometimes the staff officer will have the capability and authority to correct the problem without direction from the commander. If not, once the problem is thoroughly analyzed, the staff officer must inform the commander so that he can make the appropriate decision to resolve the issue.

Conducting Staff Coordination

Staff coordination results in making certain that "pieces" fit together in an integrated whole. Good

staff coordination requires personal initiative, a spirit of cooperation, and the genuine interest of each staff member in achieving a unified effort. Most staff actions require coordination that extends beyond the immediate command and includes higher, adjacent, lower, and supporting commands, as appropriate. Coordination is essential for four reasons: to ensure a thorough understanding of the commander's intent, to ensure complete and coherent staff actions, to avoid conflict and duplication by adjusting as needed plans or policies before their implementation, and to ensure all factors are considered.

The coordinating staff officer, under whose area of interest the action falls, has specific responsibility for coordinating that action. He frequently designates a member of his section to be the action officer for the action under consideration. The action officer and all other interested staff officers examine and correlate all subactions and resolve any conflicts. Each staff officer examines the action from his own and the commander's points of view and determines the proper action within his area of interest. The action is then presented to the appropriate approving authority for a final decision. Coordination by staff officers includes—

- Providing IPB information in their areas of interest to the G2.
- Providing direction to all other staff elements about issues and information dealing in their areas of interest.
- Maintaining close contact and exchanging information with the command and with corresponding commanders, staff officers, and sections at the higher, lower, adjacent, and supporting echelons of command.
- Coordinating with higher and adjacent commands, other services, and agencies (as appropriate), to request, receive, or provide information pertinent to their areas of interest.
- Coordinating with other staff sections.
- Coordinating with their corresponding joint staff element. (The G3 (S3) has special coordinating responsibility not only with the J3 (operations), but also the J5 (plans and policy) and the J6 (command, control, communications, and computer (C⁴) systems. The G5 (S5) has special coordinating responsibility not only with the J3, but also with the J5.)
- Providing advice and assistance to support unit commanders on matters dealing with their areas of interest.

- Coordinating with the G5 (S5) for host nation support or local civilian support in their areas of interest.
- Coordinating with the G3 (S3), higher and adjacent commands, and war campaign planners to support the battle in their areas of interest.
- Coordinating (horizontally, vertically, and with adjacent units) and integrating all activities within their areas of interest.

Conducting Training

Every staff officer must assess training requirements across the command within his respective area of interest. These requirements are then added into the overall command training plan through the operations officer. The staff officer must determine the amount and type of training and requirements for evaluating the training. This may include any technical training necessary in the command in the staff officer's area of interest. The staff officer is then responsible for planning and supervising this training within the command. Examples include—

- The G2 submits specific intelligence training requirements for individual soldiers to the G3.
- The G5 submits to the G3 specific training requirements on treatment and disposition of enemy defectors and enemy prisoners of war.
- The safety officer submits to the G3 risk management training required within the command.

In addition to above, every staff member is responsible for supporting the overall training program of the unit with expertise and resources from his area of interest. Training is discussed in Appendix K. For more information on training, see FM 25-100 and FM 25-101.

Performing Staff Assistance Visits

Staff officers visit subordinate units to get information for the commander, to observe the execution of orders or instructions, and to provide advice and assistance in their areas of responsibility. Certain designated representatives make these visits in the commander's name. The staff officer should call on the subordinate unit commander to explain the purpose of his visit. Before leaving, he should report his findings to the subordinate commander and any information he plans to take back to his staff section, chief of staff, or commander. The staff officer should

avoid interfering with the unit commander's responsibilities. If the higher commander's orders seem to have been misunderstood, the staff officer should give additional information and guidance to the subordinate commander or his staff. When the staff officer returns to his headquarters, he makes a brief oral or written report of his observations to his staff principal, chief of staff, or commander, if appropriate. The chief of staff then provides this report to other staff officers, if necessary.

Performing Risk Management

Every staff officer must integrate risk management into the planning and execution of training and operational missions. The staff officer assists the commander in minimizing unnecessary risk by increasing certainty in all operations. He uses the risk management process to assess his functional area and make control measure recommendations to reduce or eliminate risk to support the combat power dynamics of protection. Examples include—

- Applying risk management during the decision-making process to identify force protection shortcomings in operating system functions.
- Developing and implementing controls for the commander that support the mission by avoiding unnecessary risk and loss of combat power.
- Providing support to operational requirements and establishing procedures and standards that are clear and practical for each specified and implied task.

NOTE: A complete discussion of risk management is in Appendix J.

Conducting Staff Inspections

Individual officers or teams conduct staff inspections as directed by the commander. Inspections normally are conducted to determine certain conditions within a subordinate unit, such as compliance or conformity with policies and regulations. Both the positive and negative observations are noted. Before the inspection, the unit commander is informed of the nature and the purpose of the inspection. Afterward, an informal report of the inspection results is provided to the subordinate commander before the inspecting officer or team leaves. Later, a formal written report to the commander normally is prepared and a copy of the report, furnished to the inspected unit. An

example of staff officers' inspections is evaluating training within their areas of interest.

Conducting Staff Writing

Staff officers prepare a variety of written communications, particularly at division and above, where operations rely primarily on written directives, reports, orders, and studies. Writing is a means of communicating ideas to the commander, subordinate unit commanders, and other staff officers. Effective staff writing should convey the writer's exact meaning and should not be subject to misinterpretation.

Conducting Staff Research

Staff research is the collection and evaluation of facts necessary to solve problems or to provide information. Some facts are available in office records while others can be found only by examining many sources. The problem determines the research needed. Only after analyzing the problem and listing the main issues to be considered can the staff officer determine how much and what kind of information he must collect. The extent of research is the staff officer's decision. The staff officer must decide when he has the information he needs to draw valid conclusions. To be valid, conclusions must be relevant to the topic, objective, and supported by the data, and they must be arrived at through a logical thought process.

Performing Staff Administrative Procedures

Every staff officer performs administrative procedures to provide continuity for completed staff actions and to allow the staff member or staff section to efficiently and effectively accomplish its tasks. Each staff member must manage his administrative activities within his own staff section. Examples include—

- Maintaining policy files of the commander and higher headquarters.
- Maintaining current command SOP and, specifically, the internal SOP for the staff member's area of interest.
- Maintaining staff section records to provide the commander with essential information.
- Maintaining reference files for his area of interest.

Supervising Staff Section and Staff Personnel

Every staff officer must be capable of supervising his staff section personnel, including—

- Performing staff supervision of activities and units assigned, attached, or under the operational control (OPCON) of the command that come under his area of interest to ensure adequate support of the command.
- Recommending and coordinating assignments and personnel issues affecting his area of interest.
- Coordinating procurement, storage, issue, and distribution of equipment in his area of interest.
- Supporting assigned, attached, or OPCON units or individuals under the supervision of a particular staff section (such as with administration, shelter, food, and supplies).
- Acting as a staff advisor for assigned, attached, supporting, or OPCON units or personnel in his area of interest.
- Determining, planning, evaluating, and supervising specific training requirements for his staff section.
- Monitoring the maintenance, personnel, and equipment status within his area of interest and advising the commander and responsible staff.
- Organizing and supervising subelements in his area of interest.

SPECIFIC STAFF RESPONSIBILITIES AND DUTIES

This section describes the specific and unique responsibilities and duties of the coordinating, special, and personal staff groups discussed in the basic staff model in Chapter 2. The common responsibilities and duties inherent to every staff officer were discussed in the last section.

Coordinating staff officers have primary staff responsibility for several special staff officers. This section describes the relationship between these two staff groups. The coordinating staff officer establishes procedures for coordinating and integrating special staff activities within his field of interest and responsibility. This section also discusses the uniqueness of the personal staff officer who wears two hats. He is both a personal staff officer and a special staff officer, according to regulations.

Coordinating Staff Officers

Every staff has coordinating staff officers who coordinate actions for the commander and of special staff officers. Coordinating staff responsibility includes—

- Ensuring that the special staff officer or section has personnel, logistics, facilities, and proper support.
- Coordinating actions and taskings of special staff officers across the entire staff, as necessary.
- Informing the chief of staff of the special staff officer's actions.

The discussion that follows lists under each coordinating staff officer that officer's specific coordination responsibilities. Figure 4-2, page 4-18, shows the relationships between the coordinating staff and the special staff.

Assistant Chief of Staff, G1 (S1), Personnel

The G1 (S1) is the principal staff officer for all matters concerning human resources (military and civilian), which include personnel readiness, personnel services, and headquarters management. A personnel officer is located at every echelon from battalion through corps. The common staff duties and responsibilities were listed in the previous section. Following are the areas and activities that are the specific responsibility of the G1 (S1).

Manning, which involves—

- Personnel readiness management, which includes—
 - Analyzing personnel strength data to determine current combat capabilities.
 - Projecting future requirements.
- Unit strength maintenance, including monitoring, collecting, and analyzing data affecting soldier readiness (such as morale, organizational climate, commitment, and cohesion).
- Monitoring of unit strength status.
- Development of plans to maintain strength.
- Personnel replacement management, which includes—
 - Receiving, accounting, processing, and delivering personnel.
 - Advising the commander and staff on matters concerning individual replacements and the operation of the replacement system.

- Preparing estimates for personnel replacement requirements based on estimated casualties, nonbattle losses, and foreseeable administrative losses.

- Preparing plans and policies to govern assignment of replacement personnel.

- Requesting and allocating individual replacements according to G3 priorities.

- Integrating the personnel replacement plan from the G1 with the equipment replacement plan from the G4 and with the training plan from the G3.

- Coordinating and monitoring readiness processing, movement support, and the positioning of replacement-processing units.

- Planning and coordinating policies for personnel determined unfit for combat duty (for example, medical reasons).

Casualty operations management, which involves casualty reporting, notification, and assistance; line-of-duty determination; reporting of status of remains; and casualty mail coordination.

- Retention (reenlistment).
- Assessing and documenting of enemy prisoner of war (EPW) injury, sick, and wound rates.
- Deployment of civilian personnel.
- Use of civilian labor in coordination with the civilian personnel officer (CPO).
- Monitoring of the deployability of military personnel.

Health and personnel service support, which involves—

- Staff planning and supervising, which includes—
 - Morale support activities, including recreational and fitness activities.
 - Community and family support activities and programs.
 - Quality-of-life programs.
 - Postal operations (operational and technical control), including EPW mail services.
 - Band operations.
 - Awards programs.
 - Administration of discipline.

- Personnel service support, including finance, record keeping, Servicemen's Group Life Insurance (SGLI), religious support, legal services, and command information.

- Assessment of the status of morale and recommendation of programs to enhance low morale.

- Coordination of interaction with—

- Army and Air Force Exchange Service (AAFES), for example, for movies.

- Nonmilitary agencies servicing the command, such as the American Red Cross.

Headquarters management, which includes—

- Managing the organization and administration of the headquarters.

- Recommending manpower allocation.

- Coordinating and supervising—

- Movement.

- Internal arrangement.

- Space allocation.

- Administrative support.

Staff planning and supervision over—

- Administrative support for military and civilian personnel, to include leaves, passes, counseling, and personal affairs.

- Administrative support for augmentees (non-US forces, foreign nationals, civilian internees).

- Administration of discipline, and law and order (in coordination with the G3 (PM)), including absence without leave (AWOL), desertion, court martial offenses, requests for transfers, rewards and punishments, and disposition of stragglers.

- Recommending of intelligence requirements (IR) to the G2.

Coordination of staff responsibility for the following special staff officers:

- Adjutant general (AG).

- Civilian personnel officer (CPO).

- Dental surgeon.

- Equal opportunity advisor (EOA).

- Finance officer.

- Surgeon.

- Veterinary officer.

NOTE: The duties and responsibilities of these special staff officers can be found under the special staff officer section, page 4-17.

Coordination of staff responsibility for the following special and personal staff officers (when coordination is necessary):

- Chaplain.

- Inspector general.

- Public affairs officer.

- Staff judge advocate.

NOTE: When these personal staff officers are performing duties as special staff officers, the G1 is responsible for staff coordination. See the personal staff officer section, page 4-29, for the duties and responsibilities of the chaplain, IG, PAO, and SJA.

Assistant Chief of Staff, G2 (S2), Intelligence

The G2 (S2) is the principal staff officer for all matters concerning military intelligence (MI), counterintelligence, security operations, and military intelligence training. An intelligence officer is located at every echelon from battalion through corps. The common staff duties and responsibilities were listed in the previous section. Following are the areas and activities that are the specific responsibility of the G2 (S2).

Military intelligence (MI), which involves—

- Disseminating intelligence to commanders and other users in a timely manner.

- Collecting, processing, producing, and disseminating intelligence.

- Conducting and coordinating intelligence preparation of the battlefield (IPB).

- Recommending unit area of interest and assisting the staff in defining unit battlespace.

- Describing the effects of the battlefield environment on friendly and enemy capabilities.

- Evaluating the threat (their doctrine, order of battle factors, high-value targets (HVTs), capabilities, and weaknesses).

- Determining enemy most probable and most dangerous courses of action and key events.

- Coordinating with the entire staff and recommending PIR for the commander's critical information requirements.
- Integrating staff input to IPB products for staff planning, decision making, and targeting.
- Coordinating with the G3 (PM) for processing (for intelligence purposes) materials taken from EPWs and civilian internees.
- Coordinating ground and aerial reconnaissance and surveillance operations with other collection assets.
- Participating in targeting meeting.
- Debriefing personnel returning from enemy control.
- Analyzing, in coordination with the G3 (engineer coordinator (ENCOORD)), enemy capability to use environmental manipulation as a means to impede friendly forces or jeopardize long-term objectives.
- Coordinating technical intelligence activities and disseminating information.
- Assisting the G3 in planning target acquisition activities for collection of target information.
- Coordination with the chemical officer to analyze the enemy's capability and predictability of using nuclear, biological, and chemical (NBC) weapons.
- Coordinating with the G1 the enemy situation that may affect evacuation or hospitalization plans.
- Coordinating with the G4 the enemy situation that may affect logistics operations.
- Coordinating with the G5 the enemy situation that may affect civil-military operations.
- Assisting the G3 (deception officer) in preparing deception plans by recommending the target and objective based on assessed enemy collection capability and susceptibility to deception.
- Assisting the G3 in information operations, to include command and control warfare (C²W).
- Planning and managing intelligence collection operations in coordination with the G3 and fire support planners.
- Recording, evaluating, and analyzing collected information to produce all-source intelligence that answers the commander's priority intelligence requirements and information requirements (IR), including battle damage assessments (BDAs).

- Maintaining the current situation regarding the enemy and environmental factors and updating IPB and the intelligence estimate.

- Determining map requirements and managing the acquisition and distribution of map and terrain products in coordination with the G3 (ENCOORD), who is responsible for map and terrain product production.

Counterintelligence (CI), which involves—

- Identifying enemy intelligence collection capabilities, such as human intelligence (HUMINT), signals intelligence (SIGINT), imagery intelligence (IMINT), and efforts targeted against the unit.

- Evaluating enemy intelligence capabilities as they affect the areas of OPSEC, countersurveillance, signals security (SIGSEC), security operations, deceptions planning, psychological operations (PSYOP), rear area operations, and force protection.

- Conducting counterintelligence liaison for security and force protection.

- Conducting counterintelligence force protection source operations.

Security operations, which involve—

- Supervising the command and personnel security program.

- Evaluating physical security vulnerabilities to support the G3.

- Coordinating security checks for indigenous personnel.

Staff planning and supervision over the special security office.

Intelligence training, which involves—

- Preparing the command intelligence training plan and integrating intelligence, counterintelligence, operational security, enemy (organization, equipment, and operations), and intelligence preparation of the battlefield considerations into other training plans.

- Exercising staff supervision of MI support to the command's intelligence training program.

Coordination of staff responsibility for the special staff officer, the staff weather officer (SWO). (The duties and responsibilities of the SWO can be found under the special staff officer section.)

Assistant Chief of Staff, G3 (S3), Operations

The G3 (S3) is the principal staff officer for all matters concerning training, operations and plans, and force development and modernization. An operations officer is located at every echelon from battalion through corps. The common staff duties and responsibilities were listed in the previous section. The areas and activities that are the specific responsibility of the G3 (S3) follow.

Training, which involves—

- Supervising the command training program.
- Preparing and supervising the execution of training within the command.
- Preparing the training guidance for the commander's approval and signature.
- Assisting the commander in developing and training the unit's mission-essential task list (METL).
- Identifying training requirements, based on the unit's METL and training status.
- Ensuring that training requirements orient on conditions and standards of combat.
- Determining requirements for and allocation of training resources.
- Organizing and conducting internal schools and obtaining and allocating quotas for external schools.
- Planning and conducting training inspections, tests, and evaluations.
- Maintaining the unit-readiness status of each unit in the command.
- Compiling training records and reports as appropriate.

Operations and plans, which involve—

- Preparing, coordinating, authenticating, publishing, and distributing the command SOP, OPLANs, OPORDs, fragmentary orders (FRAGOs), and warning orders (WARNOs) to which other staff sections contribute.
- Planning, coordinating, and supervising exercises.
- Participating in targeting meetings.
- Reviewing plans and orders of subordinate units.
- Synchronizing tactical operations with all staff sections.

- Reviewing entire OPLANs and OPORDs for synchronization and completeness.
- Monitoring the battle.
- Ensuring necessary combat support (CS) requirements are provided when and where required.
- Coordinating with the G5 on using tactical forces to establish civil government.
- Coordinating with the G2 to write the reconnaissance and surveillance annex, which includes tasking units with available assets, to collect the commander's priority intelligence requirements.
- Recommending IR to the G2.
- Integrating fire support into all operations.
- Planning troop movement, including route selection, priority of movement, timing, providing of security, bivouacking, quartering, staging, and preparing of movement order.
- Recommending priorities for allocating critical command resources, such as, but not limited to—
 - Time (available planning time).
 - Ammunition basic loads and the controlled supply rate (CSR) of ammunition.
 - Personnel and equipment replacements.
 - Electronic frequencies and secure key lists.
- Developing ammunition required supply rate (RSR) in coordination with the G2 and G4.
- Requisitioning replacement units through operational channels.
- Establishing criteria for reconstitution operations.
- Recommending use of resources to accomplish both maneuver and support, including resources required for deception purposes.
- Coordinating and directing terrain management (overall ground manager).
- Determining combat service support (CSS) resource requirements in coordination with the G1 and G4.
- Participating in course of action and decision support template (DST) development with G2 and FSCOORD.
- Coordinating with ENCOORD, G2, G5, and surgeon to establish environmental vulnerability protection levels.

- Furnishing priorities for allocation of personnel and critical weapon systems replacement to combat units.

- Recommending the general locations of command posts.

- Recommending task organization and assigning missions to subordinate elements, which includes—

- Developing, maintaining, and revising the troop list.

- Organizing and equipping units, including estimating the numbers and types of units to be organized and the priority for phasing in or replacing personnel and equipment.

- Assigning, attaching, and detaching units, detachments, or teams.

- Receiving units, detachments, or teams, including orienting, training, and reorganizing them as necessary.

- Coordinating with the G1 (CPO) civilian personnel involvement in tactical operations.

Force development and modernization, which involve—

- Reviewing, analyzing, and recommending a planned or programmed force structure.

- Processing procedures for unit activation, inactivation, establishment, discontinuance, and reorganization (force accounting).

- Fielding new weapons and equipment systems (force modernization).

- Evaluating the organizational structure, functions, and workload of military and civilian personnel to ensure their proper use and requirements (manpower utilization and requirements).

- Allocating manpower resources to subordinate commands within established ceilings and guidance (manpower allocation).

- Developing and revising unit force data for documenting any changes to the MTOE and modification table of distribution and allowances (MTDA).

- Planning and conducting formal, on-site manpower and equipment surveys.

- Recording and reporting data for information, planning and programming, allocation, and justification (manpower reports).

- Ensuring MTDA and MTOE documents reflect the minimum-essential and most-economical equipment needed to accomplish the assigned mission. The G3 determines qualitative and quantitative personnel requirements for new equipment and systems.

Staff planning and supervision over—

- OPSEC, including analyzing the OPSEC posture of the command, determining essential elements of friendly information (EEFI) and OPSEC vulnerabilities, evaluating and planning countersurveillance operations and countermeasures, coordinating SIGSEC measures with the G6 (S6), conducting OPSEC surveys, and evaluating effectiveness of force-protection measures.

- Force protection.

- Airspace command and control (AC²).

- Information operations, to include C²W.

- Area damage control.

- Rear operations (G3 prepares the rear operations annex).

- Discipline, and law and order (coordinates with the G1 on administrative procedures dealing with discipline, law and order).

- Activation and deactivation of units.

- Mobilization and demobilization.

- Operations concerning EPWs and civilian internees, in coordination with the provost marshal.

Coordination of staff responsibility for the following special staff officers:

- Air defense coordinator (ADCOORD).

- Air liaison officer (ALO).

- Air/naval gunfire liaison company (ANGLICO) commander.

- Aviation coordinator (AVCOORD).

- Chemical officer (CHEMO).

- Deception officer.

- Electronic warfare officer (EWO).

- Engineer coordinator (ENCOORD).

- Explosive ordnance disposal (EOD) officer.

- Fire support coordinator (FSCOORD).
- Historian.
- Liaison officer (LNO).
- Provost marshal (PM).
- Psychological operations (PSYOP) officer.
- Safety officer.
- Special operations coordinator (SOCOORD).
- Theater airlift liaison officer (TALO).

NOTE: The duties and responsibilities of these special staff officers can be found under the special staff officer section.

Assistant Chief of Staff, G4 (S4), Logistics

The G4 (S4) is the principal staff officer for coordinating the logistics integration of supply, maintenance, transportation, and services for the command. The G4 (S4) is the link between the support unit and his commander plus the rest of the staff. The G4 (S4) assists the support unit commander in maintaining logistics visibility with the commander and the rest of the staff. The G4 (S4) must also maintain close and continuous coordination with the G3 (S3). A logistics officer is located at every echelon of command from battalion through corps. At brigade and battalion levels, the S4 not only coordinates activities but also executes requirements for the commander and unit. The common staff duties and responsibilities were listed in the previous section. The areas and activities that are the specific responsibility of the G4 (S4) follow.

Logistics operations and plans (general), which involve—

- Providing information on enemy logistics operations to the G2 (S2) for inclusion to IPB.
- Developing with the G3 the logistics plan to support operations.
- Coordinating with the G3 and G1 on equipping replacement personnel and units.
- Coordinating with supporting unit commander on the current and future support capability of that unit.
- Coordinating the selection and recommending of main supply routes (MSRs) and logistics support areas, in coordination with the ENCOORD, to the G3.

- Performing logistics preparation of the battlefield in coordination with support command.
- Recommending IR to the G2.
- Recommending command policy for collection and disposal of excess property and salvage.
- Participating in targeting meetings.

Supply, which involves—

- Determining supply requirements (except for medical requirements). This function is shared with the support unit commander and the G3.
- Recommending support and supply priorities and controlled supply rates for publication in OPLANs and OPORDs.
- Coordinating all classes of supply, except Class VIII (medical), according to commander's priorities. Class VIII is coordinated through medical supply channels.
- Coordinating the requisition, acquisition, and storage of supplies and equipment, and the maintenance of materiel records.
- Ensuring, in coordination with the provost marshal, that accountability and security of supplies and equipment are adequate.
- Calculating and recommending to the G3 basic and prescribed loads and assisting the G3 in determining the required supply rates.
- Coordinating and monitoring the collection and distribution of excess, surplus, and salvage supplies and equipment.
- Directing the disposal of captured enemy supplies and equipment after coordination with the G2.
- Coordinating the allocation of petroleum products to subordinate units.
- Coordinating with the G5 (S5) to support foreign nation and host nation support requirements.

Maintenance, which involves—

- Monitoring and analyzing the equipment-readiness status.
- Determining, with the support command, maintenance workload requirements (less medical).
- Coordinating, with the support command, equipment recovery and evacuation operations.
- Determining maintenance time lines.

Transportation, which involves—

- Conducting operational and tactical planning to support movement control and mode and terminal operations.
- Coordinating transportation assets for other services.
- Coordinating with G5 (S5) for host nation support.
- Coordinating with the G1 and the G3 (PM) on transporting replacement personnel and EPWs.
- Coordinating special transport requirements to move the command post.
- Coordinating with the G3 for logistics planning of tactical troop movement.

Services, which involve—

- Coordinating the construction of facilities and installations, except for fortifications and signal systems.
- Coordinating field sanitation.
- Coordinating actions for establishing an organizational clothing and individual equipment operation for exchange and for replacing personal field (TA-50) equipment.
- Coordinating or providing food preparation, water purification, mortuary affairs, aerial delivery, laundry, shower, and clothing and light textile repair.
- Coordinating the transportation, storage, handling, and disposal of hazardous material or hazardous waste.
- Coordinating unit spill prevention plans.

Staff planning and supervision over—

- Identification of requirements and restrictions for using local civilians, EPWs, and civilian internees and detainees in logistics support operations.
- Battlefield procurement and contracting.
- Coordination with SJA on legal aspects of contracting.
- Coordination with the RM officer and the finance officer on the financial aspects of contracting.
- Real property control.
- Food service.
- Fire protection.

- Bath and laundry services, and clothing exchange.
- Mortuary affairs.

Coordination of staff responsibility for the special staff officer:

- Transportation officer. (The duties and responsibilities of the transportation officer can be found under the special staff officer section, page 4-29.)

Assistant Chief of Staff, G5 (S5), Civil-Military Operations

The G5 (S5) is the principal staff officer for all matters concerning civil-military operations (the civilian impact on military operations and the impact of military operations on the civilian populace). The G5 (S5) has responsibility to enhance the relationship between military forces and civilian authorities and personnel in the area of operations to ensure the success of the mission. The G5 (S5) is required at all echelons from battalion through corps level but authorized only at division and corps levels. Once deployed, units and task forces below division level may be authorized an S5. The common staff duties and responsibilities were listed in the previous section. The areas and activities that are the specific responsibility of the G5 (S5) follow.

Civil-military operations (CMO), which involve—

- Advising the commander of the civilian impact on military operations.
- Advising the commander on his legal and moral obligations concerning the impact of military operations on the local populace (economic, environmental, and health) for both the short and long term.
- Minimizing civilian interference with combat operations, to include dislocated civilian operations, curfews, and movement restrictions.
- Advising the commander on the employment of other military units that can perform CMO missions.
- Establishing and operating a civil-military operations center (CMOC) to maintain liaison with and coordinate the operations of other US government agencies; host nation civil and military authorities; and nongovernmental, private voluntary, and international organizations in the area of operations.
- Planning positive and continuous community relations programs to gain and maintain public understanding and good will, and to support military operations.

- Coordinating with the SJA concerning advice to the commander on rules of engagement for dealing with civilians in the area of operations.
- Providing recommended CMO-related IR and EEFI to the G2.
- Coordinating with the G3 (FSCOORD) on protected targets.
- Providing the G2 operational information gained from civilians in the area of operations.
- Coordinating with the G3 (PSYOP) on trends in public opinion.
- Coordinating with the G1 (surgeon) on the military use of civilian medical facilities, materials, and supplies.
- Assisting the G1 with coordination for local labor resources.
- Coordinating with the PAO and the G3 (PSYOP) to ensure disseminated information is not contradictory.
- Coordinating with the PAO on supervising public information media under civil control.
- Providing instruction to units or officials (friendly, or host nation civil or military) and the population in identifying, planning, and implementing programs to support the civilian populations and strengthen the host nation internal defense and development.
- Identifying and assisting the G6 with coordination for military use of local communications systems.
- Providing technical advice and assistance in the re-orientation of enemy defectors, EPWs, and civilian internees or detainees.
- Participating in targeting meetings.
- Coordinating with the G3 (PM) the planning of the control of civilian traffic in the area of operations.
- Assisting the G3 with information operations.
- Identifying and assisting the G4 with coordination for facilities, supplies, and other material resources available from the local civil sector to support military operations.
- Coordinating with the G1 and SJA in establishing off-limits areas and establishments.
- Coordinating with the SJA on civilian claims against the US government.

Staff planning and supervision over—

- Attached civil affairs (CA) units.
- Military support to civil defense and civic action projects.
- Protection of culturally significant sites.
- Humanitarian civil assistance and disaster relief.
- Noncombatant evacuation operations (NEO).
- Emergency food, shelter, clothing, and fuel for local civilians.
- Public order and safety as it applies to military operations.

Assistant Chief of Staff, G6 (S6), Signal

The G6 (S6) is the principal staff officer for all matters concerning signal operations, automation management, network management, and information security. A G6 (S6) is located at all echelons of command from battalion through corps. The common staff duties and responsibilities were listed in the previous section. The areas and activities that are the specific responsibility of the G6 (S6) follow.

Signal operations, which involve—

- Managing and controlling the use of information network capabilities and network services from the power projection sustaining base to the forward most fighting platforms.
- Managing radio frequency allocations and assignments and providing spectrum management.
- Managing the production of user directories and listings.
- Recommending signal support priorities for force information operations.
- Recommending locations for command posts within information battlespace.
- Coordinating with the G5 the availability of commercial information systems and services for military use.
- Managing all signal support interfaces with joint and multinational forces, including host nation support interfaces.
- Coordinating, updating, and disseminating the command frequencies lists.
- Managing communications protocols, and coordinating user interfaces of defense information system

networks (DISNs) and command and control systems down to battalion tactical internets.

- Recommending IR to the G2.
- Internal distribution, message services, and document reproduction.
- Ensuring redundant signal means are available to pass time-sensitive battle command information from collectors to processors and between medical units and supporting medical laboratories.
- Participating in targeting meetings.

Automation management, which involves—

- Managing the employment automation (hardware, software) supporting the force, including the operations of the automation management office (AMO).
- Establishing automation systems administration procedures for all automation software and hardware employed by the force.
- Coordinating the configuration of local area networks that support the force.

Information security, which involves—

- Managing communications security (COMSEC) measures, including the operation of the Information System Security Office (ISSO) of the signal support elements.
- Establishing automation systems security for all automation software and hardware employed by the force.
- Recommending C²-protect priority information requirements.

Staff planning and supervision over—

- The command's signal support network.
- Activities of the signal office.

Support Operations Officer/Materiel Officer (Only in Support Commands/Battalions)

The support operations officer or materiel officer is the principal staff officer for coordinating logistics and combat health support to supported units. He provides the technical supervision for the CSS mission of the support command. He is the key interface between the supported unit and support command providing the support. A support operations officer or materiel officer is located in support commands and battalions. The common

staff duties and responsibilities were listed in the previous section. The areas and activities that are the specific responsibility of the support operations officer or materiel officer follow:

- Advises the commander on support requirements versus support assets available.
- Coordinates external support requirements for supported units.
- Synchronizes support requirements to ensure they remain consistent with current and future operations.
- Plans and monitors support operations and makes necessary adjustments to ensure support requirements are met.
- Coordinates with the S4 to track available combat service support assets.
- Coordinates support locations and time schedules with the S2/S3 and supported units.
- Prepares and distributes the external service support SOP that provides guidance and procedures to supported units.
- Provides input to the supported units on the logistics estimate and service support annex. Prepares external service support annex.
- Provides technical assistance to supported units.

Special Staff Officer

Every staff has special staff officers. This section addresses the specific duties of each special staff officer. Common staff duties and responsibilities were discussed earlier in this chapter. The number of special staff officers and their duties and responsibilities vary with the level of command, the authorizations, the desires of the commander, and the size of the command. If, at a given echelon, a special staff officer is not assigned, the corresponding coordinating staff officer assumes those responsibilities as necessary.

This section first lists the coordinating staff officer; the special staff officer or officers he has coordinating responsibility for are listed beneath. Figure 4-2, page 4-18, also shows this responsibility relationship.

Chief of Staff (CofS)

The following special staff officers are the coordinating staff responsibility of the CofS.

<p>G1</p> <p>AG CPO Dental Surgeon EOA Finance Surgeon Veterinarian</p> <p>NOTE: Chaplain IG PAO SJA</p>	<p>CofS</p> <p>HQ Cmdt SGS RM</p>	<p>G3</p> <p>ADCOORD ALO ANGLICO Cdr AVCOORD CHEMO Deception Officer EWO ENCOORD EOD FSCOORD Historian LNO PM PSYOP Safety SOCOORD TALO</p>
	<p>G4</p> <p>Trans Off</p>	
	<p>G5</p>	
<p>G2</p>	<p>G6</p>	

Note: The Chaplain, IG, PAO, and SJA are personal staff officers who coordinate (if necessary) through the G1 (S1) when performing special staff functions.

Figure 4-2. Coordinating staff responsibilities for special staff

Headquarters Commandant. The headquarters commandant is the special staff officer responsible for OPCON over soldiers assigned to the specific headquarters who are not assigned or attached to subordinate commands. A headquarters commandant is located at corps, division, and major support command levels. Besides his common staff responsibilities, the headquarters commandant is responsible for these areas and activities:

- Local headquarters security, to include construction of defensive positions.
- Arrangement and movement of the headquarters.
- Training and morale activities for headquarters personnel.
- Food service, quartering, medical support, field sanitation, and supply for headquarters personnel.
- Reception and accommodation of visitors and augmentees.
- Motor transportation organic to or allocated for use by the headquarters.
- Maintenance of equipment organic to or allocated for use by headquarters.

Secretary of the General Staff (SGS). The secretary of the general staff is the special staff officer who acts as executive officer for the chief of staff. There is a secretary of the general staff at corps, division, and major

support command levels or wherever there is a general officer with a staff. Besides his common staff responsibilities, the SGS's specific responsibilities are as follows:

- Plans and supervises conferences chaired by the commander, deputy or assistant commanders, or the CofS.
- Directs preparation of, and monitors execution of, itineraries for distinguished visitors to the headquarters.
- Monitors preparation and execution of all official social events and ceremonies involving the commander, deputy or assistant commanders, and the CofS.
- Acts as the informal point of contact for LNOs.

Resource Manager/Comptroller. The resource manager/comptroller is the special staff officer responsible for budget preparation and resource management (RM) analysis and implementation for the command. Resource managers/comptrollers are normally located at corps and division levels. During combat operations, comptroller functions within a theater of operations are normally transferred to theater Army or higher levels. However, specific comptroller functions may occur at corps or division levels. Besides his common staff responsibilities, the resource manager's/comptroller's specific responsibilities are as follows:

- Supervises the development, including the training resource synchronization, evaluation, revision, defense, and execution, of the command budget estimate and the program objective memorandum (POM).
- Establishes plans, policies, and procedures for developing and implementing the command's budget.
- Provides assistance to the staff on budget methods and formats; techniques of preparation, resource synchronization, presentation, and analysis; and development of workload information, expense (cost) factors, cost capturing, and statistics.
- Provides financial planning and assistance during the transition to war and throughout the conflict, including redeployment and mobilization.
- Provides fund ceilings to subordinate units.
- Monitors execution of funded programs.
- Coordinates required program budget activity meetings.
- Identifies funding sources for operations; acquires, reprograms, controls, and distributes funding

authority to subordinate resource management officers and to ordering officers.

- Oversees cost capturing for operations to support requests for funding authority for operations and requests to replace funds shifted from other programs (mission training) to support an operation.

- Provides resource stewardship, primary linkage to logistics financial system for fiscal constraints, and interface with the contracting authorities.

- Assists in contracting HN support during contingency operations and in logistics-based development as part of the contracting implementation team.

- Develops policies, procedures, and techniques to ensure the most cost-advantageous and -effective methods of purchasing commercial products and services, within fiscal and regulatory constraints.

- Monitors administrative controls for accounting and reporting receipt and disbursement of public funds, including special contingency funds.

- Develops and maintains effective financial and management controls, procedures, and systems for the best use of resources.

- Develops policies, procedures, and techniques for governing the establishment, maintenance, and operation of the command's budget accounting system.

- Implements resource control procedures and serves as the primary fund certifying officer.

- Conducts audits of certain nonappropriated funds.

- Performs chief financial officer training and reviews, and audit compliance services.

- Supervises the implementation of RM policies.

- Performs real-time audits of command systems, procedures, and internal controls to ensure their proper implementation and effective operation.

- Develops and implements an internal review program to safeguard, account for, properly use, and care for resources available for accomplishing the command's mission.

- Provides integrated and independent progress and statistical reports and analyses of command programs. Examples are qualitative evaluations of progress made in meeting programmed objectives and the effective use of resources to support rather than detract from the command's missions.

- Develops a zero-based budget using HQDA cost factors for operational tempo (OPTEMPO).

- Develops annual non-OPTEMPO requirements.

G1 (S1)

The following special staff officers are the coordinating staff responsibility of the ACofS, G1 (S1).

Adjutant General (AG). The adjutant general is the special staff officer responsible for coordinating personnel and administrative services assets and operations. The AG is the senior adjutant general officer in the force. The corps AG also serves as the personnel group commander. An adjutant general is located at corps and division levels. Besides his common staff responsibilities, the adjutant general's specific responsibilities are as follows:

- Helps the G1 prepare and maintain the current personnel estimate of the situation.

- Assesses current and projected strength data to maintain the readiness posture of units.

- In accordance with priorities established by the commander, allocates replacements to major subordinate commands.

- Performs casualty operations.

- Maintains a personnel information data base.

- Coordinates the awards program.

- Manages line-of-duty investigations, congressional and family inquiries, and special correspondence.

Civilian Personnel Officer (CPO). The civilian personnel officer is the special staff officer responsible for the management and administration of the civilian employee personnel management program. The CPO is a civilian employee and has a permanent position on the staff at division and corps levels. Besides his common staff responsibilities, the CPO's specific responsibilities are as follows:

- Advises the commander and staff and supervises within the command the management and administration of the civilian employee personnel management program.

- Has special staff and operational responsibilities for administering laws and regulations about civilian personnel management.

- Develops, with other staff officers, plans and standby directives for procurement, use, and administration of the civilian labor force and for use of local labor in foreign areas in an emergency.

- Participates, when appropriate, in negotiations with host countries on labor agreements.

NOTE: See the AR 690-series for in-depth coverage of CPO functions.

Dental Surgeon. The dental surgeon is the special staff officer responsible for coordinating dental activities within the command. A dental surgeon is located at corps and division echelons. Besides his common staff responsibilities, the dental surgeon's specific responsibilities are as follows:

- Coordinates dental activities with the command surgeon.
- Exercises staff supervision and provides technical assistance to dental activities.
- Plans and supervises the dental functions that follow:
 - The command's preventive dentistry program.
 - The maintenance of the command's oral health and readiness.
 - The maintenance of professional standards and levels of dental care and treatment.
 - The management of the panoramic X-ray (PANORAX) identification program.
 - The establishment of priorities for dental care and treatment.
 - The professional training of dental personnel.
- Develops a program for dental support of humanitarian and civilian-action operations.
- Provides advice and technical assistance in constructing, rehabilitating, and using dental facilities.

Equal Opportunity Advisor (EOA). The equal opportunity advisor is the special staff officer responsible for coordinating matters concerning equal opportunity for service members and their families. An EOA is located at every echelon of command. Besides his common staff responsibilities, the EOA's specific responsibilities are as follows:

- Advises and assists the commander and staff on all equal opportunity (EO) matters, to include sexual harassment, discrimination, and affirmative action.
- Recognizes and assesses indicators on institutional and individual discrimination and sexual harassment.

- Recommends remedies and develops affirmative action and EO plans and policies to reduce or prevent discrimination and sexual harassment.

- Monitors affirmative action and EO plans and policies.

- Collects, organizes, and interprets demographic data concerning all aspects of EO climate assessment.

- Manages or conducts all EO education and training programs within the command.

- Receives and helps process complaints; the EOA may also conduct inquiries, in accordance with commander's guidance.

- Helps plan and conduct ethnic observances.

NOTE: Further information on the duties and responsibilities of the EOA can be found in AR 600-20.

Finance Officer. The finance officer is the special staff officer responsible for coordinating and providing finance services to the command. The finance officer also is the finance unit commander. Besides his common staff responsibilities, the finance officer's specific responsibilities are as follows:

- Provides finance policy and technical guidance.
- Supervises disbursement of funds.
- Provides US and non-US pay functions involving military, Department of Defense (DOD) civilian, foreign nation, host nation, civilian internees, EPW, and travel and miscellaneous pay.
- Advises the commander and staff on the current economic situation, including the economic impact of expenditures on the local economy, the availability and status of banking facilities in the command's area of concern, and the command's currency control program.
- Performs limited funds and nonappropriated funds accounting, as determined by theater policy.
- Provides banking and currency support.
- Coordinates financial support of battlefield procurement and contracting.
- Coordinates local procurement support with the G1 (S1) for personnel and with the G4 (S4) for materials and services.
- Stations subordinate finance units with their supporting operating systems to support battlefield procurement and pay operations.

- Monitors commercial accounts, which involves payment for supplies, equipment, and services procured to support the battlefield logistics system.

- Provides family support at home station.

- Makes solatium and other claims payment in coordination with SJA.

- Supports bounty programs such as weapons for cash.

Surgeon. The surgeon is the special staff officer responsible for coordinating health assets and operations within the command. A surgeon is authorized on all staffs from battalion through corps levels. The surgeon may or may not be a medical unit commander. Besides his common staff responsibilities, the surgeon's specific responsibilities are as follows:

- Plans and supervises—

- Health education and combat lifesaver training for the command.

- Casualty evacuation.

- Combat stress control program.

- Mass casualty plan.

- Medical care of EPWs and civilians within the command's area of operations.

- Treatment and hospitalization of sick, injured, or wounded soldiers.

- Patient evacuation, including use of both Army dedicated medical evacuation (MEDEVAC) platforms (air and ground) and Air Force evacuation aircraft.

- Veterinary food inspection, animal care, and veterinary preventive medicine activities of the command, as required and in coordination with the veterinary officer.

- Preventive medicine services.

- Medical laboratory service.

- Combat health logistics, including blood management.

- Medical support of humanitarian assistance and disaster relief operations.

- Supervision and preparation of health-related reports and battlefield statistics.

- Collection and analyses of operational data for on-the-spot adjustments in the medical support structure

and for use in postwar-combat and material-development studies.

- Advises on command health services and health matters that concern the occupied or friendly territory within the commander's area of operations.

- Recommending IR to the G2 through the G1.

- Formulates the combat health support (CHS) plan.

- Coordinates with the G2 (S2) to obtain national medical intelligence reports and summaries.

- Assists in coordinating the support of the area medical laboratory in the receipt of biomedical samples and initial identification of biological warfare (BW) agents.

- Advises on the effects of the medical threat (including environmental, endemic and epidemic diseases, NBC weapons, and directed-energy devices) toward personnel, rations, and water.

- Recommends use of nondedicated transportation assets for evacuation if required.

- Submits recommendations to higher headquarters on professional medical problems that require research.

- Advises on how operations impact on the public health of personnel and the indigenous populations.

- Examines and recommends use or processing of captured medical supplies.

- Advises the command and coordinates with the G5 on public health issues involving military operations.

Veterinary Officer. The veterinary officer is the special staff officer responsible for coordinating assets and activities concerning veterinary service within the command. The veterinary officer is a veterinary corps officer. A veterinary corps officer is authorized at corps level. Besides his common staff responsibilities, the veterinary officer's specific responsibilities are as follows:

- Plans and supervises—

- Food inspection.

- Food handling and storage facilities and equipment.

- Procurement and management of veterinary equipment and facilities, including housing of animals.

- Participation of veterinary personnel and units in civil-military operations.

— Use of medical laboratory services by veterinary personnel.

- Coordinates veterinary activities with the surgeon.
- Determines the requirements for veterinary supplies and equipment.
- Prepares reports on command veterinary activities.

G2 (S2)

Staff Weather Officer. The SWO is the coordinating staff responsibility of the ACofS, G2 (S2). The staff weather officer is the special staff officer responsible for coordinating operational weather support to tactical commanders and weather service matters. The SWO is an Air Force officer, provided on request by the Air Force, normally at division and corps levels. Besides his common staff responsibilities, the staff weather officer's specific responsibilities are as follows:

- Advises the Army commander on Air Force weather capabilities, support limitations, and the ways weather information can enhance combat operations.
- Evaluates and disseminates weather data, including forecasts, warnings, advisories, and miscellaneous weather and meteorological data.
- Monitors the overall weather support mission for the commander and acts as the commander's agent to identify and resolve weather support responsibilities.
- Determines weather support data requirements.
- Advises the Air Force on the operational weather support requirements of the supported Army command.
- Participates in targeting meetings.
- Prepares climatological studies and analyzes them in support of planned exercises, operations, and commitments.
- Coordinates weather support provided to subordinate units.
- Assists Army aircraft accident investigation boards.

G3 (S3)

The following special staff officers are the coordinating staff responsibility of the ACofS, G3 (S3).

Air Defense Coordinator (ADCOORD). The air defense coordinator is the special staff officer responsible for coordinating matters concerning the planning and

employment of air defense artillery (ADA) systems, assets, and operations. The ADCOORD is the senior air defense artillery officer in the command. He is also the commander of an ADA unit supporting the command. An ADCOORD is at corps and division levels. Besides his common staff responsibilities, the ADCOORD's specific responsibilities are as follows:

- Provides early warning to the supported command.
- Disseminates air tasking order (ATO) and airspace control order (ACO) information to ADA units.
- Requests immediate airspace control measures to support air defense (AD) operations.
- Based on enemy air and missile capability assessment, recommends offensive counterair, defensive counterair, and theater missile defense targets and priorities.
- Coordinates with the G2 (S2) to ensure that surveillance and intelligence units locate enemy air support assets.
- Coordinates AD sensor management.
- Participates in targeting meetings.
- Recommends active and passive AD measures.
- Recommends IR to the G2 through the G3.
- Determines requirements and recommends use of assets to support AD efforts.
- Provides AD input to the airspace command and control plan.
- Plans and coordinates airspace with the aviation liaison officer (AVLO); air liaison officer (ALO); FSCoord; G3 (S3) air officer; and other airspace users. (ADCOORD representatives from organic ADA units may also serve as members of the AC² cell.)
- Advises the commander and staff on the impact of early warning on AD operations; plans and supervises defense early warning operations within air defense.
- Helps develop and review joint counterair rules and procedures.

Air Liaison Officer (ALO). The air liaison officer is the special staff officer responsible for coordinating tactical air assets and operations such as close air support (CAS), air interdiction, joint suppression of enemy air defense (SEAD), reconnaissance, and airlift. The ALO is the senior Air Force officer with each tactical air control party (TACP). An ALO is authorized at corps, division, and

brigade levels. Besides his common staff responsibilities, the ALO's specific responsibilities are as follows:

- Advises the commander and staff on the employment of tactical air (TACAIR).
- Operates and maintains Air Force TACAIR direction radio net and air request net.
- Transmits requests for immediate close air and reconnaissance support.
- Transmits advance notification of impending immediate airlift requirements.
- Coordinates tactical air support missions with the fire support element and the appropriate AC² element.
- Recommends IR to the G2 through the G3.
- Acts as liaison between AD units and air control units.
- Helps plan the simultaneous employment of air and surface fires.
- Supervises forward air controllers (FACs) and the TACP.
- Integrates air support sorties with the Army unit scheme of maneuver.
- Participates in targeting meetings.
- Serves as a member of the targeting cell.
- Helps the fire support officer (FSO) direct air strikes in the absence of a FAC.
- Provides Air Force input into the AC².

Air/Naval Gunfire Liaison Company (ANGLICO) Commander. The air and naval gunfire liaison company commander in the role of a special staff officer is responsible for coordinating naval gunfire or marine close air support assets and operations. The ANGLICO commander is a naval (Navy or Marine) officer. Representatives from the Navy or Marine Corps augment a US unit, multinational unit, or coalition partner unit when that unit is supported by naval gunfire or marine close air support. The ANGLICO is designed to operate at division level and below. Besides his common staff responsibilities, the ANGLICO commander in the role of a special staff officer—

- Processes requests for naval air gunfire.
- Operates the naval gunfire ground support net.

- Provides support teams to maneuver elements when Navy ships have a direct support (DS) mission.

- Helps the company FSO adjust naval gunfire in the absence of a spotter.

- Provides control and liaison associated with the ground elements of a landing force in the control and employment of naval gunfire and Navy and Marine close air support in the amphibious assault or in other types of operations when such support is provided.

- Advises on the capabilities, limitations, and employment of naval gunfire and Navy or Marine air support.

- Participates in targeting meetings.

Aviation Coordinator (AVCOORD). The aviation coordinator is the special staff officer responsible for coordinating Army aviation assets and operations. The AVCOORD is the senior aviation officer in the force. He is also the commander of an aviation unit supporting the command. The assistant or deputy AVCOORD is a permanent position on the staff representing the AVCOORD in his absence. An AVCOORD is authorized at corps and division levels. Besides his common staff responsibilities, the AVCOORD's specific responsibilities are as follows:

- Exercises staff supervision and training over Army aviation operations.

- Monitors the aviation flying-hour, standardization, and safety program.

- Helps plan and supervise Army aviation operations.

- Recommends IR to the G2 through the G3.

- Provides technical advice and assistance on the use of Army aviation for evacuation (medical or other).

- Participates in targeting meetings.

Chemical Officer (CHEMO). The chemical officer is the special staff officer responsible for the use of or requirement for chemical assets and NBC defense and smoke operations. A chemical officer is at every echelon of command. Besides his common staff responsibilities, the chemical officer's specific responsibilities are as follows:

- Recommends COAs to minimize friendly and civilian vulnerability.

- Provides technical advice and recommendations on mission-oriented protective posture (MOPP), troop-safety criteria, operational exposure guidance, NBC reconnaissance, smoke operations, biological warfare defense measures, and mitigating techniques.
- Plans and initiates, in conjunction with the surgeon, procedures to verify and report enemy first use of NBC agents.
- Assesses probability and impact of NBC-related casualties.
- Coordinates across the entire staff while assessing the impact of enemy NBC-related attacks and hazards on current and future operations.
- Coordinates with the surgeon on health support requirements for NBC operations.
- Conducts NBC IPB vulnerability analysis and recommends IR to the G2 through the G3.
- Plans, supervises, and coordinates NBC decontamination (except patient decontamination) operations.
- Supervises the nuclear and chemical accident and incident response assistance program.
- Assesses weather and terrain data to determine if environmental factors are conducive to enemy employment of weapons of mass destruction (WMD) or, at corps level, to the friendly employment of nuclear weapons.
- Predicts downwind vapor hazard and fallout patterns and their probable effects on operations.
- Predicts fallout from friendly employment of nuclear weapons and disseminates nuclear strike warning (STRIKWARN) messages when required.
- Plans, coordinates, and manages chemical and radiological survey and monitoring operations.
- Collates, evaluates, and distributes NBC attack and contamination data.
- Prepares, manages, and distributes NBC messages.
- Prepares NBC situation reports (SITREPs).
- Plans, coordinates, and manages NBC reconnaissance operations.
- Maintains and reports radiation exposure and dose status and coordinates with surgeon.
- Participates in targeting meetings.

- Estimates effect of a unit's radiation exposure state on mission assignments.
- Participates in the nuclear target nomination process (corps only).
- Estimates consumption rates of NBC defense equipment and supplies.
- Operates the NBC warning and reporting system.
- Coordinates with the G4 (S4) on logistics as it relates to chemical defense equipment and supplies, maintenance of chemical equipment, and transportation of chemical assets.
- Coordinates NBC reconnaissance assets into the reconnaissance and surveillance plan.
- Oversees construction of NBC shelters.
- Plans and recommends integration of smoke and obscurants into tactical operations.
- Conducts smoke target development.
- Plans and recommends use of flame-field expedients to supplement unit defense and existing minefields and barriers.
- Advises the commander, in conjunction with the surgeon, on possible hazards and effects of low-level hazards, such as low-level radiation and toxic industrial material.
- Advises the commander, in conjunction with the ADCOORD, on passive defense measures to assist in protecting and warning the force against missile attack.
- Advises the commander on the use of riot control agents.

Deception Officer. The deception officer is the special staff officer for coordinating deception assets and operations for the command. A deception officer is located at corps and division levels. The deception officer comes from the MI battalion or MI brigade, but is not normally the commander of the supported unit. Besides his common staff responsibilities, the deception officer's specific responsibilities are as follows:

- Exercises staff supervision over deception activities.
- Determines, with the G2, requirements or opportunities for deception operations.
- Recommends to the G3 the deception target, objective, and deception story.
- Integrates use of deception assets.

- Monitors execution of the deception plan.
- Recommends IR to the G2 through the G3.

Electronic Warfare Officer (EWO). The electronic warfare officer is the special staff officer responsible for coordinating electronic warfare assets and operations for the command. An electronic warfare officer is located at corps and division levels. Besides his common staff responsibilities, the electronic warfare officer's specific responsibilities are as follows:

- Assists in coordinating C²-attack and C²-protect concepts to support the commander's concept of the operation.
- Coordinates, prepares and maintains the electronic warfare target list, electronic attack taskings, and electronic attack requests.
- Coordinates with the G6 to deconflict frequencies and the joint restricted frequency list with EW targets.
- Coordinates with the TCAE to identify opportunities for effective targeting using jamming, deception, and PSYOP.
- Participates in targeting meeting.

Engineer Coordinator (ENCOORD). The engineer coordinator is the special staff officer for coordinating engineer assets and operations for the command. The ENCOORD is usually the senior engineer officer in the force. He is the commander of an engineer unit supporting the command. The assistant or deputy ENCOORD is a permanent staff officer representing the ENCOORD in his absence. An ENCOORD is located at corps and division levels and one is normally task-organized to maneuver brigades and battalions. Besides his common staff responsibilities, the ENCOORD's specific responsibilities are as follows:

- Plans and controls these engineer battlefield functions:
 - Mobility.
 - Countermobility (CM).
 - Survivability.
 - General engineering.
 - Topographic engineering.
- Recommends engineer organization for combat.
- Plans and coordinates with the G3 (FSCoord) on the integration of obstacles and fires.

- Advises the commander on the use of organic and nonorganic engineer assets.

- Advises the commander on the employment and reduction of obstacles.

- Advises the commander on environmental issues, coordinates with other staff officers to determine the impact of operations on the environment, and helps the commander integrate environmental considerations into the decision-making process.

- Provides a terrain-visualization mission folder to determine the terrain's effect on both friendly and enemy operations.

- Produces maps and terrain products (coordinates with the G2 for planning and distribution).

- Plans and supervises construction, maintenance, and repair of camps and facilities for friendly forces, EPWs, and civilian internees.

- Plans and coordinates with the FSCoord the use of family of scatterable mines (FASCAM).

- Plans and coordinates environmental protection, critical areas, and protection levels.

- Assists the G2 (S2) in IPB preparation, to include preparing the engineer battlefield assessment (EBA).

- Participates in the targeting meeting.

- Provides information on the status of engineer assets on hand.

- Recommends to the G4 MSRs and logistics areas based on technical information.

- Recommends IR to the G2 through the G3.

- Plans the reorganization of engineers to fight as infantry combat units when the commander deems their emergency employment necessary.

Explosive Ordnance Disposal (EOD) Officer. The explosive ordnance disposal officer is the special staff officer for coordinating the detection, identification, recovery, evaluation, render safe, and final disposal of explosive ordnance. An EOD officer is authorized at corps and division levels and will normally be dual-hatted as the EOD group, battalion, or company commander. Besides his common staff responsibilities, the EOD officer's specific responsibilities are as follows:

- Establishes and operates an EOD-incident reporting system.

- Establishes, operates, and supervises technical intelligence reporting procedures.

- Coordinates requirements for EOD support with requesting units, other Army commands, sister services, federal agencies, and multinational or coalition partners. This coordination may include arranging for administrative and logistics support for subordinate EOD units, as required.

- Monitors the supply status of, and expedites requests for, special EOD tools, equipment, and demolition materials.

NOTE: For more details on the duties and responsibilities of the EOD officer, see AR 75-15.

Fire Support Coordinator (FSCOORD). The fire support coordinator is the special staff officer for coordinating fire support and field artillery assets and operations in the command. The FSCOORD is the senior field artillery officer in the force. He is the commander of a field artillery unit supporting the force. The assistant or deputy FSCOORD is a permanent staff officer on the staff representing the FSCOORD in his absence. There is a FSCOORD with the maneuver force at every echelon of command from battalion through corps. At brigade, regiment, and below, the FSCOORD's representative is the FSO. Besides his common staff responsibilities, the FSCOORD's specific responsibilities are as follows:

- Develops, with the G3 (S3), a concept of fires to support the operation.
- Plans and coordinates fire support tasks for—
 - Supporting forces in contact.
 - Supporting the commander's battle plan.
 - Synchronizing the fire support system.
 - Sustaining the fire support system.
 - Conducting deep fires.
 - Conducting counterfires to destroy, neutralize, or suppress the enemy's indirect fire systems.
 - Conducting SEAD fires.
 - Conducting offensive counterair fires.
 - Conducting close fires.
 - Integrating nonlethal fires into the overall scheme of fires.
 - Conducting rear fires.

- Participates in the targeting meeting and produces targeting products, such as target selection standards (TSS), and high-payoff target list (HPTL).

- Plans and coordinates, through the G3 (S3), with the G2 (S2), signal officer, and EWO, the use of electronic warfare support and electronic protection as part of fire support.

- Provides information on the status of fire support systems, target acquisition assets, and field artillery ammunition on hand.

- Recommends IR to the G2 through the G3.

- Plans and coordinates with the ENCOORD for the use of air- and artillery-delivered FASCAM.

- Recommends to the G3 (S3) the field artillery ammunition required supply rate.

- Provides an estimate of the adequacy of the field artillery ammunition controlled supply rate.

- Recommends internal reallocation of the controlled supply rate for subordinate commands to match priorities for support.

- Establishes and disseminates appropriate fire support coordination measures in support of current and future operations.

- Establishes priorities and focus for counterfire radar employment.

- Coordinates for shooter to sensor for target engagement.

- Coordinates the field artillery survey within the command and with higher and adjacent commands.

- Recommends FA organization for combat.

- Coordinates positioning of fire support assets in specific area of operations.

- Nominates nuclear targets (at corps level only).

- Coordinates and synchronizes joint fire support platforms.

Historian. The historian is the special staff officer responsible for coordinating the documentation of the historical activities of the command. The historian is normally a DA civilian. A historian is at corps and division levels. Besides the common staff responsibilities, the historian's specific responsibilities are as follows:

- Prepares the unit's history.

- Supervises the command's historical activities.
- Injects historical perspective and institutional memory into unit activities.
- Collects and maintains (as soon as possible) records such as staff journals, plans and orders, and after-action reports.
- Prepares special studies or reports based on assembled historical material.
- Maintains a command historical research collection adequate to support the historical mission.
- Establishes and maintains liaison with other historians, as required.

Liaison Officer (LNO). The liaison officer is a special staff officer responsible for representing the commander at the headquarters of another unit for effecting coordination and promoting cooperation between the two units. The coordinating staff responsibility for the LNO is that of the ACofS, G3, unless designated differently by the chief of staff.

NOTE: A complete discussion of the duties and responsibilities of the LNO is in Appendix L.

Provost Marshal (PM). The provost marshal is the special staff officer responsible for coordinating military police (MP) combat, combat support, and combat service support assets and operations. The PM is the senior military police officer in the command. He is also the commander of the MP unit supporting the force. The PM augments the staff with an officer to represent him on the staff in his absence. A PM is located at corps and division levels. Besides his common staff responsibilities, the provost marshal's specific responsibilities are as follows:

- Plans and supervises—
 - Maneuver and mobility support operations, to include route reconnaissance, surveillance, circulation control, dislocated civilian and straggler control, information dissemination, and tactical and criminal intelligence collection and reporting.
 - Components of area security operations, to include activities associated with force protection, zone and area reconnaissance, and C²-protect (access control; physical security of critical assets, nodes, and sensitive materials; counterreconnaissance; and security of designated key personnel).

- Internment and resettlement operations, to include collection, detention and internment, protection, sustainment, and evacuation of EPW and civilian internees, dislocated civilians, and US military prisoners.

- Law and order operations, to include law enforcement, criminal investigations, US military prisoner confinement, and counterterrorism and antiterrorism activities.

- Police intelligence operations, to include activities relative to the collection, integration, and dissemination of police information and intelligence.

- Security aspects of foreign internal defense (FID) operations, in coordination with the G2 (S2).

- Support to civil authorities during domestic disturbances and disasters when authorized and legally permitted, in coordination with the G5 (S5) and the staff judge advocate.

- Coordinates customs and counterdrug activities.
- Provides physical security guidance for commanders, assistance in area damage control, and NBC detection and reporting.
- Performs liaison with local civilian law enforcement authorities.
- Assists the G1 in the administration of discipline, and law and order, including AWOL; desertion; court-martial offenses; requests for transfer of internees, detainees, and prisoners; rewards and punishments; and disposition of stragglers.
- Provides statistical data on AWOL, desertion, and so on, to the G1 through the G3.
- Recommends IR to the G2 through the G3.
- Coordinates with the G4 for all logistics requirements relative to EPW and civilian internees, US military prisoners, and dislocated civilians.
- Coordinates with the finance officer and RM on pay support for EPWs and civilian internees, and on financial aspects of weapons bounty programs.

Psychological Operations (PSYOP) Officer. The psychological operations officer is the special staff officer responsible for coordinating PSYOP assets and operations in the command. A PSYOP officer is located at corps and division levels. If no PSYOP officer is assigned to the command, the PSYOP support element commander of an attached PSYOP support element may assume the duties and responsibilities of the PSYOP

special staff officer. Besides his common staff responsibilities, the PSYOP officer's specific responsibilities are as follows:

- Exercises staff planning and coordination over PSYOP activities.
- Evaluates, with the G2 and G5, enemy PSYOP efforts and the effectiveness of friendly PSYOP on target groups.
- Coordinates with the G5 (S5) for the impact of PSYOP.
- Coordinates audience pretesting and post testing for propaganda and counterpropaganda products.
- Coordinates with the G5 (S5) for the planning of and assistance with the execution of dislocated civilian operations.
- Evaluates the effectiveness of the PSYOP campaign on the target audience.
- Evaluates the psychological impact of military operations on the enemy and the civilian populace.
- Recommends IR to the G2 through the G3.
- Coordinates with the PAO and G5 to ensure informational messages being disseminated are consistent.

Safety Officer. The safety officer is the special staff officer responsible for coordinating safety activities throughout the command. A safety officer is located at every echelon of command from battalion to corps. Besides his common staff responsibilities, the safety officer's specific responsibilities are as follows:

- Develops, supervises, and monitors—
 - Command safety and occupational health program.
 - Risk management program for all operations and activities in the command.
 - Accident prevention program.
- Coordinates the staff risk management for each exercise and makes recommendations to the G3.
- Coordinates with the inspector general and provost marshal on unsafe trends collected during inspections.
- Provides input to the G1 on projected accidental losses.
- Provides safety training to the local civilian labor force.

- Coordinates with the G3 and G4 on safety measures in transportation and storage of arms, ammunition, explosives, petroleum products, and other hazardous material.

- Assists the commander and staff in integrating risk management into the planning, coordinating, and development of plans and orders to protect the force from accidental loss.

- Assists the commander in developing, implementing, and monitoring air and ground programs to prevent accidental loss.

- Collects and analyzes accidental loss data for trend analysis and dissemination leading to the development of risk reduction control measures as well as prevention programs.

- Prepares risk assessments and recommends appropriate risk reduction control measures for all operations.

- Assists the commander's staff, the staff of higher and lower commands, joint forces, and host nations in risk management for their functional areas.

- Assesses unit risk management performance during planning and execution; recommends changes to risk reduction control measures as needed.

Special Operations Coordinator (SOCOORD). The special operations coordinator is the special staff officer responsible for coordinating and integrating Special Forces (SF), Ranger, and Special Operations Aviation assets and activities. A SOCOORD is normally located only on the corps staff. However, whenever a special operations unit is attached or under OPCON of the force, someone either from the staff or the attached unit will perform the duties of a SOCOORD. Below the corps echelon, a unit normally receives a special operations LNO team to perform SOCOORD duties. Besides his common staff responsibilities, the SOCOORD's responsibilities are as follows:

- Advises the commander on SF, Ranger, and Special Operations Aviation capabilities and limitations.

- Provides coordination between the corps and the special operations command and control element (SOCCE) that may be located with the unit's main tactical operations center (TOC).

- Coordinates specific requirements for and conducts liaison with the theater special operations command (SOC), Army special operations task force

(ARSOTF), and the joint special operations task force (JSOTF).

- Coordinates with the conventional force's long-range surveillance units to deconflict operations (routes, air routes, targets for surveillance, and target handover).
- Recommends IR to G2 through the G3.
- Coordinates SF, Ranger, and Special Operations Aviation support requirements with other staff sections.
- Helps plan and coordinate linkup between the corps and Army special operations forces (ARSOF).
- Provides staff expertise to other staff sections on SF, Ranger, and Special Operations Aviation employment, doctrine, tactics, techniques, and procedures.

Theater Airlift Liaison Officer (TALO). The theater airlift liaison officer is the special staff officer responsible for advising the commander on the best use of airlift resources and coordinating the use of airlift resources. The TALO is an AF-rated officer. TALOs are normally located at corps, division, regiment, and separate brigades. Besides his common staff responsibilities, the TALO's specific responsibilities are as follows:

- Advises the ground commander on the capabilities, limitations, and utilization of AF fixed-wing theater and strategic airlift assets.
- Assists the ground commander in planning and coordinating preplanned, immediate, and emergency theater and strategic airlift support of ground operations.
- Operates and maintains airlift advance notification/coordination net.
- Ensures the TALO and any augmenting TALOs are manifested for Army movements in conjunction with exercises or contingencies.
- Performs drop zone surveys, drop zone control, and landing zone safety officer duties when combat control teams or Army drop zone support teams are unavailable.

G4 (S4)

Transportation Officer (TO). The TO is the coordinating staff responsibility of the ACofS, G4 (S4). The TO is the special staff officer responsible for coordinating the transportation assets and operations in the command. There is a transportation officer at corps (CTO) and division (DTO) levels. Besides his common staff

responsibilities, the transportation officer's specific responsibilities are as follows:

- Plans and supervises—
 - Administrative movement, including onward movement from port of debarkation (POD), CSS movements, and other movement as directed by the G3 (S3).
 - Movement scheduling and regulation of MSRs.
 - Mode operations (truck, rail, air, and water).
 - Movement of material and personnel.
- Monitors movements on routes two echelons down.
- Coordinates transportation from higher echelons if requirements exceed available resources.

Personal Staff

Some staffs have personal staff officers who work under the immediate control of the commander and therefore have direct access to the commander. The commander establishes guidelines or gives specific guidance when the personal staff officer should inform, or coordinate with, the chief of staff or other members of the staff on issues.

Most personal staff officers also perform duties as special staff officers, working with a coordinating staff officer. This is done case by case, depending on the guidance of the commander or the nature of the task. Personal staff officers also may work indirectly under the supervision of the XO or CofS.

Listed below are the members who normally make up the commander's personal staff. Either by law or regulation, these staff members have a unique relationship with the commander. Although there are other members in the commander's personal staff, this manual discusses only the staff officers, with the exception of the command sergeant major. Following are the personal staff officers discussed in this section:

- Command sergeant major (CSM).
- Aide-de-camp.
- Chaplain.
- Inspector general (IG).
- Public affairs officer (PAO).
- Staff judge advocate (SJA).

Command Sergeant Major (CSM) (No Coordinating Staff Responsibility)

The command sergeant major is a member of the commander's personal staff by virtue of his being the senior noncommissioned officer of the command. The CSM is responsible for providing the commander with personal, professional, and technical advice on enlisted soldier matters and the noncommissioned officer (NCO) corps as a whole. A command sergeant major is located at every echelon of command from battalion through corps. The CSM's duties and responsibilities vary according to the commander's specific desires and the unit's type, size, and mission. The command sergeant major's normal specific duties are as follows:

- Provides advice and recommendations to the commander and staff in matters pertaining to enlisted personnel.
- Executes established policies and standards concerning enlisted personnel's performance, training, appearance, and conduct.
- Maintains communications with subordinate unit NCOs and other enlisted personnel through NCO channels.
- Monitors unit and enlisted personnel training and makes corrections as necessary.
- Administers and monitors the unit noncommissioned officer development program (NCODP) and sergeant's time training (STT).
- Provides counsel and guidance to NCOs and other enlisted personnel.
- Develops the unit METL with the commander.
- Administers and chairs unit selection and soldier boards for enlisted personnel.
- Performs other duties the commander prescribes, including receiving and orienting newly assigned enlisted personnel and helping inspect command activities and facilities.
- Monitors and recommends actions as necessary on the morale and discipline of the unit.
- Coordinates unit security operations, to include fighting positions and local security.

Aide-De-Camp (No Coordinating Staff Responsibility)

The aide-de-camp serves as a personal assistant to a general officer. An aide-de-camp is authorized for general officers in designated positions. The rank of the

aide-de-camp depends on the rank of the general officer. An aide-de-camp's specific responsibilities are as follows:

- Provides for the general officer's personal well-being and security and relieves him of routine and time-consuming duties.
- Helps prepare and organize schedules, activities, and calendars.
- Prepares and executes trip itineraries.
- Meets and hosts the general officer's visitors at his headquarters or quarters.
- Coordinates protocol activities.
- Acts as an executive assistant.
- Supervises other personal staff members (secretaries, assistant aides, enlisted aides, drivers).
- Performs varied duties, according to the general officer's desires.

Chaplain (Coordinating Staff Responsibility, ACofS, G1 (S1), when required)

The chaplain is a personal staff officer responsible for coordinating the religious assets and operations within the command. The chaplain is a confidential advisor to the commander for religious matters. A chaplain is located at every echelon of command from battalion through corps. Besides his common staff responsibilities, the chaplain's specific responsibilities are as follows:

- Advises the commander on the issues of religion, ethics, and morale (as affected by religion), including the religious needs of all assigned personnel.
- Provides commanders with pastoral care, personal counseling, advice, and the privilege of confidentiality and sacred confidence.
- Develops and implements the commander's religious support program.
- Exercises staff supervision and technical control over religious support throughout the command.
- Provides moral and spiritual leadership to the command and community.
- Coordinates religious support with unit ministry teams of higher and adjacent headquarters, other services, and multinational forces or coalition partners.

- Translates operational plans into battlefield ministry priorities for religious support.
- Helps the commander ensure that all soldiers have the opportunity to exercise their religion.
- Advises the commander and staff, with the G5 (S5), of the impact of the faith and practices of indigenous religious groups in an area of operations.
- Performs or provides religious rites, sacraments, ordinances, services, and pastoral care and counseling to nurture the living, care for casualties, and honor the dead.
- Provides religious support to the command and community to include confined or hospitalized personnel, EPWs, civilian detainees, and refugees.
- Provides liaison to indigenous religious leaders in close coordination with the G5 (S5).
- Trains, equips, and supports the subordinate chaplain and the chaplain assistant.

Inspector General (IG) (Coordinating Staff Responsibility, ACofS, G1/S1, when required)

The inspector general is a personal staff officer responsible for advising the commander on the overall welfare and state of discipline of the command. The IG is a confidential advisor to the commander. An IG is located with general officers in command and with selected installation commanders. Besides his common staff responsibilities, the inspector general's specific responsibilities are as follows:

- Integrates the commander's organizational inspection program.
- Conducts inspections, surveys, and studies as the commander requires and monitors corrective actions.
- Receives allegations and conducts investigations and inquiries.
- Monitors and informs the commander of trends, both positive and negative, in all activities.
- Consults staff sections, as appropriate, to obtain items for the special attention of inspectors and to arrange for technical assistance.
- Determines the command's discipline, efficiency, economy, morale, training, and readiness.
- Assists soldiers, DA civilians, family members, retirees, and other members of the force who seek help with Army-related problems.

- Provides the commander with a continuous, objective, and impartial assessment of the command's operational and administrative effectiveness.

- Identifies and assists in the resolution of systemic issues.

NOTE: The IG serves on the commander's personal staff in accordance with AR 20-1. For additional duties and responsibilities of the IG, see AR 20-1.

Public Affairs Officer (PAO) (Coordinating Staff Responsibility, ACofS, G1 (S1), when required)

The public affairs officer is a personal staff officer responsible for understanding and fulfilling the information needs of soldiers, the Army community, and the public. A public affairs officer is located at corps, division, and major support command levels. Besides his common staff responsibilities, the public affairs officer's specific responsibilities are as follows:

- Plans and supervises a command public affairs program.
- Advises and informs the commander of the public affairs impact and implications of planned or implemented operations.
- Serves as the command's spokesman for all communication with external media.
- Assesses the information requirements and expectation of the Army and the public, monitors the media and public opinion, and evaluates the effectiveness of public affairs plans and operations.
- Facilitates media efforts to cover operations by expediting the flow of complete, accurate, and timely information.
- Coordinates logistics and administrative support of civilian journalists under administrative control of the unit.
- Conducts liaison with media representatives to provide accreditation, mess, billet, transport, and escort as authorized and appropriate.
- Develops, disseminates, educates, and trains the command on policies and procedures for protecting against the release of information detrimental to the mission, national security, and personal privacy.
- Informs soldiers, family members, and DOD civilians of their rights under the *Privacy Act*, their responsibilities for OPSEC, and their roles as implied representatives of the command when interacting with news media.

- Coordinates with G3 (PSYOP) and G5 to ensure information being disseminated is not contradictory.
- Assesses and recommends news, entertainment, and other information needs of soldiers and home station audiences.
- Works closely with the G5 (S5) and other agencies to integrate strategy and unify efforts to communicate the Army's perspective and to support the mission's tactical and operational objectives.
- Advises the commander and staff on *Privacy Act* and *Freedom of Information Act* matters.

NOTE: The PAO serves on the commander's personal staff in accordance with AR 360-5. For additional information on the duties and responsibilities of the PAO, see AR 360-5.

Staff Judge Advocate (SJA) (Coordinating Staff Responsibility, ACofS, G1 (S1), when required)

The staff judge advocate is the commander's personal legal advisor on all matters affecting the morale, good order, and discipline of the command. As a special staff officer, the SJA provides legal support to the members of the command and community. An SJA is located at corps, division, and major support command levels. A legal support element, including at least a judge advocate, deploys in direct support of each brigade-level task force. Besides his common staff responsibilities, the staff judge advocate's specific responsibilities are as follows:

- Provides legal advice to the commander on—
 - Military law (DOD directives, DA regulations, and command regulations).
 - Domestic law (US statutes, federal regulations, and state and local laws).

- Foreign law, status-of-forces agreements, and international law.

- The Law of Armed Conflict (Geneva and Hague Conventions).

- Rules of engagement (ROE).

- Environmental laws and treaties.

- Warfare treaties.

- Treatment of EPWs and civilian internees.

- Provides legal services in administrative law, claims, contract law, criminal law, international law, legal assistance, environmental law, and operational law.

- Supervises the administration of military justice.

- Communicates directly with the commander concerning the administration of military justice.

- Ensures that throughout the command criminal law matters are handled in a manner that ensures the rights of individuals are protected and the interests of justice are served.

- Coordinates with the G4 on the legal aspects of contracting policies, and drafts requisition forms and nonstandard local contracts.

- Coordinates with representatives of the Army trial defense service to provide trial defense counsel to represent soldiers.

- Coordinates with representatives of the Army trial judiciary to provide military judges for general and special courts-martial.

NOTE: The SJA serves on the commander's personal staff in accordance with AR 27-1. For additional information and duties of the SJA, see AR 27-1.

Chapter 5

The Military Decision-Making Process

Decision making is knowing *if* to decide, then *when* and *what* to decide. It includes understanding the consequence of decisions. Decisions are the means by which the commander translates his vision of the end state into action.

Decision making is both science and art. Many aspects of military operations—movement rates, fuel consumption, weapons effects—are quantifiable and, therefore, part of the *science* of war. Other aspects—the impact of leadership, complexity of operations, and uncertainty regarding enemy intentions—belong to the *art* of war.

The military decision-making process (MDMP) is a single, established, and proven analytical process. (See Figure 5-1, page 5-2.) The MDMP is an adaptation of the Army's analytical approach to problem solving. The MDMP is a tool that assists the commander and staff in developing estimates and a plan. While the formal problem-solving process described in this chapter may start with the receipt of a mission, and has as its goal the production of an order, the analytical aspects of the MDMP continue at all levels during operations.

The MDMP helps the commander and his staff examine a battlefield situation and reach logical decisions. The process helps them apply thoroughness, clarity, sound judgment, logic, and professional knowledge to reach a decision. The full MDMP is a detailed, deliberate, sequential, and time-consuming process used when adequate planning time and sufficient staff support are available to thoroughly examine numerous friendly and enemy courses of action (COAs). This typically occurs when developing the commander's estimate and operation plans (OPLANs), when planning for an entirely new mission, during extended operations, and during staff training designed specifically to teach the MDMP.

The MDMP is the foundation on which planning in a time-constrained environment is based. The products created during the full MDMP can and should be used during subsequent planning sessions when time may not be available for a thorough relook, but where existing METT-T factors have not changed substantially. (See page 5-27 for a discussion of decision making in a time-constrained environment.)

The MDMP relies on doctrine, especially the terms and symbols (graphics) found in FM 101-5-1. The use of approved terms and symbols facilitates the rapid and consistent assessment of the situation and creation and implementation of plans and orders by minimizing confusion over the meanings of terms and symbols used in the process.

The *advantages* of using the complete MDMP instead of abbreviating the process are that—

- It analyzes and compares multiple friendly and enemy COAs in an attempt to identify the best possible friendly COA.
- It produces the greatest integration, coordination, and synchronization for an operation and minimizes the risk of overlooking a critical aspect of the operation.
- It results in a detailed operation order or operation plan.

The *disadvantage* of using the complete MDMP is that it is a time-consuming process.

ROLES OF THE COMMANDER AND STAFF

The commander is in charge of the military decision-making process and decides what procedures to use in each situation. The planning process hinges on a clear articulation of his battlefield visualization. He is personally responsible for planning, preparing for, and executing operations. From start to finish, the commander's personal role is central: his participation in the process provides focus and guidance to the staff. However, there are responsibilities and decisions that are the commander's alone (Figure 5-1). The amount of his direct involvement is driven by the time available, his personal preferences, and the experience and accessibility of the staff. The less time available, the less experienced the staff, and the less accessible the staff, generally the greater the commander involvement. Examples for discussion of increased commander involvement are found in Decision Making in a Time-Constrained Environment, page 5-27.

The commander uses the entire staff during the MDMP to explore the full range of probable and likely

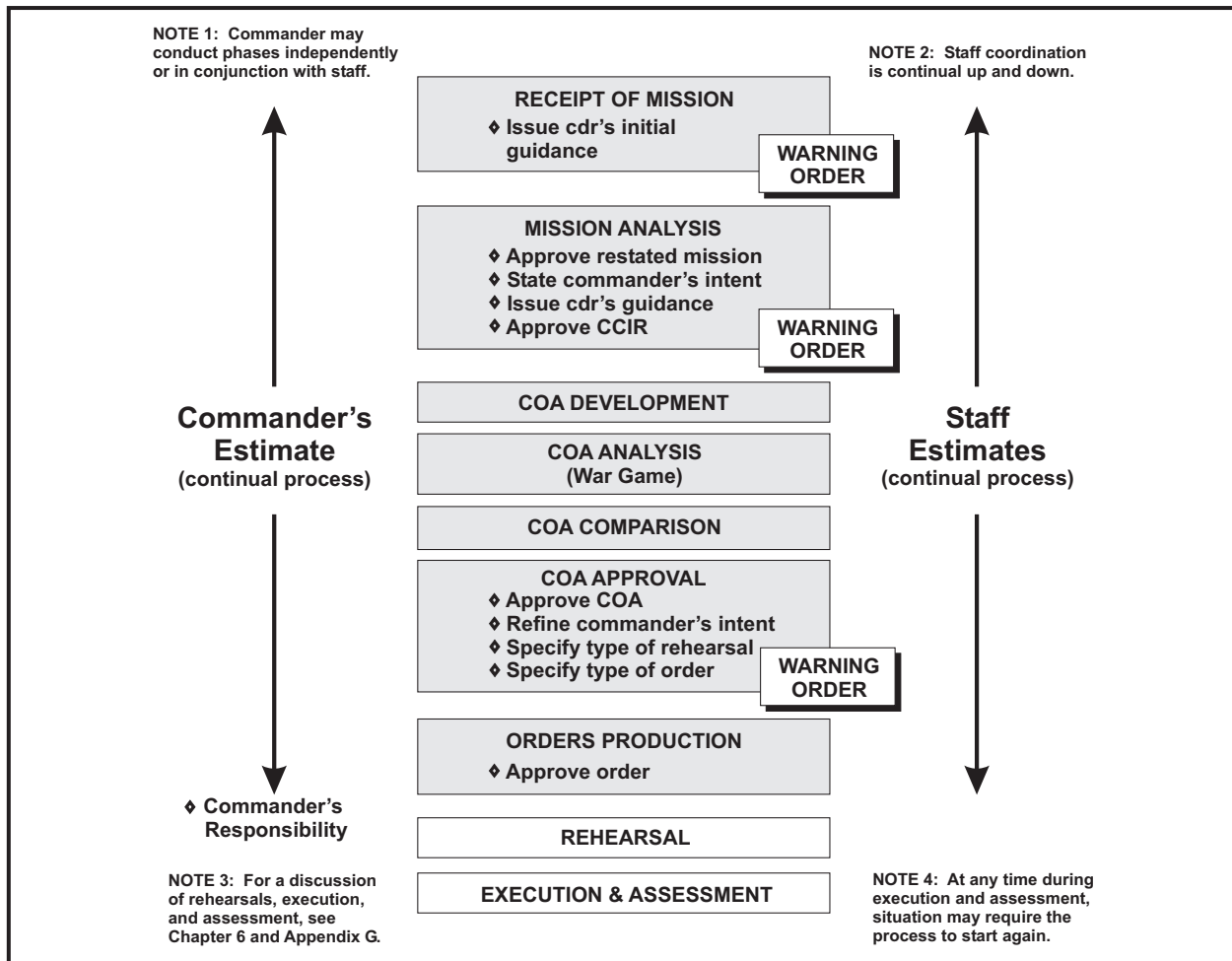

Figure 5-1. The military decision-making process

enemy and friendly COAs, and to analyze and compare his own organization's capabilities with the enemy's. This staff effort has one objective—to collectively integrate information with sound doctrine and technical competence to assist the commander in his decisions, leading ultimately to effective plans.

The CofS (XO) manages, coordinates, and disciplines the staff's work and provides quality control. He must understand the commander's guidance because he supervises the entire process. He ensures the staff has the information, guidance, and facilities it needs. He provides time lines to the staff, establishes briefback times and locations, and provides any unique instructions.

By issuing guidance and participating in formal and informal briefings, the commander and CofS (XO)

guide the staff through the decision-making process. Such interaction helps the staff resolve questions and involves the entire staff in the total process. The selected course of action and its implementing operation order are directly linked to how well both the commander and staff accomplish each phase of the MDMP.

THE ROLE OF RECONNAISSANCE DURING THE PLANNING PROCESS

The commander and staff deploy reconnaissance assets early in the planning process to facilitate early collection. However, reconnaissance assets should not be launched without using, as a minimum, the reconnaissance planning factors found in step 9 of mission analysis (page 5-8). The

commander and staff analyze the information collected and incorporate it into the planning process. They ensure reconnaissance is continuous during the planning of, preparation for, and execution of, the mission. Information collected during reconnaissance may result in initial plans or COAs having to be modified or even discarded. The earlier the need for modifications can be identified, the easier they can be incorporated and synchronized into the plan. Further, when the plan changes, the commander must modify his reconnaissance objective to support the new plan.

An effective leader's or staff reconnaissance can assist significantly in developing COAs. Conducted early in the planning process, it can help confirm or deny the commander's and staff's initial assessments. It may also allow them to immediately focus on a specific COA, or eliminate COAs that the reconnaissance shows to be infeasible. This reconnaissance may be a map reconnaissance or a physical reconnaissance of the terrain.

When conducting a reconnaissance with the staff, the commander must determine if the benefits outweigh the risks. During defensive operations, the reconnaissance can be conducted with little risk. During offensive operations, personal reconnaissance involves more risk and may not be practical. Then the commander and staff may have to rely on the command's reconnaissance assets.

THE MILITARY DECISION-MAKING PROCESS MODEL

The military decision-making process has seven steps (Figure 5-2). Each step of the process begins with certain input that builds upon the previous steps. Each step, in turn, has its own output that drives subsequent

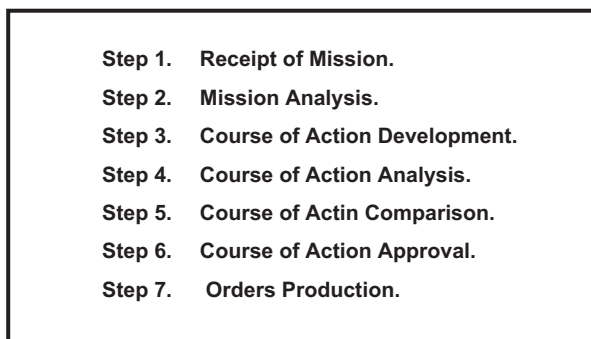

Figure 5-2. The steps in the MDMP

steps. (See Figure 5-3, page 5-4.) Errors committed early in the process will impact on later steps.

Estimates go on continuously to provide important inputs for the MDMP. The commander and each staff section do estimates. (See Appendix C.) Estimates are revised when important new information is received or when the situation changes significantly. They are conducted not only to support the planning process but also during mission execution.

Receipt of Mission

NOTE: References to higher headquarters in this chapter mean the headquarters one echelon up, unless the reference specifically states two echelons up.

The decision-making process begins with the receipt or anticipation of a new mission. This can either come from an order issued by higher headquarters, or derive from an ongoing operation. For example, the commander determines that he has the opportunity to accomplish his higher commander's intent significantly different from the original course of action because of a change in enemy disposition. This may cause him to plan for a significantly different course of action.

As soon as a new mission is received, the unit's operations section issues a warning order to the staff alerting them of the pending planning process. Unit SOPs identify who is to attend, who the alternates are, and where they should assemble. Providing supporting and attached units copies of the unit SOP ensures they will understand what is expected of them during the process.

The staff prepares for the mission analysis immediately on receipt of a warning order by gathering the tools needed to do mission analysis. These include—

- Higher headquarters' order or plan, with graphics. (When possible, each staff officer receives a copy of the order or plan to assist in fully understanding mission requirements.)
- Maps of the area of operations.
- Both own and higher headquarters' SOPs.
- Appropriate FMs (especially FM 101-5-1).
- Any existing staff estimates.

Staff officers should develop a generic list of requirements for particular types of missions to help them prepare for the mission analysis process. See Appendix A for examples.

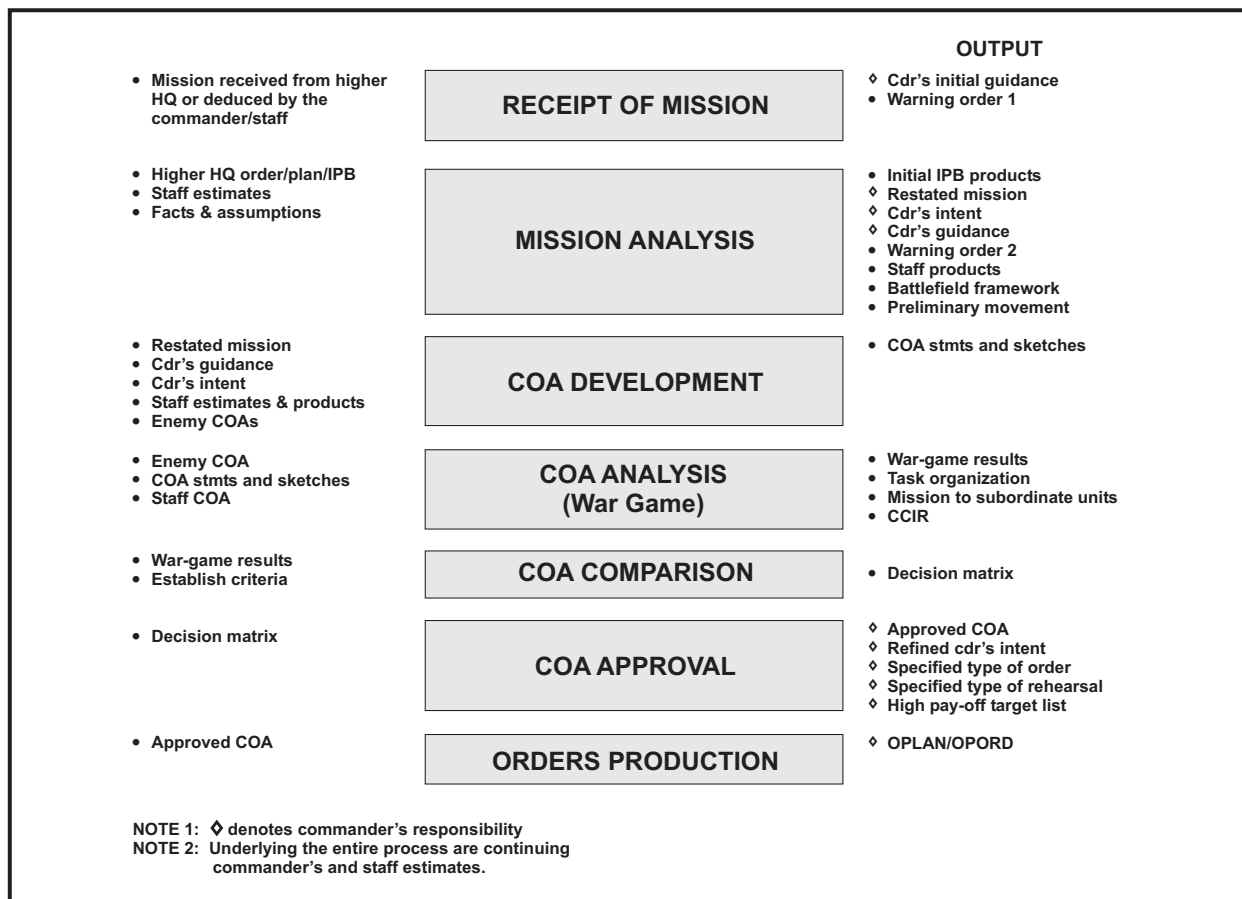

Figure 5-3. Staff inputs and outputs

Staff officers must constantly update their staff estimates and other critical information. This information allows them to develop assumptions that are necessary to the planning process. Staff officers must be aggressive in obtaining this information.

Reporting of this information must be a push system versus a pull system. Subordinate units must rapidly update their reports as the situation changes. Good reporting SOPs must be developed, practiced, and enforced.

Once the new mission is received, the commander and the staff must do a quick initial assessment. It is designed to optimize the commander's use of time while preserving time for subordinate commanders to plan and complete combat preparations. This assessment—

- Determines the time available from mission receipt to mission execution.

- Determines the time needed to plan, prepare for, and execute the mission for own and subordinate units.

- Determines the intelligence preparation of the battlefield (IPB).

- Determines the staff estimates already available to assist planning.

Additional factors to consider are—

- Ambient light requirements for planning, rehearsals, and movement.

- The staff's experience, cohesiveness, and level of rest or stress.

The critical product of this assessment is an initial allocation of available time. The commander and the staff must balance the desire for detailed planning against the need for immediate action. The commander must provide guidance to subordinate units as early as possible to

allow subordinates the maximum time for their own planning and preparation for operations. This, in turn, requires aggressive coordination, deconfliction, integration, and assessment of plans at all levels, both vertically and horizontally.

As a general rule, the commander allocates a minimum of two-thirds of available time for subordinate units to conduct their planning and preparation. This leaves one-third of the time for the commander and his staff to do their *planning*. They use the other two-thirds for their own preparation.

Time, more than any other factor, determines the detail with which the staff can plan. Once time allocation is made, the commander must determine whether or not to do the full MDMP, or to abbreviate the process.

The commander then issues his initial guidance (not to be confused with commander's guidance, Step 15, mission analysis). Although brief, it includes—

- How to abbreviate the MDMP, if required (page 5-27).
- Initial time allocation.
- Liaison officers to dispatch.
- Initial reconnaissance to begin.
- Authorized movement.
- Additional tasks the commander wants the staff to accomplish.

The last step in the mission receipt phase is to issue a warning order to subordinate and supporting units. This order must include as a minimum the type of operation, the general location of the operation, the initial time line, and any movement or reconnaissance to initiate. (See Figure H-6, page H-27.) Warning orders facilitate parallel planning. Parallel planning means that several echelons will be working on their MDMP concurrently. This is essential to speed up the process for subordinate units and allow subordinates the maximum time to conduct their own planning. Parallel planning relies on accurate and timely warning orders and a full sharing of information between echelons as it becomes available. Parallel planning is a routine procedure for the MDMP.

Mission Analysis

Mission analysis is crucial to the MDMP. It allows the commander to begin his battlefield visualization. The result of mission analysis is defining the tactical problem and beginning the process of determining

feasible solutions. It consists of 17 steps, not necessarily sequential, and results in the staff formally briefing the commander. (See Figure 5-4.) In addition to the staff's mission analysis, the commander conducts his own mission analysis so that he has a frame of reference to assess the staff's work. During mission analysis, estimates continue. Anticipation, prior preparation, and a trained staff are the keys to a timely mission analysis.

Step 1. Analyze the Higher Headquarters' Order

The commander and his staff thoroughly analyze the higher headquarters' order to establish horizontal and vertical nesting, not just for maneuver, but also for all combat support and combat service support. This step is to ensure they completely understand—

- The higher headquarters'—
 - Commander's intent.
 - Mission, including tasks, constraints, risk, available assets, and area of operations.
 - Concept of the operation, including the deception plan.

- | | |
|-----------------|--|
| Step 1. | Analyze the higher headquarters' order. |
| Step 2. | Conduct initial intelligence preparation of the battlefield (IPB). |
| Step 3. | Determine specified, implied, and essential tasks. |
| Step 4. | Review available assets. |
| Step 5. | Determine constraints. |
| Step 6. | Identify critical facts and assumptions. |
| Step 7. | Conduct risk assessment. |
| Step 8. | Determine initial commander's critical information requirements (CCIR). |
| Step 9. | Determine the initial reconnaissance annex. |
| Step 10. | Plan use of available time. |
| Step 11. | Write the restated mission. |
| Step 12. | Conduct a mission analysis briefing |
| Step 13. | Approve the restated mission. |
| Step 14. | Develop the initial commander's intent. |
| Step 15. | Issue the commander's guidance. |
| Step 16. | Issue a warning order. |
| Step 17. | Review facts and assumptions. |

Figure 5-4. The steps in the mission analysis

— Time line for mission execution.

- The missions of adjacent (to include front and rear) units and their relation to higher headquarters' plan.
- The assigned area of operations.

Staffs periodically misinterpret the higher headquarters' mission, intent, and guidance, resulting in wasted time. If confused by the higher headquarters' order or guidance, the staff must *seek clarification immediately*. Liaison officers (LNOs) who are familiar with the higher headquarters' plan can assist by attending and participating in the planning process.

Step 2. Conduct Initial Intelligence Preparation of the Battlefield (IPB)

The IPB is a systematic, continuous process of analyzing the threat and the effects of the environment on the unit. It identifies facts and assumptions that determine likely threat COAs. The IPB supports the commander and staff and is essential to estimates and decision making. It provides the basis for intelligence collection and synchronization to support COA development and analysis. It is a dynamic staff process, driven by the commander, that continually integrates new information into the process.

To facilitate parallel planning, the G2 (S2) of the higher headquarters must provide all intelligence products to subordinate units as soon as they are usable, even if only partially complete. The higher headquarters G2 (S2) should have most intelligence products near completion prior to the orders briefing.

The G2 (S2) should not wait until after the orders briefing to release these products. If parallel planning is to occur, and the planning process is to be IPB-driven, this is the only way it can be conducted in a timely fashion. Again, an experienced LNO can contribute significantly by providing warning orders to the unit and passing all intelligence products as soon as they become available.

The IPB is the commander's and each staff officer's responsibility; the G2 (S2) does not do the entire IPB himself. Staff officers must assist the G2 (S2) in developing the situation template (SITTEMP) within their own areas of expertise.

The intelligence preparation of the battlefield—

- Defines the battlefield or operational environment in order to identify the characteristics of the environment that influence friendly and threat operations, to

help determine the area of interest (AI), and to identify gaps in current intelligence.

- Describes the battlefield's effects, including the evaluation of all aspects of the environment with which both sides must contend, to include terrain and weather and any infrastructure and demographics in the area of operations.

- Evaluates the threat by analyzing current intelligence to determine how the threat normally organizes for combat and conducts operations under similar circumstances. This step results in a doctrinal template that depicts how the threat operates when unconstrained by the effects of the environment.

- Using the results of the previous steps, and the effects of the specific environment in which the enemy currently operates, determines the threat's possible COAs and arranges them in probable order of adoption. They are expressed as SITTEMPS, which include all combat multipliers the enemy will use. SITTEMPS must be done prior to the mission analysis briefing; they are used to brief the commander on likely enemy COAs. The G2 (S2) develops and war-games these threat COAs during COA analysis.

The G2 (S2), with staff assistance, continues the IPB, developing event templates from SITTEMPS. The event template is not required for the mission analysis briefing. However, it should be done prior to the staff's COA development as it will help them identify where specific enemy activities may occur.

The results of the initial IPB are the modified combined obstacle overlay and enemy SITTEMPS. Once completed, the products of the IPB are updated and used throughout the operation. The initial IPB should also result in an initial intelligence-collection plan and may result in the launching of available reconnaissance assets to help fill in gaps in the intelligence picture. (However, this follows the process in Step 9 of mission analysis.)

NOTE: See FM 34-130 for detailed information on IPB.

Step 3. Determine Specified, Implied, and Essential Tasks

Specified tasks are those specifically assigned to a unit by its higher headquarters. Paragraphs 2 and 3 of the higher headquarters' order or plan state specified tasks. Specified tasks are also found in annexes and overlays. CS and CSS units may find them in paragraphs 4 and 5 also.

Implied tasks are those that must be performed to accomplish a specified task, but which are not stated in the higher headquarters' order. Implied tasks are derived from a detailed analysis of the higher headquarters' order, the enemy situation and courses of action, and the terrain. Analysis of the unit's current location in relation to its future area of operations provides insights into implied tasks that may be required to perform specified tasks. Additionally, an analysis of the doctrinal requirements for each specified task may provide implied tasks. Only those implied tasks that require allocation of resources should be retained.

Once staff officers have a list of specified and implied tasks, they ensure they understand each task's specific requirements. After analyzing specified and implied tasks, they present to the commander for his approval a tentative list of tasks that *must* be executed to accomplish the mission. These tasks are the *essential tasks*.

Step 4. Review Available Assets

The commander and staff examine additions to and deletions from the current task organization, support relationships, and status (current capabilities and limitations) of all units. They consider the relationship between specified and implied tasks and available assets. From this they determine if they have the assets to perform all specified and implied tasks. If there are shortages, they identify additional resources needed for mission success. The staff needs to pay particular attention to deviations from what the commander considers his normal task organization.

Step 5. Determine Constraints

A higher commander normally places some constraints on his subordinate commanders that restrict their freedom of action. Constraints can take the form of a requirement to do something (for example, maintain a reserve of one company) or a prohibition on action (for example, no reconnaissance forward of a line before H-hour). The commander and his staff must identify and understand these constraints. They are normally found in the scheme of maneuver, the concept of operations, and coordinating instructions.

Step 6. Identify Critical Facts and Assumptions

The staff gathers two categories of information concerning assigned task—facts and assumptions. Facts are statements of known data concerning the situation,

including enemy and friendly dispositions, available troops, unit strengths, and material readiness.

Assumptions are suppositions about the current or future situation that are assumed to be true in the absence of facts. They take the place of necessary, but unavailable, facts and fill the gaps in what the commander and staff know about a situation. An assumption is appropriate if it meets the tests of validity and necessity. Validity means the assumption is likely to be true. "Assuming away" potential problems, such as weather or likely enemy options, would result in an invalid assumption. Necessity is whether or not the assumption is essential for planning. If planning can continue without the assumption, it is not necessary and should be discarded. When possible, assumptions are cleared with the higher headquarters to ensure they are consistent with higher headquarters' plan. Assumptions are replaced with facts as soon as possible.

To determine assumptions, planners should—

- List all appropriate assumptions received from higher headquarters.
- State expected conditions over which the commander has no control but which are relevant to the plan.
- List conditions that would invalidate the plan or its concept of operations.

Step 7. Conduct Risk Assessment

The commander and staff identify accident risk hazards and make an initial assessment of the risk level for each hazard. The commander also makes an initial assessment of where he might take tactical risk. (See Appendix J.)

Step 8. Determine Initial Commander's Critical Information Requirements (CCIR)

The CCIR identify information needed by the commander to support his battlefield visualization and to make critical decisions, especially to determine or validate courses of action. They help the commander filter information available to him by defining what is important to mission accomplishment. They also help focus the efforts of his subordinates and staff, assist in the allocation of resources, and assist staff officers in making recommendations. The CCIR should be limited to 10 or less to enhance comprehension. The CCIR directly affect the success or failure of the mission and they are time-sensitive in that they drive decisions at decision points. The key question is, "What does the commander

need to know in a specific situation to make a particular decision in a timely manner?”

The commander alone decides what information is critical, based on his experience, the mission, the higher commander’s intent, and input from the staff. The staff nominates information requirements (IR) to become CCIR. CCIR are situation-dependent and specified by the commander for each operation. He must continuously review the CCIR during the planning process and adjust them as situations change. During the MDMP, CCIR most often arise from the IPB and war gaming.

The CCIR are normally expressed as priority intelligence requirements (PIR)—information about the enemy; essential elements of friendly information (EEFI)—information needed to protect friendly forces from the enemy’s information-gathering systems; and friendly forces information requirements (FFIR)—information about the capabilities of his or adjacent units.

Step 9. Determine the Initial Reconnaissance Annex

Based on the initial IPB and CCIR, the staff, primarily the G2 (S2), identifies gaps in the intelligence available and determines an initial reconnaissance and surveillance plan to acquire information based on available reconnaissance assets. The G3 (S3) turns this into an initial reconnaissance annex to launch reconnaissance assets as soon as possible to begin their collection effort. This initial reconnaissance annex should contain, as a minimum:

- The area of operations for reconnaissance.
- Mission statement.
- Task organization.
- Reconnaissance objective.
- PIR and IR.
- Line of departure (LD)/line of contact (LC) time.
- Initial named areas of interest (NAIs).
- Routes to AO and passage of lines instructions.
- Communications and logistics support.
- Fire support measures.
- Medical evacuation.

This annex sets reconnaissance in motion. As more information becomes available, it is incorporated into a complete reconnaissance annex to the operation order (OPORD). (See Figure H-22, page H-60.) As these

assets collect information, and other intelligence sources fill in gaps, the taskings to reconnaissance assets must be updated to reflect new CCIR.

Step 10. Plan Use of Available Time

The commander and his staff refine their initial plan for the use of available time. They compare the time needed to accomplish essential tasks to the higher headquarters’ time line to ensure mission accomplishment is possible in the allotted time. They also compare the time line to the enemy time line developed during the IPB. From this they determine windows of opportunity for exploitation or times when the unit will be at risk from enemy activity.

The commander and staff specify when and where they will conduct the briefings that result from the planning process and when, where, and in what form they will conduct rehearsals. The commander can maximize available planning time for his own and subordinate units by sending additional warning orders as detailed planning develops. This allows parallel planning by subordinate units. The commander also uses LNOs to stay abreast of changes at higher headquarters.

Step 11. Write the Restated Mission

The CofS (XO) or G3 (S3) prepares a restated mission for the unit based on the mission analysis. The restated mission must contain all elements of a mission statement:

- Who (what types of forces) will execute the action?
- What type of action (for example, attack, defend) is contemplated?
- When will the action begin?
- Where will the action occur (area of operations and objectives)?
- How will the commander employ available assets?
- Why (for what purpose) will each force conduct its part of the operation?

The element of what states the essential tasks. The restated mission will include on-order missions; be-prepared missions will be in the concept of operations.

Step 12. Conduct a Mission Analysis Briefing

Time permitting, the staff briefs the commander on its mission analysis using the following outline:

- Mission and commander's intent of the headquarters two levels up.
- Mission, commander's intent, concept of the operation, and deception plan or objective of the headquarters one level up.
- Review of commander's initial guidance.
- Initial IPB products.
- Specified, implied, and essential tasks.
- Constraints on the operation.
- Forces available.
- Hazards and their risk.
- Recommended initial CCIR.
- Recommended time lines.
- Recommended restated mission.

The mission analysis briefing should not be a unit readiness briefing. Staff officers must know the status of subordinate and supporting units and brief relevant information as it applies to the situation. The staff should develop standardized charts to monitor and consolidate this type of data to assist the commander in obtaining a quick snapshot of his unit.

The mission analysis briefing is given to both the commander and the staff. This is often the only time the entire staff is present, and the only opportunity to ensure that all staff members are starting from a common reference point. Mission analysis is critical to ensure thorough understanding of the task and subsequent planning.

The briefing focuses on relevant conclusions reached as a result of the mission analysis. This helps the commander and staff develop a shared vision of the requirements for the upcoming operation.

Step 13. Approve the Restated Mission

Immediately after the mission analysis briefing, the commander approves a restated mission. This can be the staff's recommended restated mission, a modified version of the staff's recommendation, or one that the commander has developed himself. Once approved, the restated mission becomes the unit's mission.

Step 14. Develop the Initial Commander's Intent

During the mission analysis, the commander develops his initial intent for the operation. After reviewing the mission analysis briefing and the restated mission, he modifies his intent statement if necessary.

The commander's intent is a clear, concise statement of what the force must do to succeed with respect to the enemy and the terrain and to the desired end state. It provides the link between the mission and the concept of operations by stating the key tasks that, along with the mission, are the basis for subordinates to exercise initiative when unanticipated opportunities arise or when the original concept of operations no longer applies. If the commander wishes to explain a broader purpose beyond that of the mission statement, he may do so. Intent is normally expressed in four or five sentences and is mandatory for all orders. The mission and the commander's intent must be understood two echelons down.

Key tasks are those that must be performed by the force, or conditions that must be met, to achieve the stated purpose of the operation (paragraph 2 of the OPORD or OPLAN). Key tasks are not tied to a specific course of action, rather they identify that which is fundamental to the force's success. In changed circumstances, when significant opportunities present themselves or the course of action no longer applies, subordinates use these tasks to keep their efforts supporting the commander's intent. The operations's tempo, duration, and effect on the enemy, and terrain that must be controlled, are examples of key tasks.

The commander's intent does not include the "method" by which the force will get from its current state to the end state. The method is the concept of operations. Nor does the intent contain "acceptable risk." Risk is stated in the commander's guidance and is addressed in all courses of action. If purpose is addressed in the intent statement, it does not restate the "why" (purpose) of the mission statement. Rather, it is a broader purpose that looks beyond the why of the immediate operation to the broader operational context of the mission.

The commander personally prepares his intent statement. When possible he delivers it, along with the order, personally. Face-to-face delivery ensures mutual understanding of what the issuing commander wants by allowing immediate clarification of specific points.

Commanders from company level up prepare an intent statement for each OPORD or OPLAN. The intent statement at any level must support the intent of the next higher commander. For any OPORD or OPLAN, there is only one commander's intent—that of the commander. Annexes (and their subordinate appendixes, tabs, and enclosures) to the OPORD or OPLAN do not contain an intent statement; they contain a concept of support. For

example, the Fire Support Annex to an OPORD will contain a concept of support, but not an intent statement. However, the OPORD issued to an artillery battalion supporting a maneuver brigade contains the intent statement of the artillery battalion commander.

The intent statement in an OPORD or OPLAN is after the heading for paragraph 3, Operations, and before paragraph 3a, Concept of Operations. The intent statements of the next two higher echelon commanders are contained in paragraph 1b of the OPORD or OPLAN to ensure that the staff and supporting commanders understand the intent two echelons up. At battalion level and higher, the order, containing the intent, is also written. This decreases the chances of misunderstanding.

Step 15. Issue the Commander’s Guidance

After the commander approves the restated mission and states his intent, he provides the staff with enough additional guidance (preliminary decisions) to focus staff activities in planning the operation. This guidance is essential for timely COA development and analysis. By stating the planning options he does or does not want them to consider, he can save staff members time and effort by allowing them to concentrate on developing COAs that meet the commander’s intent. The commander’s guidance may be written or oral.

The commander’s guidance must focus on the essential tasks supporting mission accomplishment. The guidance emphasizes in broad terms when, where, and how he intends to mass his combat power to accomplish the mission according to his higher commander’s intent. Commander’s guidance should include priorities for all combat, CS, and CSS elements and how he envisions their support of his concept. The amount of detail in the guidance depends on the time available, the staff’s level of proficiency, and the flexibility the next higher commander provides. Guidance that is broad and general in nature provides the staff maximum latitude, allowing a proficient staff to develop flexible and effective options. As time becomes more constrained, the commander’s guidance must become more specific and directive. The more detailed the guidance, the more quickly the staff can complete the plan. However, this increases the risk of overlooking or insufficiently examining things that might affect mission execution. See Appendix B for information that can be included in detailed guidance.

If, during the estimate process, the commander has identified one or more decisive points, or an action he considers decisive, he should convey this to the staff. This should be a point where an enemy weakness allows

maximum combat power to be applied, leading to mission accomplishment. This point can be a location on the ground, a time, or an event. It is not an end state, but a point where decisive results can be achieved. The commander can describe it verbally, with a sketch, or on a map. It should explain how he visualizes the array of forces at the decisive point, what effects he sees it having on the enemy, and how these effects will lead to mission accomplishment.

As a minimum, the commander’s guidance should address—

- Specific courses of action to consider or not to consider, both friendly and enemy, and the priority for addressing them.
- The CCIR.
- The reconnaissance guidance.
- Risk guidance.
- Deception guidance.
- Fire support guidance.
- Mobility and countermobility guidance.
- Security measures to be implemented.
- Additional specific priorities for combat support and combat service support.
- Any other information the commander wants the staff to consider.
- The time plan.
- The type of order to issue.
- The type of rehearsal to conduct.

Step 16. Issue a Warning Order

Immediately after the commander gives his guidance, the staff sends subordinate and supporting units a warning order that contains, as a minimum—

- The restated mission.
- The commander’s intent.
- The unit’s AO (a sketch, an overlay, or some other description).
- The CCIR.
- Risk guidance.
- Reconnaissance to be initiated by subordinate units.

- Security measures.
- Deception guidance.
- Mobility and countermobility guidance.
- Specific priorities.
- The time plan.
- Guidance on rehearsals.

Step 17. Review Facts and Assumptions

During the rest of the decision-making process, the commander and staff periodically review all available facts and assumptions. New facts may alter requirements and analysis of the mission. Assumptions may have become facts or may have become invalid. Whenever the facts or assumptions change, the commander and staff must assess the impact of these changes on the plan and make the necessary adjustments.

Course of Action Development

After receiving guidance, the staff develops COAs for analysis and comparison. The commander must involve the entire staff in their development. His guidance and intent focus the staff's creativity to produce a comprehensive, flexible plan within the time constraints. His direct participation helps the staff get quick, accurate answers to questions that occur during the process. COA development is a deliberate attempt to design unpredictable COAs (difficult for the enemy to deduce).

Qualities of COAs

Each COA considered must meet the criteria of—

- **Suitability.** It must accomplish the mission and comply with the commander's guidance. However, the commander may modify his guidance at any time. When the guidance changes, the staff records and coordinates the new guidance and reevaluates each COA to ensure it complies with the change.
- **Feasibility.** The unit must have the capability to accomplish the mission in terms of available time, space, and resources.
- **Acceptability.** The tactical or operational advantage gained by executing the COA must justify the cost in resources, especially casualties. This assessment is largely subjective.
- **Distinguishability.** Each COA must differ *significantly* from any others. Significant differences may result from use of reserves, different task organizations,

day or night operations, or a different scheme of maneuver. This criteria is also largely subjective.

- **Completeness.** It must be a complete mission statement. (See page 5-8.)

A good COA positions the force for future operations and provides flexibility to meet unforeseen events during execution. It also provides the maximum latitude for initiative by subordinates.

The order from higher headquarters normally provides the what, when, and why for the force as a whole. The who in the COA does not specify the designation of units; it arrays units by type (for example, generic armored battalion or mechanized battalion). Designation of specific units comes later.

During COA development, the commander and staff continue the risk management process, focusing on Steps 1 through 3. (See Appendix J.)

Guidelines and Steps to Develop COAs

There are normally six steps in COA development:

1. Analyze relative combat power.
2. Generate options.
3. Array initial forces.
4. Develop the scheme of maneuver.
5. Assign headquarters.
6. Prepare COA statements and sketches.

The following paragraphs describe each step in detail.

Step 1. Analyze Relative Combat Power. Combat power is the effect created by combining the elements of maneuver, firepower, protection, and leadership in combat against the enemy. The commander integrates and applies the effects of these elements with other potential combat multipliers (combat support (CS), combat service support (CSS), and available assets of other services) against the enemy. His goal is to generate overwhelming combat power to accomplish the mission at minimal cost.

By analyzing force ratios and determining and comparing each force's strengths and weaknesses as a function of combat power, planners can gain some insight into—

- What friendly capabilities pertain to the operation.
- What type operations may be possible from both friendly and enemy perspectives.

- How and where the enemy may be vulnerable.
- What additional resources may be required to execute the mission.
- How to allocate existing resources.

Planners initially make a rough estimate of force ratios. At corps and division levels, relative combat power is an evaluation of rough ratios of combat units two levels down. For example, at division level, planners compare all types of combat battalions; at corps level, they compare friendly brigades versus enemy regiments. At brigade and battalion levels, they may study, in detail, the personnel or weapons on either side.

Planners must not develop and recommend COAs based solely on mathematical analyses of force ratios. Although some numerical relationships are used in this process, the estimate is largely subjective. It requires assessing both tangible and intangible factors, such as friction or enemy will and intentions. Numerical force ratios do not include the human factors of warfare that, many times, are more important than the number of tanks or tubes of artillery. The staff must carefully consider and integrate the intangible factors into their comparisons.

Planners can compare friendly strengths against enemy weaknesses, and vice versa, for each element of combat power. From these comparisons, they may deduce particular vulnerabilities for each force that may be exploitable or may need to be protected. These comparisons may provide planners insights into effective force employment.

By using historical minimum-planning ratios for various combat missions and carefully considering terrain and enemy templating assumptions, the planner can generally conclude what types of operations can be conducted successfully. This step provides the planners with what might be possible, not a specific course of action.

NOTE: FM 34-130 contains planning factors and data for estimating force ratios.

Step 2. Generate Options. Based on the commander's guidance and the results of Step 1, the staff generates options for COA development. A good COA should be capable of defeating all feasible enemy COAs. In a totally unconstrained environment, the goal is to develop several such COAs. Since there is rarely enough time to do this, the commander usually limits the options with his commander's guidance. The options should focus on enemy COAs arranged in order of probable adoption.

Brainstorming is the preferred technique for generating options. It requires time, imagination, and creativity, but it produces the widest range of options. The staff must be unbiased and open-minded in evaluating proposed options. Staff members can quickly identify COAs obviously not feasible in their particular areas of expertise. They can also quickly decide if they can modify a COA to accomplish the requirement or eliminate it immediately. If one staff member identifies information that might affect another's analysis, he shares it immediately. This eliminates wasted time and effort.

In developing COAs, staff members must determine the doctrinal requirements for each type of operation they are considering, to include doctrinal tasks to be assigned to subordinate units. For example, a deliberate breach requires a breach force, a support force, and an assault force. In addition, COA development must look at possibilities created by attachments (a light infantry brigade attached to an armored division opens up the possibility of an air assault), options not feasible because of detachments, assets available for deep operations, and assets needed to support deception operations.

The staff first determines the decisive point, if not already determined by the commander. This is where the unit will mass the effects of overwhelming combat power to achieve a result with respect to terrain, enemy, and time that will accomplish the unit's purpose. This will be the main effort. Next, the staff determines supporting efforts—those tasks other than the main effort that must be accomplished to allow the main effort to succeed. The staff then determines the purposes of the main and supporting efforts. The main effort's purpose is directly related to the mission of the unit; the supporting effort's purpose relates directly to the main effort. The staff then determines the essential tasks for the main and supporting efforts to achieve these purposes.

Once staff members have explored each COA's possibilities, they can examine each (changing, adding, or eliminating COAs as appropriate) to determine if it satisfies COA-selection criteria. The staff must avoid the common pitfall of presenting one good COA among several "throwaway" COAs. Often the commander will find he can combine COAs or move desirable elements from one to another.

Step 3. Array Initial Forces. To determine the forces necessary to accomplish the mission and to provide a

basis for the scheme of maneuver, planners must consider—

- The unit's restated mission and the higher commander's intent and guidance.
- The air and ground avenues of approach (both enemy and friendly).
- As many possible enemy COAs as time permits, starting with the most likely and including the worst case (most dangerous).

Planners then determine the ratio of friendly to enemy units required for each task, starting with the main effort and continuing through all supporting efforts. (They consider the entire battlefield framework, including close, deep, rear, reserve, reconnaissance, and security operations.) Such ratios are planning tools for developing COAs only and not for actual combat. (FM 34-130 contains preferred minimum planning ratios to array forces.) Some operations, such as pursuit, exploitation, and movement to contact, require no particular ratio; however, planners can use a ratio of 1:1. This ratio considers terrain and mission but not weather, initiative, surprise, logistics, or intangibles such as leadership, training, and morale. The ratio is a starting point only; planners can adjust the ratio as they develop the COA.

Planners next determine a proposed forward edge of the battle area (FEBA) for a defense or an LD/LC for an offense. The G2's (S2's) initial terrain analysis should validate the selection, or determine a recommended change, which must then be resolved with higher headquarters.

Planners then consider the deception story. Because aspects of the story may influence unit positioning, planners must consider the story's major elements before developing any courses of action.

Planners next make the initial array of friendly forces, starting with the main effort at the decisive point and continuing through supporting efforts. Planners normally array ground forces two levels down. The initial array focuses on generic ground maneuver units without regard to specific type or task organization, and then considers all combat multipliers, as appropriate. For example, at corps level, planners array two levels down using generic brigades consisting of three battalions. During this step, planners do not assign missions to arrayed units; they merely consider what forces they must allocate to accomplish the mission.

The initial array identifies the total number of units needed, develops a base of knowledge to make decisions, and identifies possible methods of dealing with the enemy during scheme-of-maneuver development. If the number arrayed is less than the number available, the additional units are placed in a pool for use during scheme-of-maneuver development. If the number arrayed is greater than the number available, the shortfall is identified as a possible requirement for additional resources.

Step 4. Develop the Scheme of Maneuver. The scheme of maneuver describes how arrayed forces will accomplish the commander's intent. It is the central expression of the commander's concept for operations and governs the design of supporting plans or annexes. Planners develop a scheme of maneuver by refining the initial array of forces and using graphic control measures to coordinate the operation and to show the relationship of friendly forces to one another, the enemy, and the terrain. During this step, units are converted from generic to specific types of units, such as armor, light infantry, and mechanized infantry. The scheme of maneuver includes—

- The purpose of the operation.
- A statement of where the commander will accept tactical risk.
- Identification of critical friendly events and phases of the operation (if phased).
- Designation of the main effort, along with its task and purpose.
- Designation of supporting efforts, along with their tasks and purposes, linked to how they support the main effort.
- Designation of reserve, to include location, composition, task, and purpose.
- Deep, close, and rear operations.
- Reconnaissance and security operations.
- An outline of the movements of the force.
- Identification of maneuver options that may develop during an operation.
- Location of engagement areas or attack objectives and counterattack objectives.
- Responsibilities for area of operations (AO).
- Concept of fires.
- C²-attack priorities.

- Prescribed formations or dispositions when necessary.
- Priorities for each CS and CSS element in support of the operation.
- Integration of obstacle effects with maneuver and fires.
- Considerations of the effects of enemy weapons of mass destruction (WMD) on the force.

Planners select control measures (graphics) to control subordinate units during the operation. Planners base control measures on the array of forces and the scheme of maneuver to defeat probable enemy courses of action. Control measures clarify responsibilities and synchronize combat power at decisive points while minimizing the command's risk of fratricide. All control measures impose some constraints on subordinate commanders. Control measures used should be the minimum required to exercise necessary control over the operation while still allowing as much freedom of action as possible to subordinate commanders.

Control measures should not split avenues of approach or key terrain between two units. Planners should provide space on the flanks of each avenue of approach to allow for maneuver and fires. The area of operations the planner designates as the main effort may be narrower than others to add weight to that AO. Planners should also develop phase lines to implement expected branches and sequels.

When developing the scheme of maneuver, planners should use any forces remaining from the initial array to provide depth to the battle, provide additional reconnaissance or security, or act as a reserve.

Step 5. Assign Headquarters. Planners next assign headquarters to groupings of forces, creating a task organization. This assignment should consider the types of units to be assigned to a headquarters and its span of control. Planners should not exceed the allocated headquarters' span of control. Generally, a headquarters controls at least two subordinate maneuver units, but not more than five. If planners need additional headquarters, they note the shortage and resolve it later. Task organization takes into account the entire battlefield framework. It also accounts for the special command and control (C²) requirements of operations that have special requirements, such as passage of lines, river crossings, or air assaults.

Step 6. Prepare COA Statements and Sketches. The G3 (S3) prepares a COA statement and supporting sketch for each COA developed. The COA statement must clearly portray how the unit will accomplish the mission and explain the scheme of maneuver. It should include the mission and end state and address the battlefield framework. The sketch provides a picture of the maneuver aspects of the COA. Together, the statement and sketch cover who (generic task organization), what (tasks), when, where, how, and why (purpose) for each subordinate unit, and any significant risks and where they occur for the force as a whole. (See example of COA statement and sketch at Figure 5-5.)

As a minimum, the sketch should include the array of generic forces, and control measures such as—

- Planning unit and subordinate unit boundaries that establish the AO.
- Unit movement formations (does not specify formations of subordinate units).
- The FEBA or LD/LC and subsequent phase lines.
- Reconnaissance and security (R&S) graphics.
- Ground and air axes of advance.
- Assembly areas, battle positions, strongpoints, engagement areas, and objectives.
- Obstacle control measures and tactical mission graphics.
- Fire support coordination measures.
- Designation of the main and supporting efforts.
- Location of command posts.
- Enemy known or templated locations.

Planners can enhance the sketch with identifying features (cities, rivers, roads) to help orient users. The sketch may be on any media—what it portrays is more important than its form.

COURSE OF ACTION CRITERIA

- Suitability
- Feasibility
- Acceptability
- Distinguishability
- Completeness

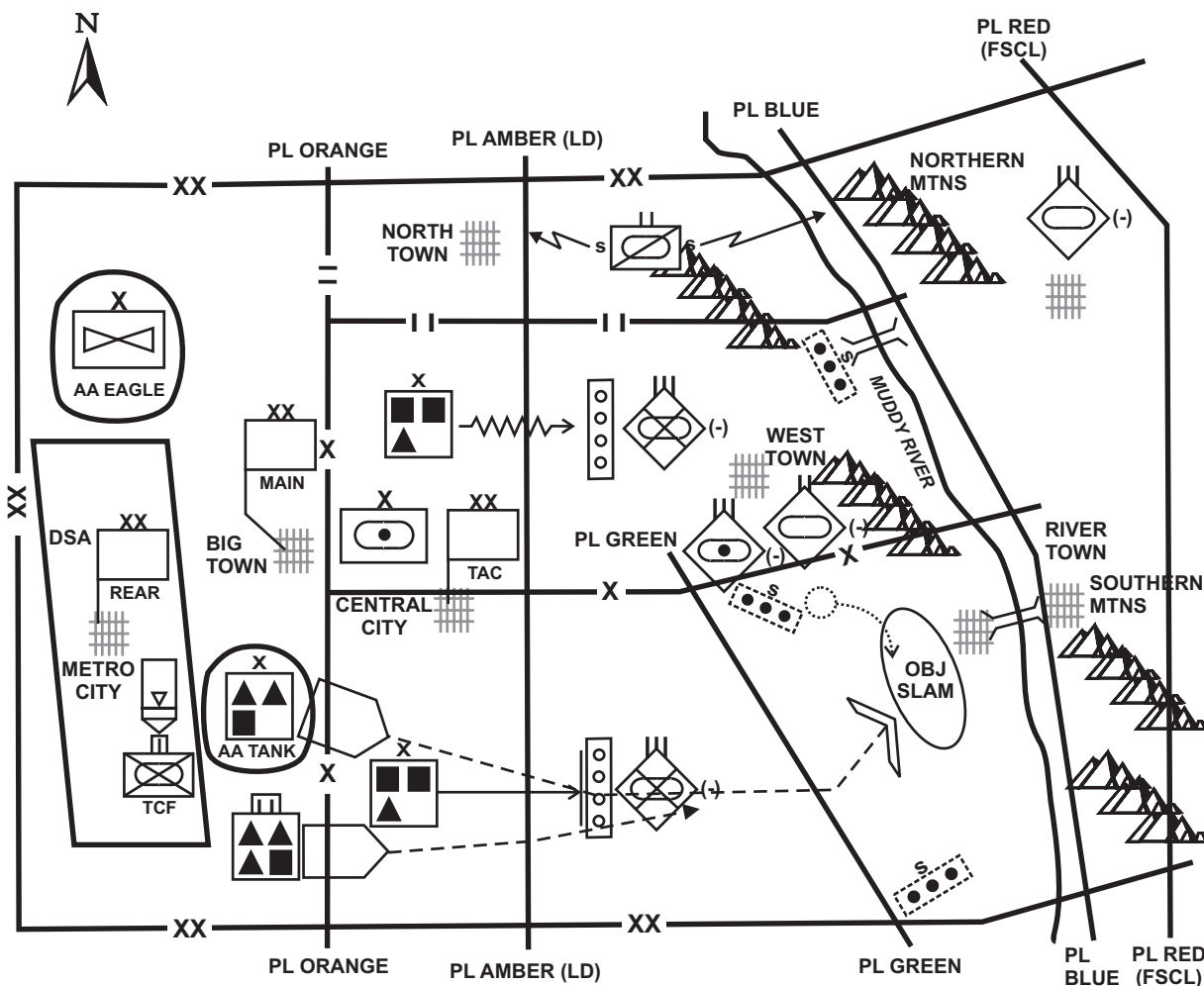

At 130400 Aug XX, a mechanized division attacks to seize OBJ SLAM to protect the northern flank of the corps main effort. A mechanized brigade attacks in the north, as an economy of force, to fix enemy forces in zone denying them the ability to interfere with the main effort's attack in the south. A mechanized brigade in the south attacks to penetrate enemy forces vicinity PL AMBER to create sufficient maneuver space to allow the main effort to pass to the east without interference from the defending enemy infantry regiment (-). A tank-heavy brigade, the main effort, passes through the southern mechanized brigade and attacks to seize the terrain vicinity of OBJ SLAM denying the enemy access to the terrain south and west of RIVER TOWN. The division reserve, a tank task force, initially follows the southern mechanized brigade prepared to contain enemy forces capable of threatening the main effort's passage, then, if not committed west of PL GREEN, follows the main effort prepared to block enemy forces capable of threatening its movement west, ensuring the seizure of OBJ SLAM. The divisional cavalry squadron screens the division's northern flank to provide early warning of any enemy force capable of threatening the division's northern mechanized brigade. Division deep operations will: 1. Initially attrit enemy artillery capable of ranging the point of penetration to prevent it from massing fires against the two southern brigades; 2. then interdict the enemy tank battalion (-) south of WEST TOWN to prevent its movement south and west towards the main effort. 3. Interdict the enemy tank regiment (-) north of EAST TOWN to prevent its movement west of the PL BLUE allowing the main effort sufficient time to seize OBJ SLAM. Division fires will: 1. Isolate the point of penetration allowing the southern mechanized brigade to conduct a penetration. 2. Prevent enemy artillery from massing fires against the two southern brigades. 3. Support deep operations to prevent uncommitted enemy forces from interfering with the initial penetration or the seizure of OBJ SLAM. A mechanized infantry team acts as the division TCF with priority of responding to any Level III threat to the division's Class III supply point vicinity METRO CITY to ensure the uninterrupted flow of Class III.

Figure 5-5. Example of course of action statement and sketch (division offense)

COA Briefing (Optional)

After the COAs have been developed, they are briefed to the commander for review. The COA briefing includes—

- Updated intelligence preparation of the battlefield (IPB).
- Possible enemy COAs (event templates).
- The restated mission.
- The commander's and the higher commanders' intent (two echelons above).
- The COA statement and sketch.
- The rationale for each COA, including—
 - Considerations that might affect enemy COAs.
 - Deductions resulting from a relative combat power analysis.
 - Reason units are arrayed as shown on the sketch.
 - Reason the staff used the selected control measures.
 - Updated facts and assumptions.

After the briefings, the commander gives any additional guidance. If he rejects all COAs, the staff begins again. If he accepts one or more of the COAs, staff members begin the war-gaming process.

Course of Action Analysis (War Game)

The COA analysis identifies which COA accomplishes the mission with minimum casualties while best positioning the force to retain the initiative for future operations. It helps the commander and his staff to—

- Determine how to maximize combat power against the enemy while protecting the friendly forces and minimizing collateral damage.
- Have as near an identical vision of the battle as possible.
- Anticipate battlefield events.
- Determine conditions and resources required for success.
- Determine when and where to apply the force's capabilities.

- Focus IPB on enemy strengths, weaknesses, center of gravity, desired end state, and decisive points.
- Identify the coordination requirements to produce synchronized results.
- Determine the most flexible course of action.

The War-Gaming Process

Course of action analysis is conducted using war gaming. The war game is a disciplined process, with rules and steps, that attempts to visualize the flow of a battle. The process considers friendly dispositions, strengths, and weaknesses; enemy assets and probable COAs; and characteristics of the area of operations. It relies heavily on a doctrinal foundation, tactical judgment, and experience. It focuses the staff's attention on each phase of the operation in a logical sequence. It is an iterative process of action, reaction, and counteraction. War gaming stimulates ideas and provides insights that might not otherwise be discovered. It highlights critical tasks and provides familiarity with tactical possibilities otherwise difficult to achieve. War gaming is the most valuable step during COA analysis and comparison and should be allocated more time than any other step. However, the commander or CofS (XO) must determine at this point how much time he can commit to the war-gaming process, and ensure this time line is followed.

During the war game, the staff takes a COA and begins to develop a detailed plan, while determining the strengths or weaknesses of each COA. War gaming tests a COA or improves a developed COA. The commander and his staff may change an existing COA or develop a new COA after identifying unforeseen critical events, tasks, requirements, or problems.

The General Rules of War Gaming

War gamers need to—

- Remain objective, not allowing personality or their sensing of "what the commander wants" to influence them. They must avoid defending a COA just because they personally developed it.
- Accurately record advantages and disadvantages of each COA as they become evident.
- Continually assess feasibility, acceptability, and suitability of the COA. If a COA fails any of these tests during the war game, they must reject it.
- Avoid drawing premature conclusions and gathering facts to support such conclusions.

- Avoid comparing one COA with another during the war game. This must wait until the comparison phase.

War-Gaming Responsibilities

The CofS (XO) is responsible for coordinating actions of the staff during the war game.

The G1 (S1) analyzes COAs to project potential personnel battle losses and determine how CSS provides personnel support during operations.

The G2 (S2) role-plays the enemy commander. He develops critical enemy decision points in relation to the friendly COA, projects enemy reactions to friendly actions, and projects enemy losses. He captures the results of each enemy action and counteraction and corresponding friendly enemy strengths and vulnerabilities. By trying to win the war game for the enemy, he ensures that the staff fully addresses friendly responses for each enemy COA. For the friendly force, he—

- Identifies information requirements and refines the event template to include NAIs that support decision points and refines the event matrix with corresponding DPs, target areas of interest (TAIs), and high-value targets (HVTs).
- Refines situation templates.
- Participates in the targeting conference and identifies high-value targets as determined by IPB.

The G3 (S3) normally selects the techniques and methods that the staff will use for war gaming. He ensures the war game of the COA covers every operational aspect of the mission, records each event's strengths and weaknesses, and annotates the rationale. This is used later to compare COAs.

The G4 (S4) analyzes each COA to assess its sustainment feasibility. He determines critical requirements for each sustainment function by analyzing each COA to identify potential problems and deficiencies. He assesses the status of all sustainment functions required to support the COA and compares this to available assets. He identifies potential shortfalls and recommends actions to eliminate or reduce their effect for that COA. While improvisation can contribute to responsiveness, only accurate prediction of requirements for each sustainment function can ensure the continuous sustainment of the force. In addition, the G4 (S4) ensures that available movement times and assets will support the course of action.

Special staff officers help the coordinating staff by analyzing the COAs in their own areas of expertise, indicating how they could best support the mission. Every staff member must determine the force requirements for external support, the risks, and each COA's strengths and weaknesses.

War-Gaming Steps

The staff follows eight steps during the war-gaming process:

1. Gather the tools.
2. List all friendly forces.
3. List assumptions.
4. List known critical events and decision points.
5. Determine evaluation criteria.
6. Select the war-game method.
7. Select a method to record and display results.
8. War-game the battle and assess the results.

Step 1. Gather the Tools. The CofS (XO) directs the staff to gather the necessary tools, materials, and data for the war game. Units need to war-game on maps, sand tables, or other tools that accurately reflect the nature of the terrain. The staff then posts the COA on a map displaying the operations area. Tools required include, but are not limited to—

- Current coordinating staff estimates.
- Event template.
- Recording method.
- Completed COAs, to include maneuver and R&S graphics.
- Means to post enemy and friendly unit symbols.
- Map of AO.

Step 2. List all Friendly Forces. The commander and staff consider all available combat, CS, and CSS units that can be committed to the battle, paying special attention to support relationships and constraints. The friendly force list remains constant for all COAs the staff analyzes.

Step 3. List Assumptions. The commander and staff review previous assumptions for continued validity and necessity.

Step 4. List Known Critical Events and Decision Points. Critical events are those that directly influence mission accomplishment. They include events that trigger significant actions or decisions (commitment of an enemy reserve), complicated actions requiring detailed study (a passage of lines), and essential tasks identified during mission analysis. The list of critical events includes major events from the unit's current position to the accomplishment of the mission. Decision points are events or locations on the battlefield where tactical decisions are required during mission execution. Decision points do not dictate what the decision is, only that one must be made, and when and where it should be made, to have the maximum impact on friendly or enemy COAs. Therefore, critical events and decision points must be listed for each enemy COA war-gamed against. Decision points relate to identified critical events and are linked to NAIs and TAIs. The staff must keep the list of critical events and decision points manageable. The more time available for planning, the longer the list. When time is short, the staff must reduce the list to only essential critical events and decision points.

Step 5. Determine Evaluation Criteria. Evaluation criteria are those factors the staff uses to measure the relative effectiveness and efficiency of one COA relative to other COAs following the war game. Evaluation criteria change from mission to mission. Evaluation criteria may include anything the commander desires. Examples include—

- The principles of war.
- Doctrinal fundamentals for the kind of operations being conducted.
- The commander's guidance and intent.
- The level of residual risk for accident hazards in the course of action.

The criteria should look not only at what will create success, but also at what will cause failure.

Step 6. Select the War-Game Method. There are three recommended techniques—the belt, the avenue-in-depth, and the box. Each one considers the area of interest and all enemy forces affecting the outcome of the operations. The techniques can be used separately or in combination, or the staff can devise one of its own.

The *belt technique* divides the battlefield into belts (areas) running the width of the AO (Figure 5-6). The shape of the belt is based on battlefield analysis. The belt

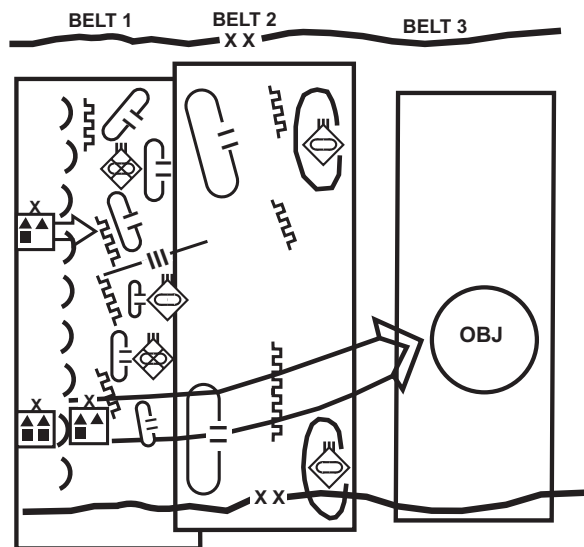

Figure 5-6. Belt war-gaming technique

technique is most effective when terrain is divided into well-defined cross-compartments; during phased operations (such as river crossing, air assault, or airborne operations), or when the enemy is deployed in clearly defined belts or echelons. Belts can be adjacent to or even overlap each other. At a minimum, belts should include the area of—

- Initial contact either along the FLOT or LD/LC, or in the covering force area (CFA).
- Initial penetration or initial contact along the FEBA.
- Passage of the reserve or commitment of a counterattack.
- The objective (offense) or defeat of the enemy (defense).

This technique is based on sequential analysis of events in each belt. It is preferred because it focuses simultaneously on all forces affecting a particular event. A belt might include more than one critical event.

When time is short, the commander can use a modified belt technique. The modified technique divides the battlefield into not more than three sequential belts. These belts are not necessarily adjacent or overlapping, but focus on the critical actions throughout the depth of the area of operations.

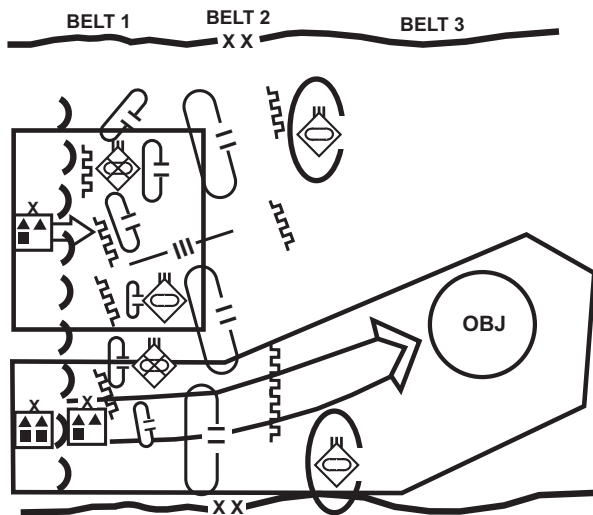

Figure 5-7. Avenue-in-depth war-gaming technique

The *avenue-in-depth technique* focuses on one avenue of approach at a time, beginning with the main effort (Figure 5-7). This technique is good for offensive COAs or in the defense when canalizing terrain inhibits mutual support.

The *box technique* is a detailed analysis of a critical area, such as an engagement area (EA), a river-crossing site, or a landing zone (LZ). (See Figure 5-8.) It is most useful when time is limited, as in a hasty attack. When using this technique, the staff isolates the area and focuses on critical events in it. Staff members assume that friendly units can handle most of the situations on the battlefield and focus their attention on essential tasks.

Step 7. Select a Method to Record and Display Results. Recording the war game's results gives the staff a record from which to build task organizations, synchronize activity, develop decision support templates (DSTs), confirm and refine event templates, prepare plans or orders, and analyze COAs based on identified strengths and weaknesses. Two methods are used to portray the action—the synchronization matrix (Figure 5-9, page 5-20) and the sketch note. In both, staff members record any remarks regarding the strengths and weaknesses they discover. The amount of detail depends on the time available. Details and methods of recording and displaying war-game results are best addressed in unit SOPs.

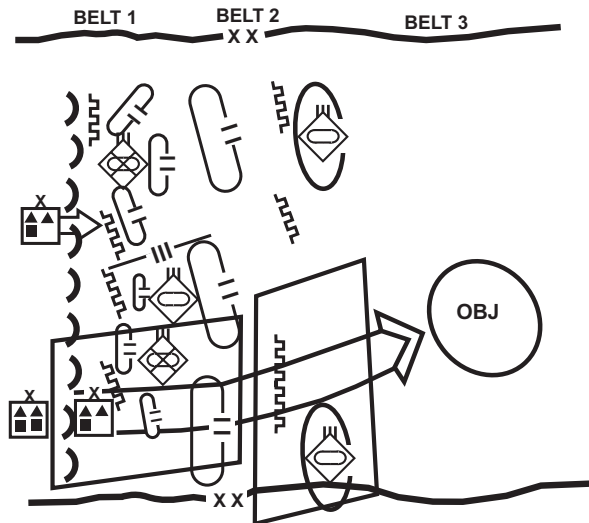
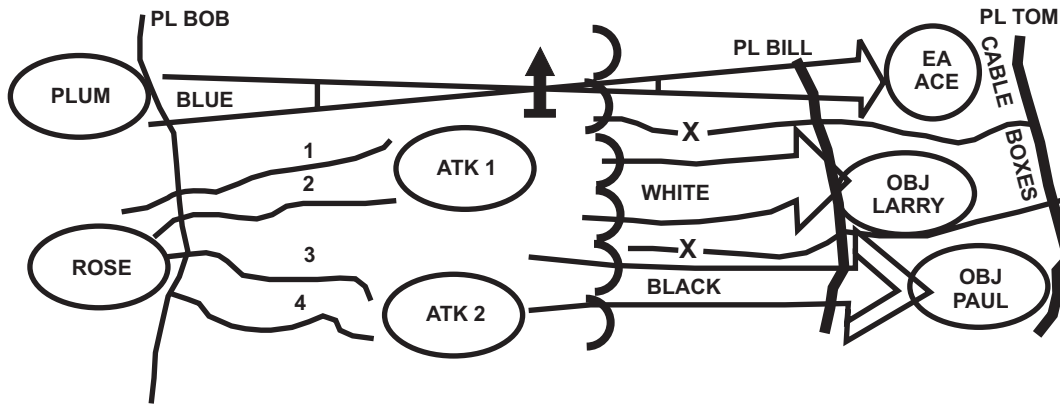

Figure 5-8. Box war-gaming technique

The *synchronization matrix method* allows the staff to synchronize the COA across time and space in relation to the enemy COA. An advantage of this method is that it can be readily translated into a graphic decision-making product, such as a decision support template, at the war game's conclusion. The first entry is time or phases of the operation. The second entry is the most likely enemy action as determined by the G2 (S2). The third entry is the decision points for the friendly COA. The remainder of the matrix is developed around selected functional areas or the major subordinate commands of the unit conducting the war game. Other operations, functions, and units that are to be integrated, or the use of which the staff wants to highlight, can be incorporated into the matrix.

However, the passage of time between the creation of the synchronization matrix and the execution of operations may result in changes to the initial conditions with respect to the enemy, status of friendly forces, and even weather. Once execution begins, the predictability of enemy actions at any point on the synchronization matrix decreases the further away those actions are on the time line. This decreases the likelihood that the synchronization matrix will be correct and increases the likelihood that adjustment to the plan will have to be made.



TIME		-18hr	-14hr	-12hr
ENEMY ACTION			Enemy monitors movements Continue deep preparation	
DECISION POINTS		Initiate movement AA ROSE		
M A N E U V E R	DEEP			
	SECURITY	Recon secures routes		Cav prepares to screen north flank
	CLOSE			1 Bde moves on routes 1 & 2
	RESERVE			3 Bde moves on routes 1 & 2
	REAR			
AIR DEFENSE		Weapons HOLD		Weapons TIGHT
FIRE SUPPORT				
IEW		Confirm second belt and RAG position		Confirm reserve position
ENGINEER		Route maintenance		
C S S	MAN		Replacements held at division	
	ARM			
	FIX	Cannibalization authorized at DS level		Establish div main CP
	FUEL			
	MOVE	Initiate movement from AA ROSE		
	SUSTAIN			
C ²				TAC CP with lead bde

NOTE: The first column is representative only and can be modified to fit individual needs such as including information operations.

Figure 5-9. Example of synchronization matrix

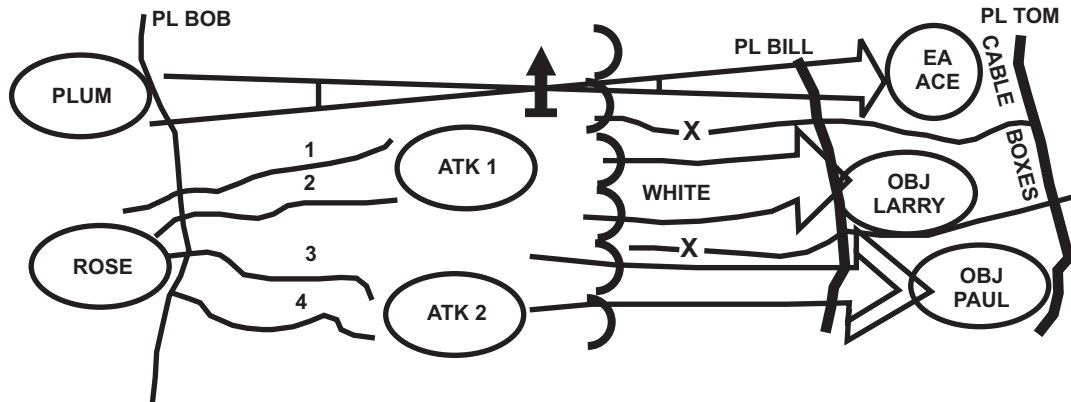

- 8hr	H-hr	+ 6hr	+ 10 hr
		Fights from first belt position	Defend from second belt position
	Launch deep attack		
		Avn bde attacks reserve in EA ACE	
	Cav screen north flank		
2 Bde moves on routes 3 & 4	Bdes cross LD/LC		1 Bde seizes OBJ LARRY
Protect lead bde	Weapons FREE	Weapons TIGHT	
	Provide DS/GS	Fire SEAD	
Conduct nonlethal fires		Confirm reserve movement	
		Prepare forward log sites	
			Establish forward cl V point
Refuel bdes			Establish forward cl III point
		Move stocks forward	
Establish AXP M1		Establish AXP M2	Finance service reinstated
	Div rear boundary moves east of PL BOB		Main CP prepares to move

Figure 5-9. Example of synchronization matrix (continued)

CRITICAL EVENT									
Sequence Number	Action	Reaction	Counter-action	Assets	Time	Decision Point	CCIR	Control Measures	Remarks

Figure 5-10. War-game work sheet

The *sketch note method* uses brief notes concerning critical locations or tasks. These notes reference specific locations on the map or relate to general considerations covering broad areas. The commander and staff note locations on the map and on a separate war-game work sheet (Figure 5-10). Staff members use sequence numbers to reference the notes to the corresponding locations on the map or overlay, using the same numbers on the war-game work sheet for easy reference. Staff members also identify actions by grouping them into sequential action groups, giving each subtask a separate number. They use the war-game work sheet to identify all pertinent data for a critical event. They assign the event a number and a title and use the columns on the work sheet to identify and list in sequence—

- Tasks and assets (allocated forces).
- Expected enemy actions and reactions.
- Friendly counteractions and assets.
- Total assets needed for the task.
- Estimated time to accomplish the task.
- Decision points when the commander must decide to execute the task.
- CCIR.
- Control measures.

Step 8. War-Game the Battle and Assess the Results. During war gaming, the commander and staff try to foresee the dynamics of a battle’s action, reaction, and

counteraction. The staff analyzes each selected event by identifying the tasks the force must accomplish one echelon down, using assets two echelons down. Identifying the COAs’ strengths and weaknesses allows the staff to make adjustments as necessary.

The war game follows an action-reaction-counteraction cycle. *Actions* are those events initiated by the side with the initiative (normally the force on the offensive). *Reactions* are the other side’s actions in response. *Counteractions* are the first side’s responses to reactions. This sequence of action-reaction-counteraction is continued until the critical event is completed or until the commander determines that he must use some other COA to accomplish the mission.

The staff considers all possible forces, including templated enemy forces outside the AO, that could conduct a counterattack. The staff evaluates each friendly move to determine the assets and actions required to defeat the enemy at each turn. The staff should continually evaluate the need for branches to the plan that promote success against likely enemy moves in response to the friendly COA.

The staff lists assets used in the appropriate columns of the worksheet and lists the totals in the assets column (not considering any assets lower than two command levels down).

The commander and staff look at many areas in detail during the war game, including movement considerations, closure rates, lengths of columns, depths of formations, ranges and capabilities of weapons systems, and

desired effects of fires. They look at setting the conditions for success, protecting the force, and shaping the battlefield. Experience, historical data, SOPs, and doctrinal literature provide much of the necessary information. During the war game, staff officers conduct risk management for each COA (Appendix J).

The staff continually assesses the risk to friendly forces from weapons of mass destruction strikes, seeking a balance between mass and dispersion. When assessing WMD risk to friendly forces, the planners view the target the force presents through the eyes of an enemy target analyst. They must consider ways to reduce vulnerability and determine the mission-oriented protective posture (MOPP) level needed for protection consistent with mission accomplishment. They must also consider deployment of nuclear, biological, and chemical (NBC) decontamination units.

The staff identifies the CS and CSS assets required to support the scheme of maneuver and the synchronization of the support and sustainment effort. If requirements exceed available assets, the staff recommends to the commander the priority for use based on the commander's guidance and intent and on the situation. To maintain flexibility, the commander may decide to hold back some assets for unforeseen tasks or opportunities. He uses this analysis to determine his priorities of support.

During the war game, the commander can modify the COA based on how things develop. When modifying the course of action, the commander should validate the composition and location of main and supporting efforts and reserve forces, based on METT-T, and adjust control measures as necessary. The commander may also identify combat situations or opportunities or additional critical events that require more analysis. This should be conducted expeditiously and incorporated into the final results of the war game.

The war game should result in the commander and staff—

- Refining or modifying the COA, to include identifying branches and sequels that become on-order or be-prepared missions.
- Refining location and timing of the decisive point.
- Identifying key or decisive terrain and determining how to use it.
- Refining the enemy event template and matrix.

- Refining task organization, to include forces retained in general support (GS) of the command.
- Identifying tasks the unit must retain and tasks to be assigned to subordinate commanders.
- Allocating combat, CS, and CSS assets to subordinate commanders to accomplish their missions.
- Developing a synchronization matrix and decision support template.
- Estimating the duration of each critical event as well as of the entire operation.
- Projecting the percentage of total enemy forces defeated in each critical event, and overall.
- Identifying likely times and areas for enemy use of WMD and friendly NBC defense requirements.
- Identifying the location and commitment of the reserve.
- Identifying the most dangerous enemy COA.
- Identifying the location of the commander and unit command posts (CPs).
- Identifying additional critical events.
- Identifying additional requirements for CS and CSS support.
- Determining requirements for deception and surprise.
- Refining C² requirements, to include control measures and updated operational graphics.
- Finalizing CCIR and IR with the last time information is of value (LTIOV).
- Finalizing the reconnaissance and surveillance plan and graphics for the basis for the collection plan.
- Refining CCIR and incorporating them into the reconnaissance and surveillance plan and graphics.
- Developing fire support, engineer, air defense, information operations (IO), and CSS plans and graphics.
- Identifying or confirming the locations of decision points, NAIs, and TAIs, and the information needed to support the decision points.
- Determining the timing of force concentration and initiation of the attack or counterattack.

- Developing the intelligence collection and dissemination plan.
- Determining movement times and tables.
- Identifying, analyzing, and evaluating strengths and weaknesses of the COA.
- Integrating the targeting process, to include identifying or confirming high-payoff targets and determining attack guidance.
- Synchronizing smoke operations.
- Identifying additional hazards, assessing their risk, developing control measures to reduce risk from all identified hazards, and determining residual risk.

War-Game Briefing (Optional)

Time permitting, a war-game briefing is conducted to ensure the staff comprehends fully the results of the war game. This briefing is not given to the commander, but is the staff's means to review the war games to ensure that the decision briefing to the commander covers all relevant points. It is normally given to the CofS (XO) or the deputy or assistant commander. The format is—

- Higher headquarters' mission, commander's intent, and deception plan.
- Updated IPB.
- Enemy COAs that were war-gamed.
- Friendly COAs that were war-gamed.
- Assumptions.
- War-gaming technique used.
- For each COA war-gamed—
 - Critical events that were war-gamed.
 - Possible enemy actions and reactions.
 - Modifications to the COA.
 - Strengths and weaknesses.
 - Results of the war game.

Course of Action Comparison

The COA comparison starts with each staff officer analyzing and evaluating the advantages and disadvantages of each COA from his perspective. Each staff member presents his findings for the others' consideration. Using the evaluation criteria developed earlier, the

staff then outlines each COA, highlighting its advantages and disadvantages. Comparing the strengths and weaknesses of the COAs identifies their advantages and disadvantages with respect to each other.

The staff compares feasible courses of action to identify the one that has the highest probability of success against the most likely enemy COA and the most dangerous enemy COA. The selected COA should also—

- Pose the minimum risk to soldiers, equipment, and mission accomplishment.
- Best position the force for future operations.
- Provide the best flexibility to meet “unknowns” during execution.
- Provide maximum latitude for initiative by subordinates.

The actual comparison of COAs is critical. The staff may use any technique that facilitates the staff reaching the best recommendation and the commander making the best decision. The most common technique is the decision matrix, which uses evaluation criteria to assess the effectiveness and efficiency of each COA. (See Figure 5-11, and Figure 5-12, page 5-26.) Each staff officer may use his own matrix, using the same evaluative criteria, for comparison in his own field of interest. Decision matrixes alone cannot provide decision solutions. Their greatest value is to provide analysts a method to compare several competing COAs against criteria which, when met, will produce battlefield success. The matrix should use the evaluation criteria developed earlier. The CofS (XO) normally determines the weight of each criterion based on its relative importance. The staff officer responsible for a functional area scores each COA using that criteria. Multiplying the score by the weight yields the criterion's value. The staff officer then totals all values. However, he must be cautious in portraying subjective conclusions as being the objective results of quantifiable analysis. Comparing COAs by category is more accurate than attempting to aggregate a total score for each COA.

Commander's Decision Briefing

After completing its analysis and comparison, the staff identifies its preferred COA and makes a recommendation. If the staff cannot reach a decision, the CofS (XO) decides which COA to recommend at the

CRITERIA (note 1)	WT (note 2)	COA 1 (note 3)	COA 2 (note 3)	COA 3 (note 3)
Maneuver	3	2 (6)	3 (9)	1 (3)
Simplicity	3	3 (9)	1 (3)	2 (6)
Fires	4	2 (8)	1 (4)	3 (12)
Intelligence	1	3 (3)	2 (2)	1 (1)
ADA	1	1 (1)	3 (3)	2 (2)
Mobility/ Survivability	1	3 (3)	2 (2)	1 (1)
CSS	1	2 (2)	1 (1)	3 (3)
C ²	1	1 (1)	2 (2)	3 (3)
Residual Risk	2	1 (2)	2 (4)	3 (6)
C ² W	1	2 (2)	1 (1)	3 (3)
TOTAL Weighted TOTAL		20 (37)	18 (31)	22 (40)

NOTES:

1. Criteria are those assigned in Step 5 of the war-gaming process.
2. Should the CofS/XO desire to emphasize one as more important than another, he assigns weights to each criterion based on relative importance.
3. Courses of action are those selected for war gaming.

Procedure: The staff assigns numerical values for each criterion after war-gaming the COA. Values reflect the relative advantages or disadvantages of each criterion for each COA action. The lowest number is best. The initially assigned score in each column is multiplied by the weight and the product put in parenthesis in the column. When using weighted value, the lower value assigned indicates the best option. The numbers are totaled to provide a subjective evaluation of the best COA without weighing one criterion over another. The scores are then totaled to provide "best" (lowest number value) COA based on weights the commander assigns. Although the lowest value denotes the best solution, the best solution may be more subjective than the objective numbers indicate. The matrix must be examined for sensitivity. Although COA 2 is the "best" COA, it may not be supportable from a CSS standpoint. The decision maker must either determine if he can acquire additional support or if he must alter or delete the COA.

Figure 5-11. Sample decision matrix: numerical analysis

commander's decision briefing. The staff then briefs the commander. The decision-briefing format includes—

- The intent of the higher headquarters (higher and next higher commanders).
- The restated mission.
- The status of own forces.
- An updated IPB.

- Own COAs, including—
 - Assumptions used in planning.
 - Results of staff estimates.
 - Advantages and disadvantages (including risk) of each COA (with decision matrix or table showing COA comparison).
- The recommended COA.

Course of Action	Advantages	Disadvantages
COA 1	Main attack avoids major terrain obstacles. Adequate maneuver room for main attack and reserve.	Main attack faces stronger resistance at beginning.
COA 2	Main attack gains good observation early. Supporting attack provides flank protection to main attack.	Initially, reserve may have to be employed in zone of supporting attack. Needs detailed and rehearsed procedural and positive controls.

DECISION MATRIX

DISCUSSION:

Factors	Course of Action	
	1	2
Casualty estimate	+	-
Medical evacuation routes	-	+
Suitable location for medical facilities	0	0
Available EPW facilities	-	+
Suitable CP locations	-	+
Courier and distribution routes	-	+
Effects of attachments and detachments on force cohesion, casualty reporting, and replacement operations	-	+
Residual Risk	+	-

BROAD CATEGORIES

NOTE: The factors in the above example are neither all-inclusive nor always applicable.

Figure 5-12. Sample decision matrix: subjective analysis and broad categories

Course of Action Approval

After the decision briefing, the commander decides on the COA he believes to be the most advantageous. If he rejects all developed COAs, the staff will have to start the process over again. If the commander modifies a proposed COA or gives the staff an entirely different one, the staff must war-game the revised or new one to derive the products that result from the war-game process. Once the commander has selected a COA, he may refine his intent statement and CCIR to support the selected COA. He then issues any additional guidance on priorities for CS or CSS activities (particularly for resources he needs to preserve his freedom of action and to ensure continuous service support), orders preparation, rehearsal, and preparation for mission execution.

Having already identified the risks associated with the selected COA, the commander decides what level of residual risk he will accept to accomplish the mission and approves control measures that will reduce the risks. If there is time, he discusses the acceptable risks with

adjacent and senior commanders. However, he must obtain the higher commanders’ approval to accept any risk that might imperil the higher commanders’ intent.

Based on the commander’s decision, the staff immediately issues a warning order with essential information so that subordinate units can refine their plans.

Orders Production

Based on the commander’s decision and final guidance, the staff refines the COA and completes the plan and prepares to issue the order. The staff prepares the order or plan to implement the selected COA by turning it into a clear, concise concept of operations, a scheme of maneuver, and the required fire support. The commander can use the COA statement as his concept of operations statement. The COA sketch can become the basis for the operation overlay. Orders and plans provide all necessary information subordinates require for execution, but without unnecessary constraints that would inhibit subordinate initiative. The staff assists

subordinate staffs as needed with their planning and coordination.

The concept of operations is the commander's clear, concise statement of where, when, and how he intends to concentrate combat power to accomplish the mission in accordance with his higher commander's intent. It broadly outlines considerations necessary for developing a scheme of maneuver. It includes actions within the battlefield organization, designation of the main effort, the commander's plan to defeat the enemy, and specific command and support relationships. These relationships are then included in the task organization and organization for combat in plans and orders.

During orders production, the staff implements accident risk controls by coordinating and integrating them into the appropriate paragraphs and graphics of the OPOD. It is essential to communicate how controls will be put into effect, who will implement them, and how they fit into the overall operation.

Finally, the commander reviews and approves orders before the staff reproduces and briefs them. The commander and staff should conduct confirmation briefings with subordinates immediately following order issue to ensure subordinates understand the commander's intent and concept.

DECISION MAKING IN A TIME-CONSTRAINED ENVIRONMENT

The focus of any planning process should be to quickly develop a flexible, tactically sound, and fully integrated and synchronized plan that increases the likelihood of mission success with the fewest casualties possible. However, any operation may "outrun" the initial plan. The most detailed estimates cannot anticipate every possible branch or sequel, enemy action, unexpected opportunities, or changes in mission directed from higher headquarters. Fleeting opportunities or unexpected enemy actions may require a quick decision to implement a new or modified plan.

Before a unit can conduct decision making in a time-constrained environment, it must master the steps in the full MDMP. A unit can only shorten the process if it fully understands the role of each and every step of the process and the requirements to produce the necessary products. Training on these steps must be thorough and result in a series of staff battle drills that can be tailored

to the time available. Training on the MDMP must be stressful and replicate realistic conditions and time lines. (See Appendix K.)

Although the task is difficult, all staffs must be able to produce a simple, flexible, tactically sound plan in a time-constrained environment. METT-T factors, but especially limited time, may make it difficult to follow the entire MDMP. An inflexible process used in all situations will not work. The MDMP is a sound and proven process that must be modified with slightly different techniques to be effective when time is limited. There is still only one process, however, and omitting steps of the MDMP is not the solution. *Anticipation, organization, and prior preparation* are the keys to success in a time-constrained environment. Throughout the remainder of the chapter, reference to a process that is abbreviated is for simplicity only. It does not mean a separate process, but the same process shortened.

The commander decides how to shorten the process. What follows are suggested techniques and procedures that will save time. They are not exhaustive or the only ways to save time, but they have proved useful to units in the past. These techniques are not necessarily sequential in nature, nor are all of them useful in all situations. What works for a unit depends on its training and the factors of METT-T in a given situation. The commander can use these, or techniques of his own choosing, to abbreviate the process. (See Figure 5-13, page 5-28.)

General Considerations

The process is abbreviated any time there is too little time for its thorough and comprehensive application. The most significant factor to consider is time. It is the only nonrenewable, and often the most critical, resource.

There are four primary techniques to save time. The first is to increase the commander's involvement, allowing him to make decisions during the process without waiting for detailed briefings after each step.

The second technique is for the commander to become more directive in his guidance, limiting options. This saves the staff time by focusing members on those things the commander feels are most important.

The third technique, and the one that saves the most time, is for the commander to limit the number of COAs developed and war-gamed. In extreme cases, he can direct that only one course of action be developed. The

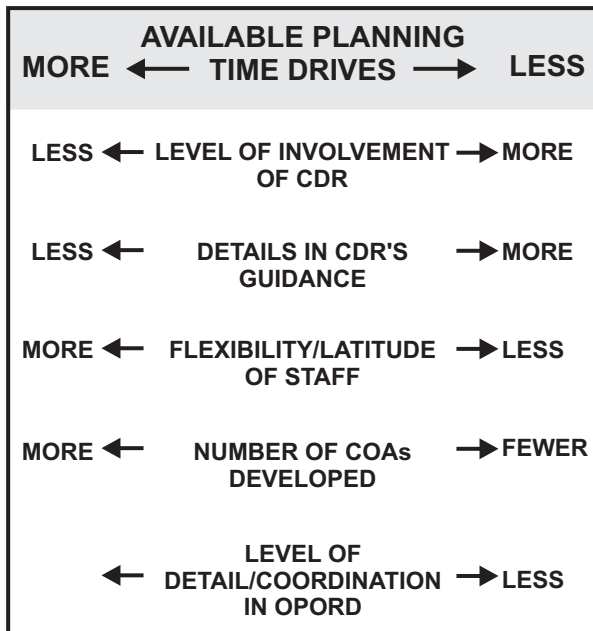

Figure 5-13. Planning continuum

goal is an acceptable COA that meets mission requirements in the time available, even if it is not optimal.

The fourth technique is maximizing parallel planning. Although parallel planning is the norm, maximizing its use in a time-constrained environment is critical. In a time-constrained environment, the importance of warning orders increases as available time decreases. A verbal warning order now is worth more than a written order one hour from now. The same warning orders used in the full MDMP should be issued when the process is abbreviated. In addition to warning orders, units must share all available information with subordinates, especially IPB products, as early as possible.

While the steps used in a time-constrained environment are the same, many of them may be done mentally by the commander or with less staff involvement than during the full process. The products developed when the process is abbreviated may be the same as those developed for the full process; however, they may be much less detailed and some may be omitted altogether.

When developing its plan, the staff may initially use the full process and develop branches and sequels during execution using the process when it is modified. A unit may use the complete process to develop the plan, while a subordinate headquarters uses the same process abbreviated.

The advantages of using the process when it is abbreviated are—

- It maximizes the use of available time.
- It allows subordinates more planning time.
- It focuses staff efforts on the commander's specific and directive guidance.
- It facilitates adaptation to a rapidly changing situation.
- It allows the commander to compensate for lack of a staff or for an inexperienced staff.

The disadvantages are—

- It is much more directive and limits staff flexibility and initiative.
- It does not explore all available options when developing friendly COAs.
- It may result in only an oral order or a fragmentary order.
- It increases the risk to the unit of overlooking a key factor or uncovering a significantly better option.
- It may decrease the coordination and synchronization of the plan.

The time saved on any step can be used to—

- Refine more thoroughly the commander's plan.
- Conduct a more deliberate and detailed war game.
- Consider in detail potential branches and sequels.
- Focus more on the actual rehearsal and preparation of the plan.

The Commander's Role

The commander decides what adjustments to make to the MDMP, giving specific guidance to the staff to focus the process and save time. If the commander has access to only a small portion of the staff or none at all, he will have to rely even more than normal on his own expertise, intuition, creativity, and battlefield awareness. He may have to decide on his course of action, mentally war-game the outcome, and confirm his decision to the staff all in a relatively short time. If so, his decision will be based more on his experience than on a formal integrated staff process. The commander may elect to have his staff spend most of its time developing, refining, and war-gaming his COA rather than developing multiple courses of action.

The commander should avoid changes to his guidance unless a significantly changed situation dictates major revisions. Frequent minor changes to the guidance can easily result in lost time as the staff makes constant minor adjustments to the plan.

The commander should consult with subordinate commanders before making a decision, if possible. Subordinate commanders are closer to the fight and can more accurately portray the enemy's situation and that of their own unit. Additionally, consulting with subordinates will give them insight into the upcoming operation and allow them to conduct parallel planning.

In situations where the commander must decide quickly, he should contact his higher headquarters and advise them of his selected COA as it may affect the branches and sequels his superiors are planning.

The Staff's Role

The importance of staff estimates increases as time decreases. Decision making in a time-constrained environment almost always takes place after a unit has entered into the area of operations and has begun to execute operations. This means that the IPB and some portion of the staff estimates should already exist. Detailed planning before operations provides the basis for information the commander and staff will need to make knowledgeable decisions as operations continue. Staff members must keep their estimates up to date so that when planning time is limited they can provide accurate, up-to-date assessments quickly and move directly into COA development. When time is short, the commander and staff use as much of the previously analyzed information and products from earlier decisions as possible. Although some of these products may change significantly, many, such as the IPB that is continuously updated, will remain the same or require little change.

The staff must use every opportunity to conduct parallel planning with the unit's higher headquarters. Parallel planning can save significant time, but if not carefully managed, it can also waste time. As a general rule, the staff must never get ahead of the higher headquarters in the planning process. The majority of time spent conducting parallel planning should be spent developing the foundation of the plan, such as mission analysis. The staff should not develop and analyze COAs without specific guidance and approval from higher headquarters.

Mission Receipt

This part of the process does not change in a time-constrained environment. However, the commander decides at this step whether or not to abbreviate the process and, if so, specifies how he wants to do it. See the discussion on page 5-3.

Mission Analysis

The commander's involvement is the key to saving time in mission analysis. He must get personally involved by supervising and managing the mission analysis process. If time is not available to conduct a detailed mission analysis, the commander and staff will rapidly perform mission analysis together to determine the restated mission.

The IPB process requires constant attention. Many delays during mission analysis can be traced to the IPB. The G2 (S2) must quickly update the IPB based on the new mission and changed situation. This is critical to allow needed reconnaissance assets to deploy early to collect information to adjust the initial plan. Enemy event templates must be as complete as possible prior to the mission analysis briefing. Because they are the basis for war gaming, they must be constantly updated as new information becomes available.

Staff officers conduct as formal a mission analysis briefing as time allows. However, they may be forced to brief their estimates orally, covering only information that has changed from the last staff estimate, without the use of charts or other tools. When severely time-constrained, they brief only critical information that directly affects the new mission. If the commander has been directly involved in the mission analysis, he may decide to skip the mission analysis briefing completely.

Commander's Guidance

A key way to save time is in the issuance of the commander's guidance. The elements of the commander's guidance may be the same as the full MDMP's, but the guidance is more detailed and directive. The commander can provide detailed information outlining what he expects in each COA developed, including tentative task organization and scheme of maneuver. He may also determine which enemy COAs he wants friendly COAs war-gamed against as well as the branches or sequels he wants incorporated in each COA. Detailed guidance keeps the staff focused by establishing parameters to

work within. Commander's guidance must be constantly reviewed and analyzed. As the situation changes and information becomes available, the commander may have to alter his guidance. This type of detailed guidance limits the staff's flexibility and initiative to save time, but it allows the staff more time to synchronize the COA during the war-game session.

Once the guidance is issued, the staff immediately sends a warning order to subordinate units.

Course of Action Development

Significant time is saved by increased commander involvement in COA development, resulting in detailed and directive commander's guidance. The greatest savings in time for the MDMP comes from the commander directing the staff to develop only a few courses of action instead of many.

The commander and selected staff save additional time by conducting a hasty war game once the COAs are developed. The hasty war game allows the commander to determine if he favors one or more COAs out of several proposed. It develops and matures one or more COAs prior to the formal war game. If the commander cannot be present during the hasty war-game session, then the staff conducts a COA backbrief to the commander after the hasty war game. From the hasty war game, the commander can make an early decision, allowing him to refine his COA and make any necessary adjustments prior to the detailed war game. In extreme situations, this may be the only opportunity to conduct the war-game process.

The hasty war game can also be used to select a single COA for further development. A commander's early decision to go with a single COA allows his staff to focus on the selected COA instead of on multiple COAs. It also allows the staff to concentrate on synchronizing the COA rather than on continuing to develop the COA during the formal war-game session.

When time is severely limited, the quickest process comes from the commander deciding to immediately begin personally developing *one* COA, with branch plans, against the enemy's most likely course of action. The commander determines which staff officers are critical to assist him in this phase, depending on the type of operation being planned. The minimum is normally the G2 (S2), G3 (S3), FSCoord, engineer coordinator (ENCOORD), and CofS (XO). The commander may also include subordinate commanders, if available. This

team must quickly develop a flexible COA that it feels will accomplish the mission.

Limiting the number of COAs developed carries with it the risk of overlooking a significantly better COA. Developing only one COA is the most risky approach. It provides the staff with the least flexibility to apply its creativity and explore options.

Saving time by not using the enemy event templates is a poor technique. The commander and staff must use the enemy event templates when developing COAs. Without them, they cannot conduct the analysis of relative combat power and the arraying of initial forces.

Course of Action Analysis

The commander and staff must war-game the COAs to ensure all elements are fully integrated and synchronized. An early decision to limit the number of COAs war-gamed, or to develop only one COA, saves the greatest amount of time in this process. When war-gaming the COAs, it is best to do so against all feasible enemy courses of action. However, the commander can save additional time by having the staff war-game against a smaller number of enemy COAs.

The commander's involvement can save significant time in this step by allowing the staff to focus on only the most essential aspects of the war game. The commander can supervise the war game and be prepared to make decisions, provide guidance, delete unsatisfactory concepts, and assist in keeping the staff focused. If the commander is present during the war gaming of multiple COAs, he may identify the COA he favors. He can then discard unwanted COAs, allocating more time to refine the selected COA.

The commander must always assess risk, especially since by limiting the number of COAs, he has increased risk to the command. He must evaluate the COA to ensure it will not render the force incapable of anticipated operations or lower the unit's combat effectiveness beyond acceptable levels.

The staff should use the box technique, focusing on the most critical event first, such as actions at the objective or the engagement area. If time permits, the staff war-games other critical events or boxes as well. The commander and staff must identify and prioritize the critical events they want analyzed. These critical events can be identified by analyzing essential tasks. The staff war-games as many critical events as possible in the allotted amount of time.

Staff officers save time if they specifically define and limit the evaluation criteria before they begin the war-game process. Significant factors can be quantified, if possible, and limited to the four or five most important, based on the mission statement, commander's intent, and commander's guidance.

The staff must work to support the commander's plan. However, as the staff refines the plan, it cannot become so biased that it develops a plan that is infeasible and insupportable. If the staff determines that it cannot support the commander's plan, a new COA must be developed.

The use of recorders is particularly important. These recorders should be trained to capture coordinating instructions, subunit instructions, and information required to synchronize the operation during the war-gaming process. If this occurs, a portion of the order is written before the planning process is complete.

The location used for the war game must be prepared and configured by the time the staff is ready to conduct the war game. Charts and boards must be cleaned and prepared for use. The blown-up terrain sketch and enemy SITTEMPs must be prepared and present for the war-game session.

When only one COA is developed, the purpose of the COA analysis is to verify, refine, synchronize, and integrate the commander's COA and recommend modifications as necessary. However, the analysis should follow the formal war-game process as much as time allows to help the commander visualize the outcome and identify potential branches and sequels. As time allows, the staff can further war-game and develop these branches and sequels.

Course of Action Comparison

If the commander decides to war-game only one COA, or if he chooses one during the war game, no course of action comparison is needed. If multiple COAs have been war-gamed and the commander has not made a decision, the staff must conduct the COA comparison detailed on page 5-24. Limiting the evaluation criteria is the only significant shortcut in this step.

Course of Action Approval

If the commander has observed and participated in the planning process, the decision may be rapidly apparent and the commander can make an on-the-spot decision. If the commander has not participated in the process to this point, or has not made a decision, a decision briefing will still be required. Good COA comparison charts and sketches assist the commander in visualizing and distinguishing between each COA. The staff must ensure the COAs are complete with tentative task organization, COA statement, and task and purpose for each subordinate unit. Time can also be saved by limiting the course of action briefing to only the most critical points.

If only one COA was developed, no decision is required, unless the developed COA becomes unsuitable, infeasible, or unacceptable. If this occurs, another COA must be developed.

Once the decision is made, the staff immediately sends out a warning order.

Orders Production

There are several ways to save time in orders production. These are addressed in Appendix H, Plans and Orders.

Chapter 6

STAFF OFFICER DUTIES DURING PREPARATION FOR AND EXECUTION OF OPERATIONS

The commander and his staff must prepare for execution of, and then execute, the operation planned during the military decision-making process. This requires combining both standard staff actions and unique skills in an environment characterized by rapidly changing situations, an enemy trying to disrupt the operation, and imperfect information arriving in increased quantities. For the staff, anticipation of key events, effective use of time, and clarity of communications (especially orders) are key to successful preparation for and execution of operations. Constantly updated estimates leading to timely decisions, communicated through clear, concise, and rapidly disseminated orders, are critical to successful execution. Chapter 4 discussed the common and specific duties of staff officers in general. This chapter discusses the general duties of the staff that assists the commander in the preparation for and execution of operations.

Once the order is issued, preparation consists of briefings, backbriefs, and rehearsals that the commander uses to confirm that his staff, subordinate commanders, and their staffs know the mission, the commander's intent, and the expected results from the operation horizontally as well as vertically. The commander and staff must review the plans of subordinate units to ensure the intent and the concept of operations are nested within all supporting plans. At any time during briefings, backbriefs, rehearsals, or reviews of subordinate orders, the commander may give additional guidance as needed to ensure the mission's overall coordination. It is particularly important to ensure that support plans are integrated with tactical plans.

NOTE: See Appendix G for a discussion of rehearsals.

Time permitting, after issuing the order, the staff considers specific branches of the current plan or contingency planning of future (sequel) operations. The commander and CofS (XO) decide the staff's priority of work as they monitor current operations, synchronize upcoming operations, and continue their estimates.

During execution of the order resulting from the decision process, the commander and staff must constantly assess where they are in the ongoing operation against what they thought would happen in the war game, to

include available resources, and estimate the force's posture for future operations. Rapidly changing time-space relationships, especially as they affect key actions, and the acquisition of new or changed information require staff officers to continually update their estimates. They continue to assess the operation as assumptions either become facts or are proved false. They are constantly on the lookout for unexpected opportunities to exploit success and for the events that will trigger branches and sequels. Finally, they must be looking for changes in conditions that will result in new or significantly altered missions and thus cause the decision-making process to start again. This is the value of the orders process.

During the preparation for and execution of the operation, the staff assists the commander in making timely decisions by providing him with critical information to support his battlefield visualization. This includes information about the enemy, friendly strengths and dispositions, and terrain and weather in which the battle takes place. It is the staff's responsibility to ensure that the commander has the most up-to-date, accurate information to make such decisions, the implications of that information for the operation, and staff recommendations on the decision to be taken. Staff members are also responsible for monitoring the preparation for and execution of the operation within each member's own functional area. Further, they identify variances from the plan, adjust the allocation and use of resources to support the plan in changing circumstances, and advise the commander when they can no longer make adequate adjustments without the commander's intervention. The key element in successful combined arms operations is maintaining synchronization in the force; all staff officers must focus their efforts to this end.

CHIEF OF STAFF (XO) DUTIES

The chief of staff (XO) supervises and coordinates the details of the operation in conformity with the commander's orders through his direction of all staff efforts

during operations. He advises the commander and informs the commander of critical information. He—

- Informs the commander, staff, and subordinate commanders of the progress in preparation for and execution of the operation through periodic intelligence and operations summaries.
- Ensures the staff provides the commander updated estimates and plans for future operations.
- Coordinates efforts among the staff to anticipate requirements and develop recommendations to the commander for correcting shortfalls, actual or forecasted, in resources or mission accomplishment.
- Supervises the staff's synchronization of the operation vertically, horizontally, chronologically, and geographically.
- Supervises the integration of risk management during the operation, identifying hazards, and recommending control measures to reduce risk.
- Supervises information flow in and out of the staff, including the analysis and assessment of all information and submission of recommendations to the commander.
- Supervises time management by setting and adjusting time lines.
- Supervises the movement of command posts.
- Ensures the continuity of staff support and communication under all circumstances.
- Ensures the staff gets adequate rest and placed where they can best support the commander.
- Maintains contact with the commander and keeps him informed of critical information, regardless of where the commander places himself during the operations.
- Knows who can make "what" decisions in the absence of the commander.

STAFF OFFICER DUTIES

During the preparation for and execution of operations, staff officers have two broad areas of responsibility. The first is providing information, assistance, and recommendations to the commander. The second is supervising the preparation for and the execution of the plan within their own functional areas. Specific responsibilities include anticipating requirements, monitoring operations, taking action to keep the plan

on track, managing the flow of information, making timely recommendations, conducting coordination, synchronizing operations, and maintaining continuity. All staff responsibilities require that staff officers know their authority to make decisions which affect the overall operation without the commander's approval and that they know the commander's intent. The commander specifies the staff's authority based on the staff officer's maturity and experience and the commander's confidence in the staff officer's abilities. This authority allows the staff officer to exercise initiative to operate within his area of responsibility when there is a deviation beyond tolerance from the original plan. Knowledge of the commander's intent guides specific decisions within the staff's authority.

During operations, the staff must continually keep in mind that the enemy will be trying to upset the friendly plan, desynchronize the operation, and destroy friendly units and defeat friendly actions. Enemy actions will often cause the staff to act and make decisions with less information and in less time than they would like.

Enemy actions and counteractions, as well as the fog and friction inherent in operations, almost guarantee that the operation will not unfold exactly according to the plan. The staff must identify unforeseen obstacles and problems and implement measures to reduce this friction whenever possible. When staff members cannot reduce friction or restore the plan on their own, they must report these problems to the commander and make recommendations in line with the commander's intent. As changes in the situation accumulate, the commander and staff have to remember to fight the enemy and not adhere strictly to the plan. Based on staff input and his own battlefield visualization, the commander must then decide to try to restore the plan, adjust the plan, or make major changes. As all this is taking place, the staff must conduct continuous risk management, identifying hazards affecting the operation and recommending control measures to reduce risk to the force.

Every staff officer must effectively manage time and the time line for his area of responsibility. He must synchronize this time line with the unit's time lines. Continuous synchronization by the staff is necessary for the four basic time lines—troop-leading procedures (TLPs), friendly critical events, logistics, and enemy critical events. The staff can thus identify required actions, decisions, and recommendations. During the planning process, planners use input from staff members' current operations time lines to develop the time line for future operations. The XO and S3 then identify critical events

which require tracking and linkage to the decision-making process.

Identifying and Anticipating Requirements

A principal responsibility of the staff during the preparation for and execution of operations is providing the commander with information. The commander identifies for the staff the key information (such as CCIR) he needs to conduct the operation, focusing on critical decision points. As the operation progresses, the CCIR will change often and both the commander and staff must review them for continued applicability. The CCIR should be limited to 10 or less. The smaller the number, the better the staff can focus its efforts. However, the staff must be aware that unforeseen events and information not included in the CCIR may directly impact on the operation. (See Appendix I.)

Staff members develop criteria for collecting both CCIR and information needed in their own functional areas to monitor the preparation for and execution of the operation. This information allows the staff to anticipate when additional resources are required, when a branch or sequel should be executed, or when and how future operations may develop. Anticipation of requirements involves analyzing this information and forecasting trends or events based on that information.

Monitoring Operations

Monitoring involves measuring, analyzing, and reporting performance to compute or otherwise identify variance from the plan or its assumptions, and to forecast change. Monitoring looks at factors such as time lines, distances, loss rates, consumption rates, unit effectiveness, enemy actions, and facts and assumptions used to formulate the plan.

A plan is developed based on various facts and assumptions. The staff tracks these to ensure they remain valid and to seek new facts and assumptions that will affect current or future operations. If the facts change or assumptions become invalid during preparation for or execution of the operation, the staff evaluates what effect this will have on the operation. If the deviation becomes critical to the operation, the staff informs the commander and recommends a remedy for the situation.

Monitoring also includes each staff officer looking at the movement, actions, and reactions of the enemy in relation to that officer's functional area. This monitoring

includes all enemy activities that might affect the friendly force throughout the duration of the operation and extends to the entire area of interest to anticipate future operations. The staff uses this information to determine if enemy actions are consistent with expectations and war-gaming results, to provide insight into how the enemy course of action will develop, to identify high-payoff targets, to conduct predictive analysis based on the tactical situation to determine enemy intentions and actions that might cause a change to the plan, and to update staff estimates. This information is used to support the commander's battlefield visualization. Critical information is to be immediately reported to the commander.

The staff must have a system to effectively monitor both the preparation for the operation and its execution. This system should be clearly articulated in the unit SOP. As a minimum, the staff should monitor the following enemy information:

- Terrain information (such as axis of advance, key terrain, crossing sites).
- Contacts, withdrawals, locations, and movements.
- Employment of NBC assets and weapons.
- Battle damage assessments.
- Combat power.
- Units capable of reinforcing or supporting the operation.
- Support capabilities including any significant changes.
- Obstacles.

The staff should monitor the following friendly information:

- Changes in mission.
- Status of critical classes of supply, especially Class III and V, and other critical CSS assets.
- Combat power.
- Unit locations and activities, particularly defensive preparation status.
- Changes in status of supporting fires or priority of close air support.
- Loss of combat effectiveness.
- Status and location of reserve forces.
- Changes in status of critical major organic items.

- Main aid station and forward aid station locations.
- Assets in sector (such as ground surveillance radar, military police, patrols) not belonging to the controlling headquarters.
- Status and location of adjacent units.
- Fire support control measures.
- Obstacles and effective times.
- Decision points.
- Nongovernmental organizations and civilians in the area of operations.

Directing Actions

Directing involves taking or recommending action to deal with forecasted changes or deviations by acquiring and applying means to accomplish the commander's intent and correcting deviations from the plan or guidance. The staff must sort out the critical data by analyzing specific information to determine if the operation is deviating significantly from the plan. If it is, the staff, within its authority, tries to get the plan's execution back on track. The staff acts to bring that portion of the operation back into tolerance based on the staff members' understanding of the commander's intent. This may mean anything from a minor adjustment of resource allocation to a major shifting of priorities. The commander is notified if the staff determines there is critical information affecting the operation which is outside the staff's authority to adjust.

Managing Information

The staff's ability to operate effectively during the preparation for and execution of an operation revolves around how staff members manage information. A staff officer must be able to receive, analyze, process, and distribute massive volumes of information quickly and efficiently. All information is not of the same importance and cannot be processed the same way. Information management is a balancing act between providing too much information, which will overload the commander and slow down the decision process, and providing too little information, which can lead to poor decisions.

As the battle progresses, the volume of information increases significantly. The commander establishes filters for information reporting, the most important of which are the CCIR. This helps eliminate extraneous reports and allows the staff to recognize key events that demand the commander's attention. The CofS ensures

the staff analyzes the information and provides the commander only information necessary to make decisions.

The staff must establish and practice, prior to the commencement of operations, an SOP to effectively manage all the information. This SOP must include standard displays the commander feels comfortable in using for decision making, and procedures and techniques the staff uses to report critical information.

The first step in managing information is to analyze information to determine whether it is critical, exceptional, or routine. (See Appendix I.) The staff officer must know the commander's intent and the concept of the operation, and be current on how the preparation for and execution of the operation are proceeding in order to interpret what the information means and how critical it is. This means the staff member must not only know how his functional area is progressing in detail, he must understand how the preparation for or execution of the operation is progressing overall. Without a broad knowledge of the situation, the staff member may misinterpret the information's criticality.

The next step is to decide what to do with the information—how to properly display and disseminate it. A map is an effective visual information display for the commander to see a snapshot of the operation. From one map, the commander should get a reasonably complete situation report (SITREP) of the critical information about a unit and the current operation without having to ask numerous questions of staff officers. The map also gives the staff a quick and efficient means of displaying critical information for other staff officers. Status boards and charts are other visual methods for staff officers to effectively display critical information. However, the staff must avoid having too many, or unnecessary, charts that might contribute to information overload or avoid putting so much information on maps, charts, and overlays that updating them is difficult. The staff's use of matrixes, logs, and journals is also important. Modern automation technology will add new means to display, store, and disseminate information.

The staff must have a means to disseminate information and any orders that result from the commander's analysis of that information. For subordinate and supporting units, this is normally a fragmentary order (FRAGO) or a warning order (WARNO). The order may be oral, in the form of an overlay, or in written format. (See Appendix H.) The use of WARNOs is particularly critical during the execution of operations. It allows subordinate elements maximum time for parallel planning and

preparation for branches, sequels, and new missions. The clarity of FRAGOs and WARNOs is essential. During the conduct of operations, there is much less time for clarification than during preparation for execution.

The staff disseminates this information among the staff sections within its own headquarters according to its SOP. The SOP should include who gets what kind of information and in what priority. All staffs should have access to all information, but they do not all need it in the same priority. Establishing what information is critical to what staff section and who needs critical information quickly is an important part of staff coordination. The information may not always fit a specific category in the SOP. As they evaluate any unusual information, all staff officers should be asking themselves, "Who else needs this information?" Most important, CSS operators must be kept fully informed of the progress of the operation.

Finally, the staff disseminates information to higher and adjacent headquarters using standard reports. Knowledge of the higher commander's CCIR helps a staff determine what priority to assign to information going to higher headquarters.

Making Recommendations

If the staff officer has done everything within his authority to bring the plan back on track, but has been unsuccessful, or lacks the assets or authority to make it happen, he must then make a recommendation to the commander to resolve the problem. Knowing both the assets available within the command and from higher headquarters and the commander's intent is the key to determining a recommendation. Basic recommendations during operations include that the commander—

- Intervene to direct something that is not in the staff officer's delegated authority to put the operation back on track.
- Commit, or acquire and commit, resources not controlled by the staff officer to put the plan back on track.
- Change the plan. (This recommendation should include the who, what, when, where, how, and why for the change.)

Recommended changes to the plan may include that the commander execute a branch or a sequel identified during the planning process. The recommendation should support the commander's intent and facilitate future operations. It must address the change's advantages, disadvantages, risk to the force, supportability, and overall effect on the operation.

Conducting Coordination

During preparation for and execution of operations, continuous coordination by the staff officer is critical. This includes coordinating vertically and horizontally to exchange information and coordinate actions that may impact on the staff officer's area or other functional areas. Coordination aims to reduce confusion and problems while maximizing the synchronization of the plan. It is particularly important to conduct thorough coordination when subordinate units change their execution of the plan directed by the issuing headquarters.

Synchronizing Operations

During preparation for and execution of an operation, the staff helps the commander synchronize the operation to produce maximum combat effects on the enemy. This involves synchronizing the operation in space and time across the battlefield functional areas with respect to the close, deep, and rear operations to gain or retain the initiative. Synchronization involves every staff officer understanding his part in the operation and how it relates to everyone else's while supporting the commander's intent.

Maintaining Continuity

During the preparation for and execution of operations, the staff must maintain continuity to reduce turmoil. Continuity requires planning for continuous 24-hour-a-day operations. This includes plans for shift changes in command posts, sleeping, eating, command post displacements, operations during WMD strikes, provisions for individual casualties or destruction of entire command posts, and maintenance of communications under all conditions. Each staff section must establish what information and procedures everyone needs to know and how they will be updated. This includes the commander's intent, the current mission, CCIR, shift-change procedures, maintenance of situational awareness through periodic staff huddles, and staff drills for actions such as mission planning and orders production. Continuity also includes distributing the staff section among the various command posts to cover each functional area in those command posts that need it.

Continuity is provided by operating in consonance with a detailed headquarters operations SOP. All members of the staff should know the SOP and have practiced all its measures to ensure continuity.

Appendix A

MISSION ANALYSIS GUIDELINES

Prior to the mission analysis briefing, staff officers must know the status of subordinate units, limitations and capabilities of weapons systems, area of operations, area of interest, enemy situation and capabilities, and time available. They must understand the mission and intent of higher headquarters. Each staff officer must bring with him to the mission analysis technical knowledge, estimates, and historical data as required.

This appendix provides guidelines for the staff officer to consider as he prepares for the mission analysis brief. This list is not all-inclusive. It is generic and should be reviewed and revised to meet individual needs. Staff officers not listed can use the following examples.

All Staff Officers

1. Specified and implied tasks.
2. Mission-essential tasks.
3. Constraints.
4. Time considerations.
5. Recommended CCIR.

G1 (S1)

1. Personnel status of organic and attached units.
2. Forecasted personnel status.

Surgeon

Civilian and military medical assets available (including Class VIII supply status).

G2 (S2)

Initial IPB, including the following:

- Define battlefield environment.
- Define battlefield effects.
- Evaluate the threat, to include:
 - Enemy combat power.
 - Enemy vulnerabilities.
 - Threat COAs (arranged in order of probability of adoption).
- Determine assets available.

G3 (S3)

1. Current combat power.
2. Current situation of subordinate units and activities.
3. Status of task organization.
4. Assets available.
5. Mission and intent two levels up.

G4 (S4)

1. Maintenance status.
2. Forecasted combat vehicle and weapons status.
3. Supply status of Classes I, II, III, IV, V, VII, and IX supplies.
4. Transportation assets available.
5. Availability and status of services.
6. Host nation and foreign nation support.

G5 (S5)

1. Displaced civilian movement, routes, and assembly areas.
2. Ability of host nation to care for civilians.
3. Host nation and foreign nation support.
4. Protected target list, including cultural, religious, historical, and high-density civilian population areas.
5. Nongovernment and private volunteer organizations; independent organizations operating in the area of operations.

G6 (S6)

1. Unit communications maintenance status.
2. Higher headquarters' signal plan.

FSCCOORD

1. Fire support capabilities.
2. Recommended tasks for fire support.

3. High-value targets (HVTs) by critical events.
4. Impact of IPB, target-value analysis (TVA), and battlefield geometry on fire support.
5. Protected target list, including cultural, religious, historical, and high-density civilian population areas.

ENCOORD

1. Engineer assets available.
2. Capabilities with available assets (for example, number of fighting positions; number, size, and density of minefields, and meters of antitank ditch; smoke assets; and nuclear demolition assets).
3. Terrain visualization support through engineer battlefield assessment (EBA).

ADCOORD

1. Current C² measures for air defense assets (AD warning, weapons control status).
2. Enemy air capabilities (most likely air avenues of approach, type and number of sorties, HVT list).
3. Air defense assets available.

NBC

1. Assets available, to include reconnaissance, decontamination, smoke, and constraints.
2. MOPP status.
3. NBC threat status.
4. Troop safety criteria.

Appendix B

COMMANDER'S GUIDANCE GUIDELINES

This appendix provides commanders a ready-to-use tool to help them develop their guidance. The contents of the commander's guidance will vary depending on the situation. This list is not designed to meet the needs of all situations. It is a generic list of information commanders may consider as they develop their guidance. *It is neither mandatory nor desired that the commander address every item listed below while developing or providing his guidance.* The commander's guidance should be tailored to meet specific needs and the commander will issue guidance on only those items appropriate to a particular mission.

Intelligence

1. Enemy COAs to consider during the COA development and COA analysis phase of the planning process. This may be the enemy's most probable COA, most dangerous COA, or a combination of the two.
2. Enemy's critical decision points and vulnerabilities.
3. PIR (CCIR).
4. Targeting guidance.
5. High-value targets.
6. Defining of the enemy commander's mission.
7. Defining of the enemy commander's method.
8. Desired enemy perception of friendly forces.
9. Intelligence focus for reconnaissance and security effort.
10. Reconnaissance and surveillance guidance.
11. Specific terrain and weather factors to consider.
12. Use of organic assets: combat operation laser teams (COLTs), intelligence and electronic warfare (IEW), task force (TF) scout platoons.

Maneuver

1. Initial intent:
 - Purpose of operation.
 - Method (phases/sequences).

- Desired end state.
2. Concept of operations:
 - Decisive point.
 - Battlefield organization (close, deep, rear).
 - Task/purpose.
 - Resources to be used for each.
 3. COA development guidance:
 - Critical events.
 - Number of COAs to be developed.
 - COAs to consider or not consider and formations to consider.
 - Shaping of battlefield.
 - Defeat mechanism.
 - Main and supporting effort.
 - Task organization.
 - Where/what risk to accept.
 - Task/purpose of subordinate units.
 - Reserve guidance (composition, mission, priorities, command and control measures).
 - Reconnaissance or counterreconnaissance guidance.
 - Composition.
 - Command and control measures.
 - FFIR (CCIR).
 4. Reconnaissance and surveillance guidance and priorities.
 5. OPSEC considerations.

Fire Support

1. High pay-off targets:
 - Methods of engagement (maneuver, lethal, nonlethal).
 - Desired effects.
2. Guidance for fires.

FM 101-5

3. Observer plan.
4. Employment of COLTs.
5. Requirements, restrictions, and priorities of special munitions.
6. Task and purpose of fires.
7. Counterfires and use of radars.
8. Suppression of enemy air defenses (SEAD) guidance.
9. Critical zones.
10. Critical friendly zones (CFZs) and call for fire zones (CFFZs).
11. Fire support coordination measures.
12. Synchronization and focus of fires with maneuver.
13. Attack guidance.
14. Protected target list. Include cultural, religious, historical, and high-density civilian populations areas.

Mobility and Survivability

1. Priority of effort and support.
2. Mobility:
 - Breaching/bridging guidance.
 - Employing assets guidance.
3. Countermobility:
 - Obstacle effects/emplacement guidance.
 - FASCAM use and duration.
4. Survivability: Assets available to dig survivability positions.
5. NBC defense operations:
 - Chemical reconnaissance assets.
 - MOPP posture guidance.
 - Decontamination guidance.
 - Masking and unmasking guidance.
 - Employment of smoke.
 - Detection, reporting, marking.
6. Management of engineer supplies and materiel.
7. Environmental guidance.

Air Defense

1. Protection priorities.
2. Positioning guidance.
3. Weapons control status for specific events.

Information Operations

1. Military deception guidance:
 - Amount and types of resources to commit to the deception plan.
 - Intent for exploiting the enemy actions.
 - EEFI (CCIR).
2. OPSEC considerations:
 - Identification of actions that can be observed by the enemy.
 - Determination of indicators from which enemy intelligence systems can gain critical information.
 - Selection of measures to reduce vulnerabilities.
3. Electronic warfare (EW) considerations:
 - Measures for electronic protect (EP).
 - Support needed for electronic warfare support (ES).
 - Methods of electronic attack (EA).
4. Physical destruction considerations:
 - Planned indirect fire support targets to support C²W plan.
 - Maneuver actions to suppress, neutralize, and destroy enemy.
 - Air defense measures to nullify enemy aircraft.
5. PSYOP consideration:
 - Priority of effort for attached PSYOP forces.
 - Allocation of organic and or supporting resources to support PSYOP efforts (field artillery, close air support, unmanned aerial vehicles, security elements).
6. Public affairs (PA) considerations:
 - Effective publications that are dependent on credibility.
 - Early deployment of public affairs personnel.
 - Information security practiced at the source.

Combat Service Support

1. Commander's guidance for CSS:
CSS priorities in terms of manning, fueling, fixing, arming, moving, and sustaining.
2. Location of CSS assets.
3. MEDEVAC treatment and evacuation guidance.
4. Classes of supply:
Anticipated requirements and prestockage of Class III, IV, and V.
5. Controlled supply rates.
6. Guidance on construction and provision of facilities and installations.

Command and Control

1. Rules of engagement.
2. CP positioning guidance.
3. Position of commander.
4. Integration of retransmission assets or other communications equipment.
5. LNO guidance.
6. Force protection measures.
7. Time-line guidance.
8. Type of order and rehearsal.
9. Specific signal guidance.

Appendix C

STAFF ESTIMATES

Mission analysis, facts and assumptions, and the situation analysis (of the area of operations, area of interest, and enemy, friendly, and support requirements) furnish the structure for the staff estimate. The estimate consists of significant facts, events, and conclusions based on analyzed data. It recommends how to best use available resources. Adequate, rapid decision making and planning hinge on good, timely command and staff estimates. They are the basis for forming viable courses of action. Failure to make estimates can lead to errors and omissions when developing, analyzing, and comparing COAs.

This appendix discusses the qualities that are essential to staff estimates, and the types of estimates. Further, it provides a generic staff estimate to standardize the way staff members construct their estimates.

ESSENTIAL QUALITIES OF ESTIMATES

Commanders control battlefield tempo by making and executing decisions faster than the enemy. Therefore, commanders must always strive to optimize time available. They must not allow estimates to become overly time-consuming. However, they must be comprehensive and continuous and must visualize the future.

Comprehensive estimates consider both the quantifiable and the intangible aspects of military operations. They translate friendly and enemy strengths, weapons systems, training, morale, and leadership into combat capabilities. The estimate process requires a clear understanding of weather and terrain effects and, more important, the ability to visualize the battle or crisis situations requiring military forces. Estimates must provide a timely, accurate evaluation of the unit, the enemy, and the unit's area of operations at a given time.

The demand on the C² system is *continuous* as opposed to cyclical. Estimates must be as thorough as time and circumstances permit. The commander and staff must constantly collect, process, and evaluate information. They update their estimates—

- When the commander and staff recognize new facts.

- When they replace assumptions with facts or find their assumptions invalid.

- When they receive changes to the mission or when changes are indicated.

Estimates for the current operation can often provide a basis for estimates for future missions as well as changes to current operations. Technological advances and near-real-time information estimates ensure that estimates can be continuously updated.

Estimates must *visualize the future* and support the commander's battlefield visualization. They are the link between current operations and future plans. The commander's vision directs the end state. Each subordinate unit commander must also possess the ability to envision the organization's end state. Estimates contribute to this vision.

TYPES OF ESTIMATES

The commander and his staff make estimates that apply to any operational situation and all levels of command. They use estimates to look at possible solutions to specific operational missions and requirements. These estimates can form the cornerstone for staff annexes to orders and plans.

The coordinating staff and each staff principal develop facts, assessments, and information that relate to their functional field or operating system. Types of estimates generally include, but are not limited to—

- The commander's estimate.
- Operations estimate.
- Personnel estimate.
- Intelligence estimate.
- Logistics estimate.
- Civil-military operations estimate.
- Signal estimate.
- Special staff estimates.

Normally, commanders and staffs do not produce written estimates. Units normally do staff estimates by

exception, graphically representing data and statistics on charts to assist the commander in decision making.

Commander's Estimate

The commander's estimate, like the operations estimate, is an analysis of all the factors that could affect a mission. The commander integrates his personal knowledge of the situation, his analysis of METT-T factors, the assessments of his subordinate commanders, and any relevant details he gains from his staff.

Estimate analysis includes risk assessment, force protection, and effective utilization of all resources. The estimate also includes visualizing all reasonable COAs and how each COA would affect friendly forces.

The commander's and operations estimates generally follow the same format. However, the commander's estimate deals more with assessing the intangibles of training, leadership, and morale, and it results in a decision. The commander uses his personal estimate as a cross-check of his staff's estimates.

Operations Estimate

The G3 (S3) prepares the operations estimate, which considers all elements that can influence the unit's current operations and feasible future courses of action. It results in a recommendation to the commander. To prepare this estimate, the G3 (S3) must understand—

- The commander's intent (one and two echelons above).
- The risk assessment.
- The current task organization (two echelons below).
- The unit's status, such as locations, combat capabilities (including level of training, effectiveness, degree of mobility, type of equipment, radiation exposure, and limitations), and current missions.
- The availability and capabilities of joint assets, such as air support, naval gunfire, or amphibious assets.
- Other information, such as location, status, and mission of flank and supporting units.

Personnel Estimate

The G1 (S1) prepares the personnel estimate, which is an analysis of how all human resources and personnel factors impact soldier and unit effectiveness before, during, and after the mission. It includes a current overall

personnel status of the organization, its subordinate units, and any attached or supporting elements. Personnel status includes assessments of the following tangible and intangible factors:

- Medical evacuation and hospitalization.
- Unit-strength maintenance.
- Replacements.
- Soldiers' readiness.
- Organizational climate.
- Cohesion.
- Discipline, law and order.

The personnel estimate predicts losses (where and when losses could occur) and when, where, and if such losses cause the culmination of an operation. It contains the G1's (S1's) conclusions and recommendations about the feasibility of supporting major operational and tactical missions.

Intelligence Estimate

The G2 prepares the intelligence estimate. Both the G2 (S2) and the G3 (S3) examine the area of interest to identify intelligence-collection needs.

Logistics Estimate

The G4 prepares the logistics estimate, which provides an accurate and current assessment of the CSS situation of the organization, its subordinate units, and any attached or supporting elements. The logistics estimate is an analysis of how service support factors can affect mission accomplishment. It contains the G4's (S4's) conclusions and recommendations about the feasibility of supporting major operational and tactical missions. This estimate includes how the functional areas of supply, transportation, services, maintenance, labor, facilities, and construction affect various COAs.

Civil-Military Operations Estimate

The G5 (S5) prepares the civil-military operations (CMO) estimate in relation to the situation and his functional responsibilities.

Signal Estimate

The G6 (S6) prepares the communications estimate in relation to the situation and his functional responsibilities.

Special Staff Estimates

Each special staff officer creates his own staff estimate in relation to the situation and his functional responsibilities. A staff officer may also make such estimates when performing dual roles, for instance, when he functions as both a subordinate unit commander and a special staff officer.

STAFF ESTIMATE FORMAT

The single generic staff estimate format, shown below, standardizes the way staff members construct estimates. The G2 (S2) (with input assistance from all staff members) will still conduct and disseminate the initial intelligence preparation of the battlefield as a separate product.

1. MISSION. Restated mission resulting from the mission analysis.

2. SITUATION AND CONSIDERATIONS.

a. Characteristics of area of operation.

(1) Weather. How will different military aspects of weather affect specific staff area of concern and resources?

(2) Terrain. How will aspects of the terrain affect specific staff areas of concern and resources?

(3) Other pertinent facts. Analyses of political, economic, sociological, psychological, and environmental infrastructure, as they relate to the area.

b. Enemy Forces. Enemy dispositions, composition, strength, capabilities, and COAs as they affect specific staff area of concern.

c. Friendly Forces.

(1) Friendly courses of action.

(2) Current status of resources within staff area of responsibility.

(3) Current status of other resources that affect staff area of responsibility.

(4) Comparison of requirements versus capabilities and recommended solutions.

(5) Key considerations (evaluation criteria) for COA supportability.

d. Assumptions.

3. ANALYSIS. Analyze each COA using key considerations (evaluation criteria) to determine advantages and disadvantages.

4. COMPARISON. Compare COAs using key considerations (evaluation criteria). Rank order COAs for each key consideration. Comparison should be visually supported by a decision matrix.

5. RECOMMENDATION AND CONCLUSIONS

a. Recommended COA based on the comparison (most supportable from specific staff perspective).

b. Issues, deficiencies, and risks with recommendations to reduce their impacts.

Appendix D

STAFF STUDIES AND DECISION PAPERS

This appendix gives steps and information on preparing staff studies and decision papers. Formats for both are also provided.

STAFF STUDIES

To solve a problem, a staff officer must research the problem to identify issues, develop and evaluate alternatives, and recommend effective action based on relevant facts. The staff study is one means to present his findings. Because a staff study generally conforms to the problem-solving model, it is both a formal military problem-solving process and a format. The staff study is the written form of a decision briefing.

Preparing the Staff Study

Procedures for preparing a staff study include the following seven steps:

1. Identify and state the problem. This step is crucial as the actual problem may not at first be obvious. Therefore, before undertaking the study, the staff officer must determine exactly what the problem is and precisely and clearly define the problem's scope and limitations. He then writes the problem statement as an infinitive phrase and submits it for approval to the authority directing the study. The directing authority also approves any later changes in the staff study's scope or direction.

2. List facts and assumptions. After completing the problem statement, the staff officer lists all facts bearing on the problem. If crucial facts are not available, the staff officer uses valid assumptions to replace facts and describe conditions he must fulfill before accepting the conclusions without reservation. The staff officer states the assumption in the future or conditional tense (for example, will or might be this or that). Assumptions are grounded in factual information. They are statements that may or may not be true; however, available data indicate that they are true or will be true at some time in the future. A valid assumption would be a fact if current data could prove it.

3. Develop possible solutions. After listing all known facts and valid assumptions, the staff officer poses possible solutions. He may want to brainstorm

possible solutions before doing intensive research. An "obviously best" solution is rare. After extensive evaluation, the staff officer selects the best available solution, screening out infeasible or unacceptable alternatives. He analyzes the remaining alternatives against previously determined evaluation criteria using an "advantages and disadvantages" format.

4. Research and collect data. After developing possible solutions, he begins to collect additional corroborating facts. Primary sources of information are official documents, technical reports, manuals, previous staff studies, and resources available from libraries. The staff officer may also find information in sources such as technical libraries, bibliographies and abstracts, and the Defense Document Center. If time permits, and if it seems appropriate, the staff officer can supplement official data with original data from persons intimately connected with the problem, including experienced local colleagues, subject-matter experts, and operational personnel who have first-hand knowledge of the problem. Methods to consider for collecting original data might include interviews (either by telephone or personal visits), letter requests for specific information, or questionnaires administered to operational personnel.

5. Interpret data. As data collection progresses, the staff officer begins to pare his list of possible solutions. He should reject all unsuitable alternatives. He may also identify areas of potential disagreement. Dealing with this now helps eliminate or reduce possible nonconcurrences. During the research, the staff officer should ask, "Is this solution feasible? acceptable? suitable?" Feasible solutions are those that can be implemented with available resources. Acceptable solutions are those worth the cost or risk involved in their implementation. Suitable solutions are those that actually solve the problem. Looking at feasibility, acceptability, and suitability will help direct further research by eliminating unsatisfactory solutions, identifying solutions, and checking them for nonconcurrences. It will also call attention to the facts and evaluation criteria needed for evaluating alternative solutions.

6. Evaluate alternative solutions. To do the staff study properly, the staff officer must consider all reasonable alternatives (courses of action) as possible solutions. The staff officer relates the evaluation criteria

to the known facts and valid assumptions. These criteria serve as the yardstick against which he measures all alternatives. Next, the staff officer compares and contrasts the alternatives. If he uses quantitative techniques, such as a decision matrix, he should use them as back-up data, place them in an annex, and refer to them in paragraph 5 of the staff study. The best solution will be the most feasible, suitable, and acceptable solution fulfilling evaluation criteria.

7. Prepare the staff study. The staff study consists of a summary sheet (body) and annexes. Along with the 10 basic paragraphs, the summary sheet may include—

- A list of annexes.
- Concurrences.
- Nonconcurrences.
- Considerations of nonconcurrences.
- A list of annexes added to summarize lengthy nonconcurrences and their considerations.
- Action by the approving authority.
- An implementing document.

Annexes contain details and supporting information. The staff officer uses them to keep the summary sheet concise so that readers can use it as a ready reference. Annex A contains implementing memorandums, directives, or letters submitted for signature or approval. Other annexes contain detailed data, lengthy discussions, execution documents, and bibliographies. The staff officer uses appendixes and tabs with capital letters. For example, page A-III-C-5 represents Annex A, Appendix III, Tab C, Page 5.

NOTE: See also Appendix H.

Coordinating the Staff Study

Conducting staff studies normally involves coordination with other staff officers to obtain concurrences or nonconcurrences on desired recommendations and other aspects of the study. The staff officer should anticipate

nonconcurrences. He should write considerations of nonconcurrence, assess them objectively and accurately, and make them into enclosures (annexes) to the staff study.

NOTE: See Figure D-1 for an example of an annotated format for a staff study. Use memorandum format in accordance with AR 25-50.

Common Problems of Staff Studies

The following is a list of the most common problems found in staff studies. Staff officers should review this list before beginning a staff study. While completing the staff study, the officer evaluates it using these questions:

- Is the topic too broad?
- Is the problem properly defined?
- Are facts or assumptions clear and valid?
- Are there any unnecessary facts or assumptions?
- Are there any facts that appear for the first time in the discussion?
- Are there a limited number of options or courses of action?
- Are evaluation criteria invalid or too limited?
- Is the discussion too long?
- Is the discussion incomplete; must the reader look at annexes?
- Does the conclusion include a discussion?
- Is the logic incorrect or incomplete; does the conclusion follow from analysis?
- Can the solution be implemented within resource or time constraints?
- Do the conclusions and recommendations answer the problem?
- Is there an “implementing” directive?
- Have new criteria been introduced?

Office Symbol (Marks Number)

Date

MEMORANDUM FOR

SUBJECT: Briefly describe the study's contents. Be specific. Do not just say Staff Study.

1. Problem. Write a concise statement of the problem, stated as a task, in the infinitive or question form; for example, *To determine....* or *How to....* Normally include the *who, what, when, and where* if pertinent.

2. Recommendation. Recommend a specific course of action (who, what, when, and where). *The recommendation must solve the problem.* If necessary or directed, place an implementing document at Annex A.

3. Background. Provide a lead-in to the study, briefly *stating why the problem exists.*

4. Facts. State facts *that influence the problem or its solution.* Make sure the facts are stated and attributed correctly. The data must stand alone; either it is a clear fact or is attributed to a source that asserts it true. There is no limit to the number of facts. Provide all the facts relevant to the problem (not just the facts used to support the study). State any guidance given by the authority directing the study. Refer to annexes as necessary for amplification, references, mathematical formulas, or tabular data.

5. Assumptions. Identify any assumptions necessary for a logical discussion of the problem. If deleting the assumption has no effect on the problem, you do not need the assumption.

6. Courses of Action. List *all* possible suitable, feasible, acceptable, distinguishable, and complete courses of actions. If a course of action (COA) is not self-explanatory, include a brief explanation of what the COA consists of to ensure the reader understands. If the COA is complex, refer to an annex for a complete description (including pertinent COA facts).

a. COA 1. *List specifically by name, for example, Route A.*

b. COA 2. *Same as above.*

c. COA 3. *Same as above.*

7. Criteria. List the criteria used to judge COAs. Criteria serve as yardsticks or benchmarks against which to measure each COA. Define criteria to ensure the reader understands them. Be specific. For example, if using cost as a criterion, talk about that measurement in dollars. *Use criteria that relate to the facts and assumptions.* There should be a fact or an assumption listed in paragraph 4 or 5, respectively, that supports each of the criteria. The sum of the facts and assumptions should at a minimum be greater than the number of criteria. Consider criteria in three related but distinct areas, as indicted below.

a. Screening Criteria. Define screening criteria that a COA must meet to be suitable, feasible, acceptable, distinguishable, and complete. *Accept or reject a COA based solely on these criteria.* Define each criterion and state the required standard in absolute terms. For example, using cost as a screening criterion, define cost as "dollars" and specify the maximum (or minimum) cost you can pay. In subsequent subparagraphs, describe failed COAs and state why they failed.

b. Evaluation Criteria. This is criteria used to measure, evaluate, and rank-order each COA during analysis and comparison paragraphs. Use issues that will determine the quality of each COA and *define how to measure each COA against each criterion and specify the preferred state for each.* For example, define cost as total cost including research, development, production, and distribution in dollars—less is better; or cost is manufacturer's suggested retail price—less is better. *Establish a dividing line that separates advantages and disadvantages for a criterion.* An evaluation criterion must rank-order COAs to be valid.

Some criteria may be both screening and evaluation criteria, such as, cost. You may use one definition of cost; however, the required or benchmark value cannot be the same for both screening and

Figure D-1. Format for a staff study

evaluation criteria. If the value is the same, the criteria will not distinguish between advantages and disadvantages for remaining COAs.

(1) Define Evaluation Criteria. Each evaluation criterion is defined by five elements written in paragraph or narrative form.

- A short title. (“Cost,” for example.)
- Definition. (The amount of money to buy . . .)
- Unit of measure. (For example, US dollars, miles, acres.)
- Dividing line or benchmark. (The point at which a criterion becomes an advantage. Ideally the benchmark should result in gaining a tangible benefit. Be able to justify how you came up with the value—through reasoning, historical data, current allocation, averaging.)
- Formula. (Stated in two difference ways. That “more or less is better” {\$400 is an advantage, >\$400 is a disadvantage, less is better} or subjectively in terms such as “a night movement is better than a daylight movement.”)

(2) Evaluation Criterion #2. Again define and write the criterion in one coherent paragraph. To curtail length, do not use multiple subparagraphs.

(3) Evaluation Criterion #3, and so on.

c. Weighting of Criteria. Establish the relative importance of one criterion over the others. Explain how each criterion compares to each of the other criteria (equal, favored, slightly favored), or provide the values from the decision matrix and explain why you measured the criterion as such.

NOTE: Screening criteria are not weighted. They are required, absolute standards that each COA must meet or the COA is rejected.

8. Analysis. For each COA, list the advantages and disadvantages that result from testing the COAs against the stated evaluation criteria. Include the payoff value for each COA as tested. *Do not compare one COA with the others* (that is the next step). *Do not introduce new criterion.* If there are six criteria, there must be six advantages or disadvantages (as appropriate) for each COA. If there are many “neutral” payoffs, examine the criteria to ensure they are specific and examine the application of the criteria to ensure it is logical and objective. Neutral should rarely be used.

a. The first subparagraph of the analysis should state the results of applying the screening criterion if not already listed in paragraph 7a(2). List screened COAs as part of paragraph 7a for clarity and unity.

b. COA 1. (List the COA by name.)

(1) Advantage(s). List the advantages in narrative form in a single clear, concise paragraph. Explain why it is an advantage and provide the payoff value for the COA measured against the criteria. Do not use bullets; remember, the paper must stand alone.

(2) Disadvantage(s). List the disadvantages for each COA and explain why they are disadvantages. Include the payoff values or how the COA measured out.

c. COA 2.

(1) Advantage. If there is only one advantage or disadvantage, list it as shown here.

(2) Disadvantage. If there is no advantage or disadvantage, state “none.”

Figure D-1. Format for a staff study (continued)

9. Comparison of the COAs.

a. After testing each COA against the stated criteria, compare the COAs to each other. Determine which COA best satisfies the criteria. Develop for the reader, in a logical, orderly manner, the rationale you use to reach the conclusion in paragraph 10 below. For example, *Cost: COA 1 cost less than COA 2, which is equal to the cost of COA 4. COA 3 has the greatest cost.*

b. You can use quantitative techniques (such as decision matrixes, select weights, and sensitivity analyses) to support your comparisons. Summarize the results of these quantitative techniques clearly so that the reader does not have to refer to an annex. *Do not explain the quantitative technique, simply state what the results are.* Remember, quantitative techniques are only tools to support the analysis and comparison. They are *not* the analysis and comparison.

10. Conclusion. Address the conclusion drawn from analyzing and comparing all the relevant factors (for example, *COA 2 is the best COA because . . .*). The conclusion must answer the problem statement. If it does not, then either the conclusion or the problem statement is incorrect.

Encl

1. Implementing document (TAB A)

2.

3.

(Signature Block)

4.

NOTE: Address supporting enclosures in the body of the study. The enclosures you produce (implementing document, decision matrixes, and so on) must comply with common format requirements (AR 25-50).

Concurrences/Nonconcurrences: (List directorates/agencies/persons with whom you must coordinate.)

Section/Agency	Concur/Nonconcur _____	Date _____
-----------------------	-------------------------------	-------------------

NOTE: Each officer must initial his/her concurrence or nonconcurrence, followed by his rank, name, position and/or title, telephone number, and E-mail address, and briefly state the reason for his nonconcurrence. This statement normally is on a separate page that will become an annex to the study.

Consideration of Nonconcurrence: The author of the study states the results of the consideration of any nonconcurrences. He either briefly states the results or attaches them as another annex. If consideration shows he cannot support the concurrence he must state the reasons. The author signs or initials the consideration of nonconcurrence(s).

Figure D-1. Format for a staff study (continued)

DECISION PAPERS

The decision paper is a staff action which the staff officer uses to discuss the purpose, recommendation, background and discussion, and impacts and coordination of staff actions. The decision paper should be brief and to the point, containing the essential elements of information for the decision maker to understand the staff action and reach a decision. After command group action is completed, such as approval or disapproval, or other action by the commanding general, ADCs, or chief of staff, the decision paper is returned to the originating staff officer for appropriate processing and action.

The decision paper is prepared in the informal memorandum format and should not exceed two pages (excluding supporting documentation). The paper is addressed to the person making the decision. Tabs are used sparingly, only to separate sections and to provide essential explanations or information. The staff officer should synthesize the facts, summarize the issues, and present feasible alternatives. Figure D-2 shows the annotated decision paper format and additional information. Figure D-3, page D-8, shows the coordination enclosure format. Figure D-4, page D-9, shows the nonconcurrency format, and Figure D-5, page D-10, the assembling and tabbing of staff actions.

The decision paper is prepared using the following seven paragraphs.

1. Paragraph 1 states: "1. For DECISION."

2. Paragraph 2 states: "2. PURPOSE." It should state clearly what decision is required. It should be stated in the infinitive form, "To determine the. . ." or "To obtain. . ."

3. Paragraph 3 is the recommendation. "3. RECOMMENDATION." This contains the specific recommendation that the staff officer believes will solve the problem. If the purpose of the decision paper is to obtain a signature, the document requiring the signature is placed under the first lettered tab. If the paper presents a solution to the problem and has implementing

documents for approval/signature, the recommendation may be two-fold (example):

"3. RECOMMENDATION.

a. That the (state recommended solution).

b. That the (title) approve and sign the implementing directive(s) found at Tab(s) ____."

Under each recommendation type:

APPROVED _____ DISAPPROVED _____
SEE ME _____

This allows the decision maker to note the action taken on each separate recommendation by initialing the line.

4. Paragraph 4 states the background and discussion. "4. BACKGROUND AND DISCUSSION." It explains the origin of the action, why the problem exists, and a summary of events in chronological form to help put the problem in perspective and provide an understanding of the alternatives and recommendation.

5. Paragraph 5 states the impact of the recommended decision. "5. IMPACT." This explains the impact on personnel, equipment, funding, environment, or stationing. State who, and to what extent, is impacted by the recommendation. If none, state "No impact."

6. Paragraph 6 states the coordination that was done. "6. COORDINATION." All coordination is accomplished prior to submission of the decision paper. Concurrence/nonconcurrency is indicated by lining through either CONCUR or NONCONCUR, signing/initialing, and dating. A STATEMENT OF NONCONCURRENCE is placed under a tab and identified as nonconcurrency in the coordination block. The proponent office will attempt to resolve the nonconcurrency. If this is not possible, a CONSIDERATION OF NONCONCURRENCE is added as a tab to the staff paper. See Figure D-4, page D-9, for an example.

7. Paragraph 7 is used for point of contact or action officer, organization, and telephone number.

Decision Paper (An informal memorandum)

ABCA-XX-XXX (Marks Number)

Date

MEMORANDUM THRU (or FOR)

FOR (If THRU is required)

SUBJECT:

1. For DECISION. (Indicate if decision is time-sensitive to an event or has a suspense to a higher head-quarters. Suspenses to the command group are not shown.)
2. PURPOSE: (Brief description of the situation requiring a decision. Keep it short. If you need more space for details, use an enclosure.)
3. RECOMMENDATION. (State a specific recommendation, for example, "That the commander approve and sign the memorandum at TAB A tasking xx Brigade with installation support detail." Designate additional implementers as TAB A1, A2, and so forth. Add a line after each separate recommendation where the approving authority may indicate action taken.)

APPROVED _____ DISAPPROVED _____ SEE ME _____

4. BACKGROUND AND DISCUSSION.
 - a. (Refer to background information at TABs E through ____.)
 - b.
 - c.
5. IMPACTS. (Indicate resource funding impact of the recommendation decision(s), if any.)
 - a. Personnel. (Refer to background information at TABs E through ____.)
 - b. Equipment.
 - c. Funding.

6. COORDINATION.

ACofS, G1/AG	CONCUR/NONCONCUR _____	CMT _____	DATE: _____
ACofS, G2	CONCUR/NONCONCUR _____	CMT _____	DATE: _____
DPTM	CONCUR/NONCONCUR _____	CMT _____	DATE: _____

Figure D-2. Format for a decision paper (continued)

ABCA-XX-XXX

SUBJECT: (The same subject as on page 1)

7. Use this paragraph for point of contact or action officer, organization, and telephone number.

X Encls

- 1. Document for Approval (TAB A)
- 2. Taskers (TAB B)
- 3. Coordination (TAB C)
- 4. Nonconcurrences (TAB D)
- 5. As Required (Tabs E through___)

SIGNATURE BLOCK

Xxxxxxxx, Xxxxx
 XXXXXXXXXXXXXXX

Figure D-2. Format for a decision paper (continued)

COORDINATION ENCLOSURE

(This is an enclosure to a Decision Paper. Coordination with staff officers/unit commanders is indicated by "CONCUR" or "NONCONCUR.")

COORDINATION

ACofS,G1/AG	CONCUR/NONCONCUR_____	CMT_____	DATE:_____
DEH	CONCUR/NONCONCUR_____	CMT_____	DATE:_____
DOL	CONCUR/NONCONCUR_____	CMT_____	DATE:_____
ACofS, G3	CONCUR/NONCONCUR_____	CMT_____	DATE:_____
DRM	CONCUR/NONCONCUR_____	CMT_____	DATE:_____

Figure D-3. Coordination enclosure to decision paper

NONCONCURRENCE ENCLOSURE

(This is an enclosure to a decision paper, if coordination enclosure indicates a nonconcurrency comment.)

STATEMENT OF NONCONCURRENCE

A statement on plain bond paper headed as above. Specifically address the points in the recommendation or document with which you disagree, offering whenever possible an alternative, constructive recommendation. The action officer receiving this nonconcurrency makes it part of the final document and adds to it a further comment below, or on a following sheet.

I. M. DEBOSS
COL, IN
XXXXXXXX, XXXXX

CONSIDERATION OF NONCONCURRENCE

Try to resolve disagreement before formal staffing. If the disagreement remains, you have two options: (1) Modify the recommendation to satisfy the nonconcurrency. In that case, you can note the compromise in this paragraph, but be sure to coordinate beforehand with the nonconcurring officer. (2) You can continue to disagree, spelling out in this paragraph your reasons for pursuing the recommendation unmodified. If you need more space, put your "consideration of nonconcurrency" on a separate page.

DON E. FOX
COL, AR
XXXXXX, XXXXX

Figure D-4. Nonconcurrency enclosure to decision paper

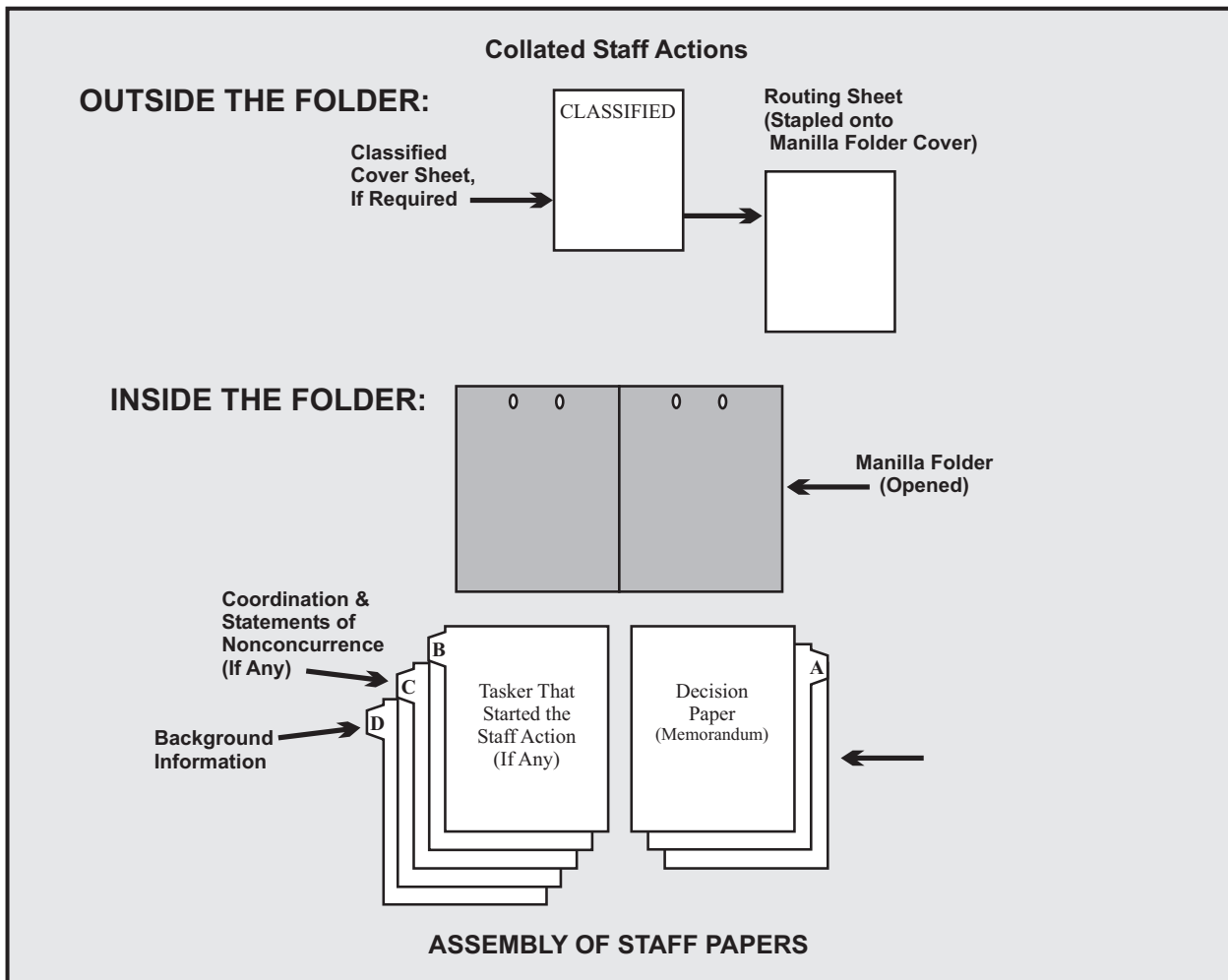

Figure D-5. Assembling and tabbing staff actions

Appendix E

MILITARY BRIEFINGS

Briefings are a means of presenting information to commanders, staffs, or other designated audiences. The techniques employed are determined by the purpose of the briefing, the desired response, and the role of the briefer. This appendix describes the types of military briefings and gives briefing formats for each type.

TYPES OF BRIEFINGS

There are four types of military briefings:

- Information.
- Decision.
- Mission.
- Staff.

Information

The information briefing is intended to inform the listener and to gain his understanding. The briefing does not include conclusions and recommendations, nor require decisions. The briefing deals primarily with facts. The briefer states that the purpose of the briefing is to provide information and that no decision is required. The briefer provides a brief introduction to define the subject and to orient the listener and then presents the information. Examples of an information briefing are information of high priority requiring immediate attention; information of a complex nature, such as complicated plans, systems, statistics, or charts, requiring detailed explanation; and controversial information requiring elaboration and explanation.

Decision

The decision briefing is intended to obtain an answer or a decision. It is the presentation of a staff officer's recommended solution resulting from analysis or study of a problem or problem area. Decision briefings vary as to formality and detail depending on the level of command and the decision maker's knowledge of the subject (the problem or problem area). In situations where the person receiving the briefing has prior knowledge of the problem and some information relating to it, the briefing normally is limited to a statement of the problem, essential background information, and a recommended solution.

However, the briefer must be prepared to present his assumptions, facts, alternative solutions, reason for choosing the recommended solution, and the coordination involved. If the person who is being briefed is unfamiliar with the problem and the facts surrounding it, then a more detailed briefing is necessary. In this case, the briefing should include any assumptions used in analyzing the problem, facts bearing on the problem, a discussion of the alternatives, the conclusions, and the coordination involved. The staff study format in Appendix D provides a logical sequence for presenting a detailed decision briefing.

At the outset of the briefing, the briefer must state that he is seeking a decision. At the conclusion of the briefing, if the briefer does not receive a decision, he asks for it. The briefer should be certain that he understands the decision thoroughly. If he is uncertain, he asks for clarification. In this regard, a precisely worded recommendation that may be used as a decision statement, once approved by the commander, assists in eliminating possible ambiguities. Following the briefing, if the chief of staff (executive officer) is not present, the briefer informs the SGS or other appropriate officer of the commander's decision.

Mission

The mission briefing is used under operational conditions to provide information, to give specific instructions, or to instill an appreciation of a mission. It is usually presented by a single briefing officer, who may be the commander, an assistant, a staff officer, or a special representative. This depends on the nature of the mission or the level of the headquarters. In an operational situation or when the mission is of a critical nature, it may become necessary to provide individuals or smaller units with more data than plans and orders provide. This may be done by means of the mission briefing. The mission briefing reinforces orders, provides more detailed requirements and instructions for each individual, and explains the significance of each individual role.

Staff

The staff briefing is intended to secure a coordinated or unified effort. This may involve the exchange of information, the announcement of decisions within a command, the issuance of directives,

or the presentation of guidance. The staff briefing may include characteristics of the information briefing, the decision briefing, and the mission briefing. Attendance at staff briefings varies with the size of the headquarters, the type of operation being conducted, and the personal desires of the commander. Generally, the commander, deputies or assistants, chief of staff (executive officer), and coordinating and special staff officers attend. Representatives from major subordinate commands may be present. The chief of staff (executive officer) usually presides over the staff briefing. He calls on staff representatives to present matters that interest those present or that require coordinated staff action. Each staff officer is prepared to brief on his area of responsibility. In garrison, staff briefings are often held on a regularly scheduled basis. In combat, staff briefings are held when required by the situation. The presentation of staff estimates culminating in a commander's decision to adopt a specific course of action is a form of staff briefing. In this type of briefing, staff officers involved follow the general pattern prescribed for the staff estimate being presented.

BRIEFING STEPS

A briefing assignment has four steps:

1. Analyze the situation. This includes analyzing the audience and the occasion by determining—

- Who is to be briefed and why?
- How much knowledge of the subject does the audience have?
- What is expected of the briefer?

Before briefing an individual the first time, the briefer should inquire as to the particular official's desires. The briefer must understand the purpose of the briefing. Is he to present facts or to make a recommendation? The purpose determines the nature of the briefing. The time allocated for a briefing will dictate the style, physical facilities, and the preparatory effort needed. The availability of physical facilities, visual aids, and draftsmen is a consideration. The briefer prepares a detailed presentation plan and coordinates with his assistants, if used. The preparatory effort is carefully scheduled. Each briefer should formulate a "briefing outline" (next page). The briefer initially estimates the deadlines for each task. He schedules facilities for practice and requests critiques.

2. Construct the briefing. The construction of the briefing will vary with its type and purpose. The analysis provides the basis for this determination. The following are the major steps in preparing a briefing:

- Collect material.
- Know the subject thoroughly.
- Isolate the key points.
- Arrange the key points in logical order.
- Provide supporting data to substantiate validity of key points.
- Select visual aids.
- Establish the wording.
- Rehearse before a knowledgeable person who can critique the briefing.

3. Deliver the briefing. A successful briefing depends on how it is presented. A confident, relaxed, forceful delivery, clearly enunciated and obviously based on full knowledge of the subject, helps convince the audience. The briefer maintains a relaxed, but military bearing. He uses natural gestures and movement, but he avoids distracting mannerisms. The briefer's delivery is characterized by conciseness, objectivity, and accuracy. He must be aware of the following:

- The basic purpose is to present the subject as directed and to ensure that it is understood by the audience.
- Brevity precludes a lengthy introduction or summary.
- Logic must be used in arriving at conclusions and recommendations.
- Interruptions and questions may occur at any point. If and when these interruptions occur, the briefer answers each question before proceeding or indicates that the questions will be answered later in the briefing. At the same time, he does not permit questions to distract him from his planned briefing. If the question will be answered later in the briefing, the briefer should make specific reference to the earlier question when he introduces the material. The briefer must be prepared to support any part of his briefing. The briefer anticipates possible questions and is prepared to answer them.

4. Follow-up. When the briefing is over, the briefer prepares a memorandum for record (MFR). This MFR should record the subject, date, time, and place of the

briefing and ranks, names, and positions of those present. The briefing's substance is concisely recorded. Recommendations and their approval, disapproval, or approval with modification are recorded as well as any instruction or directed action. This includes who is to take action. When a decision is involved and doubt exists about the decision maker's intent, the briefer

submits a draft of the MFR to him for correction before preparing it in final form. The MFR is distributed to staff sections or agencies that must act on the decisions or instructions contained in it or whose operations or plans may be influenced.

BRIEFING OUTLINE

1. Analysis of the Situation

a. Audience.

- (1) How many are there?
- (2) Nature.
 - (a) Who composes the audience? Single or multiservice? Civilians? Foreign nationals?
 - (b) Who are the ranking members?
 - (c) What are their official positions?
 - (d) Where are they assigned?
 - (e) How much professional knowledge of the subject do they have?
 - (f) Are they generalists or specialists?
 - (g) What are their interests?
 - (h) What are their personal preferences?
 - (i) What is the anticipated reaction?

b. Purpose and type.

- (1) Information briefing (to inform)?
- (2) Decision briefing (to obtain decision)?
- (3) Mission briefing (to review important details)?
- (4) Staff briefing (to exchange information)?

c. Subject.

- (1) What is the specific subject?
- (2) What is the desired coverage?
- (3) How much time will be allocated?

d. Physical facilities.

- (1) Where will the briefing be presented?
- (2) What arrangements will be required?
- (3) What are the visual aid facilities?
- (4) What are the deficiencies?
- (5) What actions are needed to overcome deficiencies?

2. Schedule of Preparatory Effort

- a. Complete analysis of the situation.
- b. Prepare preliminary outline.
- c. Determine requirements for training aids, assistants, and recorders.
- d. Edit or redraft.
- e. Schedule rehearsals (facilities, critiques).
- f. Arrange for final review by responsible authority.

3. Constructing the Briefing

- a. Collect material.
 - (1) Research.
 - (2) Become familiar with subject.
 - (3) Collect authoritative opinions and facts.
- b. Prepare first draft.
 - (1) State problem (if necessary).
 - (2) Isolate key points (facts).
 - (3) Identify courses of action.
 - (4) Analyze and compare courses of action. State advantages and disadvantages.
 - (5) Determine conclusions and recommendations.
 - (6) Prepare draft outline.
 - (7) Include visual aids.
 - (8) Fill in appropriate material.
 - (9) Review with appropriate authority.
- c. Revise first draft and edit.
 - (1) Make sure that facts are important and necessary.
 - (2) Include all necessary facts.
 - (3) Include answers to anticipated questions.
 - (4) Polish material.
- d. Plan use of visual aids.
 - (1) Check for simplicity—readability.
 - (2) Develop method for use.
- e. Practice.
 - (1) Rehearse (with assistants and visual aids).
 - (2) Polish.
 - (3) Isolate key points.

- (4) Commit outline to memory.
- (5) Develop transitions.
- (6) Use definitive words.

4. **Follow-Up**

- a. Ensure understanding.
- b. Record decision.
- c. Inform proper authorities.

Format for an Information Briefing

1. **Introduction.**

Greeting.

Address the person(s) being briefed. Identify yourself and your organization.

“Good morning, General Smith. I’m Captain Jones, the S3 of the 1st Bn 28th Artillery.”

Type and Classification of Briefing.

“This is a SECRET information briefing.”

“This is an UNCLASSIFIED decision briefing.”

Purpose and Scope.

Give the big picture first.

Explain the purpose and scope of your briefing.

“The purpose of this briefing is to bring you up to date on our battalion’s General Defense Plan.”

“I will cover the battalion’s action during the first 72 hours of a general alert.”

Outline or Procedure.

Briefly summarize the key points and your general approach.

Explain any special procedures (demonstrations, displays, or tours). “During my briefing, I’ll discuss the six phases of our plan. I’ll refer to maps of our sector, and then my assistant will bring out a sand table to show you the expected flow of battle.”

2. **Body.**

Arrange the main ideas in a logical sequence.

Use visual aids correctly to emphasize your main ideas.

Plan effective transitions from one main point to the next.

Be prepared to answer questions at any time.

3. **Closing.**

Ask for questions.

Briefly recap your main ideas and make a concluding statement.

Announce the next speaker.

Format for a Decision Briefing

1. **Introduction.**

Military greeting.

Statement of the type, classification, and purpose of the briefing.

A brief statement of the problem to be resolved.

The recommendation.

2. **Body.**

Key facts bearing upon the problem.

Pertinent facts that might influence the decision.

An objective presentation of both positive and negative facts.

Necessary assumptions made to bridge any gaps in factual data.

Courses of Action.

A discussion of the various options that can solve the problem.

Analysis.

The criteria by which you will evaluate how to solve the problem (screening and evaluation).

A discussion of each course of action's relative advantages and disadvantages.

Comparison.

Show how the courses of action rate against the evaluation criteria.

3. **Conclusion.**

Describe why the selected solution is best.

4. **Questions.**

5. **Restatement of the Recommendation** so that it only needs approval/disapproval.

6. **Request a decision.**

The Mission Briefing

1. **General.** The mission briefing is an information briefing presented under tactical or operational conditions, usually given by a single briefing officer.

2. **The Purposes of a Mission Brief.**

Give specific instructions.

The mission briefing serves to—

- Issue or elaborate on an operation order, warning order, and so forth.
- Instill a general appreciation of a mission.
- Review the key points of a forthcoming military operation.
- Ensure participants know the mission's objective, problems they may confront, and ways to overcome them.

3. **Format.**

While the mission briefing has no set format, a convenient format is the five-paragraph operation order:

1. Situation.
2. Mission.
3. Execution.
4. Service support.
5. Command and signal.

The Staff Briefing

1. **General.** The staff briefing is a form of information briefing given by a staff officer. Often it's one of a series of briefings by staff officers.
2. **Purposes of a Staff Briefing.** The staff briefing serves to—
 - Keep the commander and staff abreast of the current situation.
 - Coordinate efforts through rapid oral presentation of key data.
3. **Possible Attendees:**
 - The commander, his deputy, and chief of staff.
 - Senior representatives of his primary and special staff; commanders of his subordinate units.
4. **Common Procedures:**
 - The person who convenes the staff briefing sets the agenda.
 - The chief of staff or executive officer normally presides.
 - Each staff representative presents information on his particular area.
 - The commander usually concludes the briefing but may take an active part throughout the presentation.

Appendix F

TASK ORGANIZATION

FUNDAMENTAL CONSIDERATIONS

Task organization is the process of allocating available assets to subordinate commanders and establishing their command and support relationships. Some assets are retained under the commander's immediate control to retain flexibility to exploit opportunities. Staff estimates and course of action analysis provide information that helps the commander determine the best task organization to—

- Retain flexibility within the concept of operations.
 - Adapt to conditions imposed by factors of METT-T.
 - Create effective combined arms teams.
 - Provide mutual support between units.
 - Ensure flexibility to meet unforeseen events and support future operations.
 - Allocate resources with minimum restrictions on their employment.
 - Facilitate the commander's intent, concept, scheme of maneuver, and guidance.
 - Weight the main effort.
 - Ensure unity of command and synchronization of effort through the proper use of command and support relationships.
 - Offset limitations and maximize the potential of all forces available.
 - Exploit enemy vulnerabilities.
 - Make the best use of terrain and weather.
- Successful task organization requires understanding—
- The mission, including the higher commander's intent and concept of operations.
 - Army doctrinal tenets and tactics.
 - The battlefield framework.
 - The roles and interrelations of operating systems.
 - The status of available forces, including morale, training, and capabilities of equipment.

- Specific unit capabilities, limitations, strengths, and weaknesses.
- The risks inherent to the plan.
- Subordinate commanders' abilities, especially the ability to apply combined arms doctrine.

The commander uses the war game to identify what combat power he needs, and where, when, and how frequently he will need it. He approves or modifies the staff's task organization recommendation based on his evaluation of the factors listed above and information from estimates and COA analysis.

Formal task organization, and the change from generic to specific units, begins after COA analysis, when the commander assigns missions to subordinate commanders. He assigns tasks to subordinate headquarters and determines if subordinate headquarters have sufficient combat power, *reallocating combat power as necessary*. He then defines command and support relations for subordinate units and decides the priorities of support. The commander allocates maneuver units two levels down to commanders one level down. There may be exceptions for CS units (for example, at corps level, engineer or MP companies may be allocated to augment divisions). The commander allocates CSS units, regardless of size, as needed.

In allocating assets, the commander and staff must consider—

- The existing task organization established in an on-going operation.
 - The potential adverse effect of breaking up cohesive teams by changing the task organization.
 - The time necessary to realign the organization after receipt of the task organization.
 - The control they have over supporting units that higher headquarters provides is provisional.

In its OPORD or OPLAN, a unit must state specifically defined command and support relationships that place it under a commanding headquarters. Definitions of support or command relationships do not always cover every situation; for example, in an armored battalion that is in direct support or is under operational

control (OPCON) to a light brigade, the sustainment functions for the armored force exceed the ability of the light brigade. Specific support tasks must be listed above the accepted doctrinal definition of a command or support relationship.

COMMAND AND SUPPORT RELATIONSHIPS

Command relationships establish the degree of control and responsibility a commander has for forces operating under his control. Command relationships can be attached, operational control (OPCON), or tactical control (TACON). FM 101-5-1 defines each command relationship. Figure F-1, graphically portrays the inherent responsibilities of each command relationship. Command responsibilities, responsibilities for service support, and authority to organize or reassign component elements of a supporting force remain with the higher headquarters or parent unit unless the authorizing commander specifies otherwise.

Support relationships establish specific relationships and responsibilities between supporting and supported

units. Support relationships are established routinely as general support (GS), general support-reinforcing (GSR), reinforcing (R), and direct support (DS). FM 101-5-1 defines each of these support relationships. Figure F-1 graphically portrays the inherent responsibilities of each support relationships.

As the commander establishes a command relationship for a subordinate unit, he must also determine if the command relationship includes administrative control (ADCON) of the unit. Administrative control includes personnel management, control of resources and equipment, discipline, and other matters not included in operational missions. Administrative control is defined in FM 101-5-1. During attachment of a unit, orders normally state whether the parent unit retains administrative control of the unit. If not, the attachment orders must specifically state that the gaining unit has administrative control. For OPCON and TACON, the parent unit will retain administrative control of the unit.

ADCON is synonymous with administration and support responsibilities identified in Title 10 United States Code (USC). This is the authority necessary to fulfill military department statutory responsibilities for

RELATIONSHIPS		INHERENT RESPONSIBILITIES							
		Has Command Relationship With:	May Be Task Organized By:	Receives Logistic Support From:	Is Positioned By:	Provides Liaison:	Establishes/ Maintains Communications With:	Has Priorities Established By:	Gaining Unit Can Further Impose Command Relationships Of:
C O M M A N D	Attached	Gaining Unit	Gaining Unit	Gaining Unit	Gaining Unit	As Required By Unit to Which Attached	Unit to Which Attached	Gaining Unit	Attached, OPCON, TACON, GS, GSR, R, DS
	OPCON	Gaining Unit	Gaining Unit (Except When Involving Multi-national Forces in NATO, Then Parent Unit)	Parent Unit	Gaining Unit	As Required By Unit to Which OPCON	Parent Unit and Unit to Which OPCON	Gaining Unit	OPCON, TACON, GS, GSR, R, DS
	TACON	Gaining Unit	Parent Unit	Parent Unit	Gaining Unit (Maneuver)	As Required By Unit Having TACON	Parent Unit and Unit Having TACON	Gaining Unit	GS, GSR, R, DS
S U P P O R T	GS	Parent Unit	Parent Unit	Parent Unit	Parent Unit	As Required By Parent Unit	Parent Unit	Parent Unit	NA
	GSR	Parent Unit	Parent Unit	Parent Unit	Parent Unit	As Required By Parent Unit and Reinforced Unit	Parent Unit and Reinforced Unit	1. Parent Unit 2. Reinforced Unit	NA
	R	Parent Unit	Parent Unit	Parent Unit	Reinforced Unit	Reinforced Unit	Parent Unit and Reinforced Unit	1. Reinforced Unit 2. Parent Unit	NA
	DS	Parent Unit	Parent Unit	Parent Unit	Supported Unit	Supported Unit	Parent Unit and Supported Unit	Supported Unit	NA

Figure F-1. Command and support relationships and inherent responsibilities

administration and support. Administrative control of an Army unit cannot be transferred to a unit of another service. ADCON of an Army unit must remain in Army channels.

FORMATTING TASK ORGANIZATION

There are two methods for formatting task organization—the outline method and the matrix method (Figure F-2, page F-4 and Figure F-3, page F-5). The sequence in which units are listed is the same for both methods (shown in Figure F-4, page F-6). The CofS (XO) selects the method the staff will use for a given plan or order.

The Outline Method

The outline method of task organization is a detailed listing in the basic order or plan of the allocation of available resources to ground maneuver units. Long or complex task organizations go in Annex A. The outline method has five steps:

1. List major subordinate control headquarters in the correct sequence. If applicable, list task organization by the phases of the operation.

a. Units are grouped by command and control headquarters. Major subordinate maneuver units (for example, 1st Bde) are listed first in alphabetical or numerical order (task forces that are a major subordinate command precede brigade listings), followed by division artillery (DIVARTY), division troops, and division support command (DISCOM).

b. The order of listing units under the major subordinate headquarters is as follows:

(1) Maneuver units (task forces (teams), infantry, light infantry, mechanized, motorized, air assault, airborne, armor, aviation, cavalry: armored and air). Then in numerical order:

(2) Artillery units (firing batteries: tube (self-propelled), tube (towed), rockets, and target acquisition).

(3) CS units by size of command echelon, then numerically, and then alphabetically.

(4) CSS units by size of command echelon, then numerically, and then alphabetically.

2. Indent subordinate units two spaces under the C² headquarters to indicate that they are organic, assigned, or attached. Qualify relationships other than attached by using parenthetical terms (for example, (OPCON), (GS), (DS), (GSR:__, (R:__), and so forth). If possible, show all command and support relationships in the task organization. Place DS units below the maneuver units they support. A command or support relationship is not a mission assignment; mission assignments go in paragraph 3b or 3c of the basic OPOrd or OPLAN under organization for combat. For clarity, list subsequent command or support relationships in the task organization in parentheses following the affected unit (for example, "...on order, OPCON to 2d Brigade" is written as (o/o OPCON 2d Bde)).

3. When the effective attachment time of a nonorganic unit to another unit differs from the effective time of the OPLAN or OPOrd, enclose the effective attachment time in parentheses after the attached unit (for example, OPCON 2d Bde Ph II). List this information in either the task organization (preferred) or in paragraph 1c, but not both.

4. Give the numerical designations of units in Arabic numerals (such as 10th Corps, 1st AF, 3d Corps, 23d Armd Div). To distinguish national forces of two or more nations, insert distinguishing letters for the country between the numeric designation and the unit name (for example, 3d (GE) Corps). Use abbreviated designations for organic units in plans and orders; however, to avoid confusion, use the full designation for nonorganic units (2-607 (155, SP) FA (Corps) rather than 2-607 FA). Designate task forces by using the last name of the commander of the task force (TF WILLIAMS), a code name (TF WARRIOR), or a number (TF 47 *or* TF 1-77).

5. Group units other than major subordinate commands and units that are attached to or support major subordinate commands under a single heading which reflects that they are under the command and control of the force headquarters (for example, division control, tactical combat force (TCF), DIVARTY, DISCOM). (See Figure F-2.)

When using the outline method, subordinate commanders name the communications zone (COMMZ) either geographically or numerically. They designate CSS installations as follows:

Supply points (SUPPTs) by number, class (cl) or classes of supply, and organization or area supported (for example, SUPPT 913, CL V, 10th Corps). Do not designate two supply points by the same number.

(Classification)

(No change from oral orders)

Copy no 4 of 25 copies
 54th Mech Div
 FRANKFURT (MA7551), GERMANY
 251700A Jul 1996
 XA 33

Operation Order 20

Reference: Map, series USACGSC 50-229, EUROPE, sheet 1 (FRIEDBERG—FRANKFURT),
 edition 1974, 1:50,000

Time Zone Used Throughout the Order: ALPHA

Task Organization:	3d Bde	Div Trp
1st Bde	TF 3-82	1054 ROC
TF 3-3	3-82 Mech (-) 3	TF 3-5
3-3 Armor (-) 1	C/3-3 Armor	3-5 Armor (-) 4
C/3-82 Mech	3-78 Mech 4	C/3-81 Mech
3-77 Mech 1	3-80 Mech 5	TF 3-81
3-2 Armor 2	3-42 FA (DS)	3-81 Mech (-)
3-4 Armor 3	29th Engr Bn (DS)	C/3-5 Armor
3-40 FA (DS)	3/54 MP Co (DS)	3-441 ADA (-)
53d Engr Bn (DS)	543 FSB	54th Avn (-)
1/54 MP Co (DS)	3/54th Cml Co	54th Engr (-)
541 FSB	3/A/54th MI (DS)	C/550th Engr
1/54th Cml Co	5 GSR Tm(s)	Cbt Bn (Hv) (-)
1/A/54th MI (DS)	3/C/55 CA Bn	54th MI
10 GSR Tm(s)		54th Sig
1/4/C/55 CA Bn	201st ACR	54th Cml Co ()
	C/54th Avn (OPCON)	Co C, 55th CA Tac Spt Bn (-)
	3-23 Cav	54th MP Co (-)
2d Bde	61st FA Bde	288th PSYOP Co
3-79 Mech 2	2d Bn (155, SP), 618th FA	
3-25 Armor 5	2d Bn (155, SP), 619th FA	Discom
3-41 FA (DS)	2d Bn, 631st FA (MLRS)	544 MSB
17th Engr Bn (DS)	2d Bn, 632d FA (MLRS)	545 Avn Spt Bn
2/54 MP Co (DS)	A/3-441 ADA	54th MMC
542 FSB	TF SMITH	4/C/55 CA Bn
2/54th Cml Co	201st Engr Co	
2/A/54th MI (DS)	4/54 MP Co (DS)	
6 GSR Tm(s)		
2/C/55 CA Bn	Div Arty	
	3-43 FA	
	54th Tgt Acq Btry	

Figure F-2. The outline method of task organization

	ANNEX A (TASK ORGANIZATION) TO OPERATION ORDER							
	1st Bde	2d Bde	3d Bde	201 ACR	DIVARTY	DIV TRP	DISCOM	TCF
MVR	C/3-82 Mech		C/3-3 Armor	D/3-23 Cav		1054 ROC		TF 3-5 TF 3-81
AVN				C/54 Avn (OPCON)				
ARTY	3-40 FA (DS) 3-43 FA (R)	3-41 FA (DS)	3-42 FA (DS)	61st FA Bde				
ADA				A/3-441 ADA				
CML	1/54 Cml Co	2/54 Cml Co	3/54 Cml Co					
ENGR	53rd Engr Bn (DS)	17th Engr Bn (DS)	29th Engr Bn (DS)	201st Engr Co		54th Engr Bde		
MI	1/A/54 MI (DS) 10 GSR Tms	2/A/54 MI (DS) 6 GSR Tms	3/A/54 MI (DS) 5 GSR Tms					
MP	1/54 MP Co (DS)	2/54 MP Co (DS)	3/54 MP Co (DS)	4/54 MP Co (DS)		54th MP Co (-)		
SIG						54th Sig		
CSS	541 FSB	542 FSB	543 FSB				544 MSB 545 MSB 54th MMC	
SOF	1 Plt, Co C 55th CA TAC Spt Bn	2/C/55 CA TAC Spt Bn	3/C/55 CA TAC Spt Bn			288th PSYOP Co SOCCE 190	4/C/55 CA TAC Spt Bn	

Figure F-3. The matrix method of task organization

The Matrix Method

The matrix method of task organization is especially convenient at brigade and below. Commanders and staffs must be fully aware that matrix formats are not standardized, and that the United States has not made agreements with alliance members governing their use. Therefore, *headquarters involved in joint or multinational operations must not use matrix formats for distribution outside their headquarters.* The matrix method has several advantages:

- It displays, at a glance, command and support relationships for subordinate units and the force as a whole.
- It shows the organization for combat for CS and CSS elements.
- It makes accounting for each unit easier.
- It conserves time and eliminates redundancy by not listing organic units of a parent organization.

When using the matrix method to task-organize corps and divisions—

- List major subordinate maneuver commands along the top of the matrix. List corps or division troops in the last space on the right.

- Normally, the user would not list a division’s brigades in the maneuver space on corps orders; however, on division orders *list* attached maneuver battalions under their brigades.

- List maneuver units in the maneuver space under the gaining headquarters if they are cross-attached.

- List in the maneuver space under the gaining command the “slice” of support that comes with a task force if it is to be attached.

- Array CS units along their respective space in the columns of the appropriate headquarters.

- Specify command relationship or a support relationship on units not inherently implied as attached.

When task-organizing brigades and battalions—

- List major subordinate maneuver commands or TF designations along the top of the matrix. List brigade control or battalion control in the last space on the right.

- On brigade orders, list maneuver battalions separately down the left column in lieu of the normal

maneuver label. On battalion orders, similarly list maneuver companies.

- If no cross-attachment occurs, leave the space blank.
- If maneuver units or elements (companies or platoons) are cross-attached, list them along the line under the appropriate headquarters.

- Array CS units along their respective space in columns of the appropriate headquarters.

NOTE: Attachment is implied unless the commander specifies another command relationship or a support relationship.

LEVELS				
Corps	Division	Brigade	Battalion	Company
Divisions (note 1)	Task forces of brigade size	Task forces of battalion size	Company teams of company size	Organic platoons
Infantry	Named task forces (in alphabetical order)	Named task forces (in alphabetical order)	Named teams (in alphabetical order)	Attached platoons
Light infantry	Numbered task forces (in alphanumeric order)	Numbered task forces (in alphanumeric order)	Numbered teams (in alphanumeric order)	Company troops
Mechanized infantry	Brigades in alphanumeric order)	Battalions	Companies	Mortars
Motorized infantry	Aviation brigade	Infantry	Infantry	Air defense
Air assault	Task force of battalion size	Light Infantry	Light infantry	Military intelligence
Airborne	Named task forces (in alphabetical order)	Mechanized infantry	Mechanized infantry	Company trains (refer to note 4)
Armored	Numbered task forces (in alphanumeric order)	Air assault	Air assault	
Separate ground maneuver brigades or battalions or both (note 2)	Cavalry squadron (note 5)	Airborne	Airborne	
Aviation brigades	Division artillery	Armored	Armored	
Armored cavalry regiment	Engineer brigade or battalion (note 8)	Separate ground maneuver battalions or companies or both (refer to note 2)	Antitank	
Corps artillery	Division troops (refer to note 3)	Named teams (in alphabetical order)	Aviation company	
Corps troops (note 3)	Air defense artillery	Numbered teams (in alphanumeric order)	Cavalry troop	
Air defense artillery	Chemical	Aviation battalions (companies)	Artillery battery	
Chemical	Military police (note 7)	Cavalry squadron (troops)	Battalion troops	
Engineer brigade or group	Signal corps	Artillery brigade or battalion	Scout platoon	
Long-range surveillance company (LRSC)	Division support command (note 4)	Engineer battalion or company (note 9)	Mortar platoon	
Military intelligence		Brigade troops	Air defense artillery	
Military police		Air defense artillery	Chemical	
Signal corps (SC)		Chemical	Engineer company	
Corps support command (note 4)		Military intelligence	Military intelligence	
		Military police	Battalion trains (refer to note 4)	
		Signal corps		
		Support battalion (note 4)		

NOTES:

1. Indenting one unit under another means the indented unit is subordinate to the other unit. That is, the command relationship is either organic, assigned, or attached. If the command relationship is not organic, assigned, or attached, then the modifier will be in parentheses immediately following the affected unit, such as when a unit is OPCON to another. All indentations will be two spaces (characters) for either the outline or the matrix methods. For example—

```

1st Bde
    1st AH Co (DS)
    
```

2. List separate ground maneuver brigades, battalions, and companies in the same order as divisions are listed in the corps structure.

3. List CS units by the size of command echelon, then list them again numerically; and then alphabetically; for example, list largest units before smallest units (of the same type).

Figure F-4. Task organization sequence for OPLAN or OPORD

4. List CSS units by size of command echelon, then list them again numerically, and then alphabetically.
5. List the cavalry squadron separately when it is operating under division control.
6. Attach the bank to the military police or HCC for tactical operations center security (at the main CP).
7. Reinforced or detached (a force modifier) indicates the addition (+) of a next subordinate element or detachment (-) of the next subordinate element. The use of these symbols is limited to units of similar function having a command relationship to the higher headquarters. Symbols are always shown in parenthesis. Their use alerts commanders and staffs of significant changes to a unit's force structure. As such, they are not precise and require additional information to determine the unit's exact subelement composition. Use the symbols when adding or deleting one or more subelements of similar functions from the parent unit. For example, if C company loses one platoon to B company, designate it as C Co (-). When two units swap one or more subelements (net gain is null), they would not receive a symbol. (Do not use the (+) and (-) together. When units are swapped, a special indicator is used, as FM 101-5-1 prescribes). Another example: If the 53d Mech Div received an additional maneuver brigade (in addition to its normally associated maneuver brigades), it would be shown as 53d Mech Div (+). However, it would not show a (+) if it received an additional FA brigade (different function). In the last case, the 53d DIVARTY would show the (+)
8. List engineer battalion under division troops for light divisions with only one engineer battalion.
9. List engineer company under brigade troops when only one engineer company is task-organized to the brigade (as is done in light divisions).
10. List engineer platoon under battalion when only one engineer platoon is task-organized to the battalion (as done in light units).

Figure F-4. Task organization sequence for OPLAN or OPORD (continued)

Appendix G

REHEARSALS

A rehearsal is the act or process of practicing an action in preparation for the actual performance of that action. Rehearsing key combat actions allows participants to become familiar with the operation and to translate the relatively dry recitation of the tactical plan into visual impression. This visual impression helps them orient themselves to both their environment and to other units during the execution of the operation. Moreover, the repetition of combat tasks during the rehearsal leaves a lasting mental picture of the sequence of key actions within the operation.

Rehearsals allow subordinate units and leaders to analyze the tactical plan to ascertain its feasibility, its common sense, and the adequacy of its C² measures before it is too late. For units to be effectively and efficiently employed in combat, rehearsals need to become habitual in training. All units at every level should routinely train and practice a variety of rehearsal types and techniques. Local SOPs should identify appropriate rehearsal types and techniques and standards for their execution.

Time is the key to conducting rehearsals, and time is probably the most precious resource available to commanders and units. The time required for rehearsal varies with the complexity of the task to be rehearsed, the type and technique of rehearsal, and the level of participation. Therefore, the emphasis on rehearsals should be at the lowest level possible, using the most thorough technique possible given the time available (Figure G-1, page G-3). When time is at a premium, the staff conducts reduced rehearsals, focusing only on critical events, using the backward planning cycle.

During offensive operations, the staff should focus on the following actions in order: the assault and action on the objective, breaching operations, passage of lines, movement to the objective, then other phases of the operation as needed. During defensive operations, the staff should focus on security, battle handover, commitment of counterattack forces on the striking force, then other phases of the operation as needed. Each unit will have different critical events based on its training status and the unit commander's evaluation of training needs.

This appendix describes rehearsal types, techniques, and responsibilities. Further it provides guidelines for conducting rehearsals.

REHEARSAL TYPES

The five types of rehearsals are the confirmation brief, backbrief, combined arms rehearsal, support rehearsal, and battle drill or SOP rehearsal. Each of the five types achieves a specific result and has a specific place in the MDMP time line.

Confirmation Brief

The confirmation brief is routinely performed by a subordinate leader *immediately after* receiving any instructions, such as an OPORD, a FRAGO, and so forth. Subordinate leaders brief the higher commander on their understanding of his intent, their specific task and purpose, and the relationship between their unit's missions and the other units in the operation.

Backbrief

The backbrief is normally performed *throughout* the MDMP. This rehearsal allows the commander to clarify his intent early in the subordinates' tactical estimate procedure. It allows the higher commander to—

- Identify problems in his concept of operations.
- Identify problems in a subordinate unit commander's concept.
- Learn how subordinates intend to accomplish their mission.

Combined Arms Rehearsal

The combined arms rehearsal is normally conducted by a maneuver unit headquarters and performed *after* subordinate units have issued their OPORD. This rehearsal ensures that—

- The subordinate units' plans are synchronized with those of the other units in the organization.
- All subordinate commanders' plans will properly achieve the intent of the higher commander.

Support Rehearsal

Support rehearsals are normally performed within the framework of a single or limited number of operating systems. They are referred to by the primary operating

system being rehearsed, for example, the fire support (FS) rehearsal or the CSS rehearsal. Support rehearsals are performed *throughout* the MDMP time line. Although these rehearsals differ slightly by operating system, they achieve the same result:

- Ensure the proponents of a particular operating system that they can support the higher commander's plan and accomplish all missions assigned to them.
- Ensure that the particular operating system support plan is synchronized with the maneuver plan.

Battle Drill or SOP Rehearsals

A battle drill or SOP rehearsal ensures that all participants understand a technique or a specific set of procedures. These rehearsals are used by all echelons, but most extensively at platoon, squad, and section levels. They are performed *throughout* the MDMP time line. This type of rehearsal is not limited to published battle drills. It could be the rehearsal of a tactical operations center (TOC) shift change, an obstacle breach lane-marking SOP, or the actions a petroleum, oils, and lubricants (POL) section takes at a refuel on the move (ROM) site or in the defense of the brigade support area (BSA).

REHEARSAL TECHNIQUES

Techniques for performing rehearsals are limited only by the resourcefulness of the unit. Generally, six techniques are used: full dress, reduced force, terrain model, sketch map, map, and radio. These six techniques range from requiring extensive preparation time and resources to minimal requirements. As the techniques are listed, each successive technique takes a decreasing amount of time and resources to prepare and conduct. Each rehearsal technique provides different degrees of understanding to participants. Each has different security risks. Figure G-1 shows the rehearsal techniques relative to time, resourcing, operational security (OPSEC), participation, and understanding.

The discussion of the techniques that follows addresses these considerations:

- Time. Amount required from planning to execution.
- Multiechelon. Number of echelons that can participate in the rehearsal.

- OPSEC. Ease of the enemy to gather intelligence from the rehearsal.
- Terrain. Terrain management considerations.

Full Dress Rehearsal

The full dress rehearsal produces the most detailed understanding of the mission. It involves every soldier and system participating in the operation. If possible, units should conduct full dress rehearsal under the same conditions—weather, time of day, terrain, use of live ammunition—that the force will encounter during the actual operation. The full dress rehearsal is the most difficult to accomplish at higher command levels. A second rehearsal plan must be developed that mirrors the actual plan but fits the terrain the rehearsal is on.

Full dress rehearsal considerations are—

- Time. Full dress rehearsals are the most time-consuming of all the rehearsal techniques. The commander must not encroach on subordinate units' timetables by scheduling a full dress rehearsal at his convenience. For smaller units, company and below, the full dress rehearsal is the most effective technique for ensuring everyone in the operation understands his part of the mission being performed.
- Multiechelon. A subordinate unit can perform a full dress rehearsal as part of a larger unit's reduced force rehearsal.
- OPSEC. The movement of a large body of the force will attract attention from the enemy. Units must develop a plan to protect the rehearsal from the eyes of the enemy. One method is to develop a second plan to include graphics and radio frequencies. This must be done carefully to avoid confusing subordinates or giving the plan away if the enemy observes the rehearsal.
- Terrain. Terrain management for the full dress technique can be difficult if it is not planned into the initial array of forces. The rehearsal area must be identified, secured, cleared, and maintained throughout the rehearsal process.

Reduced Force Rehearsal

The reduced force rehearsal normally takes less resources than a full dress rehearsal because it involves only the unit's and subordinate units' key leaders. Terrain requirements can be the same as for a full dress rehearsal, but there are fewer participants. The commander first decides the level of leader involvement he desires. His

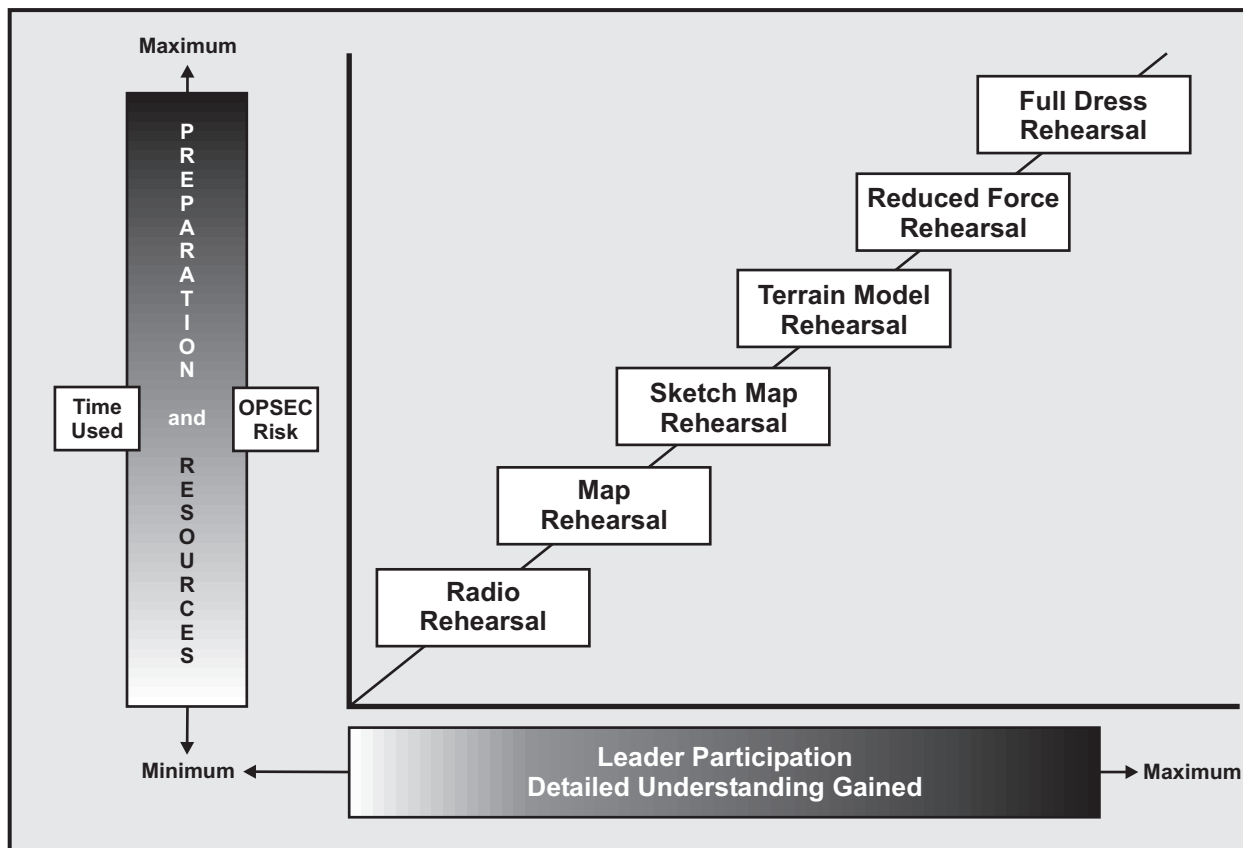

Figure G-1. Rehearsal techniques relative to time, resourcing, OPSEC, participation, and understanding

selected leaders then rehearse the plan while traversing the actual or like terrain. Commanders often use this rehearsal to rehearse the fire control measures in an engagement area during defensive operations. The reduced force rehearsal allows the leadership to rehearse the mission before moving to the full dress rehearsal. A second rehearsal plan must be developed that mirrors the actual plan but fits the terrain the rehearsal is on.

Reduced force rehearsal considerations are—

- **Time.** The reduced force rehearsal normally requires less time than the full dress technique. Again, the commander must not encroach on the timetables of subordinate units by scheduling the rehearsal at his convenience.
- **Multiechelon.** A small subordinate unit can perform a full dress rehearsal as part of a larger unit's reduced force rehearsal.
- **OPSEC.** This rehearsal is less likely to become an OPSEC problem than the full dress rehearsal because

the unit is smaller, but the number of radio transmissions stays the same as the full dress rehearsal's and remains a consideration.

- **Terrain.** Terrain management for the reduced force rehearsal can be just as difficult as for the full dress rehearsal. The rehearsal area must be identified, secured, cleared, and maintained throughout the rehearsal process.

Terrain Model Rehearsal

The terrain model rehearsal takes less time and fewer resources than the reduced force, or key leader, rehearsal, and is the most popular technique. An accurately constructed terrain model can help subordinate leaders visualize the battle in accordance with their commander's intentions. When possible, the commander should place the terrain model where it overlooks the actual terrain of the area of operations. However, if the situation requires more security, he

places the terrain model on the reverse slope of a vantage point within walking distance of a point overlooking the area of operations. The model's orientation should coincide with the actual orientation of the terrain to help participants orient to the actual area of operations. The size of the terrain model can vary from the use of icons to represent units to a large model on which the participants can walk. A large model helps reinforce the participants' perception of unit positions on the actual terrain.

Terrain model considerations are—

- Time. The most time-consuming part of the technique can be the terrain model's construction. Units must have a clear SOP stating how it will be built to ensure the model is accurate, large enough, and in sufficient detail to rehearse the mission. The SOP must also state who is to build it, and when.
- Multiechelon. Because the terrain model rehearsal takes less time than the real operation, multiechelon rehearsals are difficult.
- OPSEC. This rehearsal can become an OPSEC problem if the area around the rehearsal site is not secured. The collection of commanders and their vehicles can draw the enemy's attention. On completion of the rehearsal, the terrain model must be sanitized.
- Terrain. Terrain management is less difficult than with the previous techniques. The location of the site must be easy to find for the friendly commanders, yet invisible to the enemy. The optimum location is overlooking the terrain on which the mission will be performed.

Sketch Map Rehearsal

Units can use the sketch map technique almost anywhere, day or night. The procedures are the same as for a terrain model rehearsal, except the commander uses a sketch in place of a model. Sketches must be large enough for all participants to see as each subordinate "walks" through the interactive verbal execution of the operation. Units move symbols to represent their maneuver and location on the sketch.

Sketch map considerations are—

- OPSEC. This rehearsal, like the terrain model rehearsal, can become an OPSEC problem if it is performed outside and the area around the rehearsal site is not secured. Another concern is that the collection of

commanders and their vehicles can bring attention from the enemy.

- Terrain. The optimum location is overlooking the terrain on which the mission will be performed.

Map Rehearsal

The map rehearsal procedures are similar to the sketch map rehearsal, except the commander uses a map and operation overlay of the same scale as he used to plan and control the operation.

Map rehearsal considerations are—

- Time. The most time-consuming part is the rehearsal itself. The setup for this rehearsal is normally the easiest because it requires only maps and the current operational graphics.
- OPSEC. This technique can become an OPSEC problem if it is performed outside and the area around the rehearsal site is not secured. Another concern is that the collection of commanders and their vehicles can bring attention from the enemy.
- Terrain. The optimum location is overlooking the terrain on which the mission will be performed.

Radio Rehearsal

The commander and his staff conduct radio rehearsals by interactively and verbally executing critical portions of the operation over established communications networks. This is accomplished in a general sequence of events which the commander establishes. Because of the obvious dangers involved with using this rehearsal, only the essential, most-critical portions of the operation are rehearsed. When used, these rehearsals include all communications facilities and equipment necessary to conduct that portion of the operation. To be effective, all participants must have working communications equipment and a copy of the OPORD and overlays. The TOC can rehearse tracking the battle simultaneously.

Radio rehearsal considerations are—

- Time. This technique can be very time-consuming if the unit does not have a clear SOP for performing it, and if all units have working communications and are up on the net.
- OPSEC. This rehearsal can become an OPSEC problem because of the volume of the radio transmissions and potential compromise of information

through enemy radio monitoring. Different frequencies should be used to protect the ones to be used for the operation. The use of wire systems is an option but does not exercise the radio systems, which is the strong point of the radio rehearsal.

REHEARSAL RESPONSIBILITIES

This discussion of rehearsal responsibilities addresses planning, preparation, and execution. The discussion is developed around the combined arms rehearsal. The responsibilities do not change for support rehearsals, only the position titles; for example, the G3 (S3) becomes the security, plans, and operations officer (SPO).

Planning

The commander provides the following information as part of the commander's guidance during the initial mission analysis and re-evaluates it once he has selected a course of action:

- The type of rehearsal.
- The rehearsal technique.
- The place.
- The attendees.
- The enemy COA to be portrayed.

The CofS (XO) ensures that all rehearsals are imbedded in the unit's time management system. He is responsible for—

- Publishing the rehearsal time and location in the OPORD or in a warning order.
- Completing any rehearsals with the staff.
- Determining rehearsal products based on type, technique, and METT-T.
- Coordinating LNO attendance from adjacent units.

Preparation

The commander, ideally, prepares to rehearse the mission with events phased in proper order from start to finish. When time is short, this is not always possible. The commander—

- Identifies and prioritizes key events to be rehearsed.

- Allocates time for the events being rehearsed.
- Conducts personal preparation, to include reviews of—
 - Completeness of task organization.
 - Readiness of personnel and material.
 - Unit level of preparation for the assigned mission.

The CofS (XO), through war gaming, and coordination with the commander—

- Coordinates and allocates time for the key events requiring rehearsal.
- Establishes rehearsal time limits according to the commander's guidance and METT-T.
- Verifies rehearsal site preparation. A separate rehearsal site may be required for key rehearsal events such as an enlarged objective area or a possible obstacle site. The rehearsal site must be accurate and complete with—

- Appropriate markings and associated training aids.
- Parking areas.
- Local security.

- Determines the method for controlling the rehearsal and ensuring its logical flow. Using a script to control the rehearsal is discussed on page G-6.

Subordinate leaders complete their planning process, to include—

- Complete unit order and plans.
- Identify issues derived from the parent unit order.
- Provide copy of their unit order with graphics to the parent unit.
- Conduct personal preparation similar to that of the senior commander.

Higher headquarters—

- Must deconflict all subordinate unit graphics. These composite overlays are the first step for leaders to visualize the whole unit's plan.
- Publish composite overlays at the rehearsal, to include, at a minimum—
 - Maneuver.

- Fire Support.
- Mobility and survivability (M/S).
- CSS.

Execution

The commander must command the rehearsal, just as he will command the fight. He must maintain the focus and level of intensity, allowing absolutely no potential for subordinate confusion. Although the staff refined the plan, it belongs to the commander; he must use it to fight. The rehearsal cannot become his brief to subordinate commanders. The rehearsal's purpose is to validate synchronization—what, when, and where—of subordinate units' tasks to execute the commander's intent.

The CofS (XO) should direct the rehearsal. If the G3 (S3) is the director, the CofS (XO) will not sense the intricacies necessary to synchronize the combined arms team. The TOC then becomes a mere site for situation maps, not the proactive agent that molds the force's effects to achieve the commander's vision for success. The CofS (XO) must—

- Conduct a formal roll call and ensure that everyone brings the necessary equipment, to include unit graphics and previously issued orders, to help adjust to the rehearsal plan.
- Validate task organization for the mission. Linkups must be complete or on schedule and required material and personnel, on hand. *The importance of this simple check cannot be overemphasized.*
- Rehearse the synchronization of combat power from flank, higher, and his own units, which are often beyond communications' reach of the commander and the G3 (S3).
- Synchronize the timing and contribution of each operating system by ensuring the rehearsal of the decisive points, by time or event, that are connected to a decision. What are the conditions required to—

- Commit the reserve?
- Move a unit?
- Close or emplace an obstacle?
- Fire a specific target?
- Move a medical station, change a supply route, alert specific observation post (OP), and so on?

- Discipline leader movements, enforce brevity, and ensure completeness at the rehearsal. The OPORD, decision support template (DST), and synchronization matrix are his tools.

- Keep within established time constraints.
- Ensure that selected events receive appropriate attention.
- Ensure that absentees and flank units receive changes. Changes must be transmitted by courier or radio immediately.

The G3 (S3) assists the commander in the fight forward and should rehearse that task. He—

- Portrays his actions during the fight.
- Ensures compliance with the plan.

The G2 (S2) bases his execution actions on the enemy COA the commander selected during the planning process. The G2 (S2) must—

- Portray his best assessment of the enemy COA.
- Communicate the enemy commander's presumed concept of operation, desired effects, and intended end state.

Subordinate unit leaders, using an established format—

- Effectively articulate their units' actions and responsibilities.
- Record changes on their copies of the graphics or OPORD.

The recorder, after the rehearsal is complete—

- Restates any changes, coordination, or clarifications directed by the commander.
- Estimates the time that a written FRAGO codifying the changes will follow.

The staff updates the OPORD, the DST, and the synchronization matrix.

If the rehearsal is executed properly, leader participation should validate each leader's role as part of the whole force—what is done, when relative to time and event, and where to achieve desired effects. The rehearsal ensures that commanders have a common visualization of the enemy, their own forces, and the terrain, and the relationship between them. It identifies specific actions requiring immediate staff resolution and informs the higher commander on critical

issues or locations he or his CofS (XO) or G2 (S3) must personally oversee.

REHEARSAL SCRIPT

An effective technique for controlling the rehearsals is to use a script. It keeps the rehearsal on track and is a checklist to ensure all operating systems and outstanding issues are addressed during the rehearsal. The script has four major parts:

- The agenda.
- The response sequence.
- Actions checklist (friendly and enemy).
- Sequence of events.

The Agenda

Units must rehearse using the tools they will use when fighting the battle: the OPORD, the synchronization matrix, and the DST. These can both drive and focus the rehearsal. During fire support or CSS rehearsals, the fire support execution matrix and the logistics synchronization matrix can be used. The two products are tied directly to the corresponding level synchronization matrix and DST.

Response Sequence

The players must respond in a logical sequence. The sequence might be by operating system, or by unit as the organization is deployed from front to rear. The sequence must be determined before the rehearsal and posted at the rehearsal site.

Actions Checklist

The enemy force must be portrayed effectively and quickly without distracting from the rehearsal. A technique is to establish a sequence much like that of the friendly units, but from the enemy perspective.

Sequence of Events

The following paragraphs provide a generic sequence of events for a rehearsal. Although developed for a combined arms rehearsal, with a few modifications, this sequence can be used for FS and CSS rehearsals. This example fits brigade, task force/battalion, company/team level rehearsals and will support any rehearsal technique. The agenda's

In the predetermined sequence the players, using an established format, verbalize and act out their unit's actions at that point in time. If no action is taken then the "unit" states, "No change," meaning the unit's status has not changed since the previous event. This "acting out" continues in sequence until all the players must pay attention. *When one player finishes, the next player immediately begins without being prompted.* This facilitates a focused, timely rehearsal.

products depend on the rehearsal type. The response sequence must be determined up front and posted to keep the rehearsal moving.

Step 1. Ground Rules

- Call roll, start on time.
- Quickly review your SOP if you have new players at the rehearsal.
- Ensure a recorder is ready.
- Provide an orientation to the rehearsal product and important graphic control measures.
- Designate the rehearsal start time in relation to the operation. One event prior to the first event being rehearsed allows for proper deployment of forces.
- Ensure everyone understands the parts of the plans to be rehearsed.
- Update both friendly and enemy activities if necessary. Some units may already be executing.
- Finish on time.

Step 2. Deployment of the Enemy

Deploy the enemy on the rehearsal product as they would look just prior to the first rehearsal event. Re-stating the enemy equipment may be a waste of time by this point.

Step 3. Deployment of the Friendly

Deploy the friendly forces, including adjacent units, to the point in time the rehearsal will start. As friendly units are *initially* posted to the rehearsal product, they should state their task and purpose, task organization, and strength.

Other special units may brief their subordinate unit positions at the start time, as well as at any particular points of emphasis, to include forward arming and refueling points (FARPs), ROM, or communications checkpoints (CCPs). Restating the commander's intent may not be necessary at this point.

Step 4. Advancement of the Enemy

Begin to advance the force that has the initiative and continue in accordance with the war-gaming sequence of action, reaction, and counteraction (see page 5-22). In Step 2 the enemy was deployed up to the point the rehearsal will start; the enemy continues to maneuver from there. Depiction must be definitive, tying enemy actions to specific terrain or friendly units' actions. An accurate portrayal of the situation template developed for the staff war-gaming process must be communicated. The enemy is uncooperative, but not invincible.

Step 5. Decision Point

On completion of the enemy action, assess conditions to determine if a decision point has been reached. These are the decision points taken directly from the DST.

Not at a Decision Point. If the unit is not at a decision point, and not at the end state, the unit continues by stating the next event on the synchronization matrix and, using the predetermined sequence, continues to act out and verbalize the actions. This is represented by the right side of the synchronization matrix.

At a Decision Point. If the unit has reached a decision point, the commander, having seen the conditions being established, states his decision to continue on the current course or to select a branch. If the commander selects to stay the current course of action, the next event from the matrix is stated and the friendly units are advanced. *If a branch is selected*, the commander states why he has selected that branch, the first event of that branch is stated, and the rehearsal continues from that point until all events of that branch are rehearsed. As decisive points are reached, the XO states the conditions for success.

Step 6. Branch End State Reached

Terminate the initial phase of the rehearsal after the desired end state of the branch is achieved. In an attack, this will usually be on the objective after consolidation and casualty evacuation are complete. In the defense, this will usually be after the decisive action, such as the commitment of the reserve, and the final destruction or

withdrawal of the enemy and casualty evacuation are complete.

Step 7. Recoil

After the initial phase, "recoil" to the situation at the first decision point. State the criteria for a decision to change the plan. Assume these criteria have been met and then refight the fight from that point forward, all the way until the desired end state is attained. Complete any coordination to ensure understanding and requirements are met. Record any changes. Go to the next decision point and assume that the criteria have been met. Repeat the previous steps until all decision points and branches have been rehearsed.

Other Considerations

Small issues that arise during the rehearsal are not normally addressed immediately; instead they are recorded. This ensures the rehearsal's flow is not interrupted. If the issue still stands at the end of the rehearsal, it must be resolved. However, if the issue can wait until the end of the rehearsal, it may not have been an issue after all. If the issue is a war stopper, the staff must *stop and accomplish the coordination immediately*. This coordination is one of the key points of the rehearsals. If it is not done immediately, it will be difficult to get the word to all the players later.

Key CS and CSS items need to be part of the rehearsal, including plans for casualty evacuation, routes, ambulance exchange point locations, ROM, Class IV and V resupply points, logistics release points, displacement times and locations for the BSA, EPW collection points, aviation support, and military police actions. These items should be injected into the rehearsal at the appropriate times by the coordinating staff officer. *Summarizing these actions at the end of the rehearsal lessens the value of the rehearsal as a coordination tool.*

The staff updates the decision support matrix and provides it to each leader prior to departure. An option is to provide it prior to the rehearsal and rely on individual pen and ink changes for each update. This is the final opportunity for subordinates to identify and resolve dangling issues. The staff must ensure all coordination done at the rehearsal is clearly understood by all players and captured by the recorder. All changes to the published order are in effect verbal FRAGOs. As soon as possible, the staff should collect the verbal FRAGOs into a written change to the order.

CONDUCTING A REHEARSAL

Participants can use the following sequential guidelines during rehearsals:

1. Orient participants to the training aid and the terrain.
2. Define the standard (what the commander will accept as satisfactory performance for the rehearsal).
3. Visualize and synchronize the concept of operations. Verbally walk through the concept of operations. Subordinate commanders should interactively verbalize their units' actions, entering or leaving the discussion at the time they would expect to begin or end their tasks or activities on the battlefield. This will help the commander assess the adequacy of synchronization.
4. Focus on the key events and the synchronization required to achieve the desired effect on the enemy.
5. Consider the enemy's courses of action (using the possibilities derived from the war game during COA analysis).
6. Address any points in the operation where the execution of branches or sequels is likely to occur.
7. If the standard is not met and time permits, rehearse again.
8. For feedback, make the necessary changes to the decision support template (such as positions, synchronization, or decision point locations).

Before the Rehearsal

Once participants assemble at the rehearsal site, the rehearsal leader briefs them. The briefing must include an introduction and overview as well as an orientation.

Introduction and Overview

The commander, CofS (XO), or G3 (S3) *introduces* himself and all other participants as appropriate. He then gives an *overview* of the briefing topics, the rehearsal subjects and sequence, and the time line (specifying the no later than (NLT) ending time). He explains participation in after-action reviews, how and when they will occur, and how he will incorporate changes into the existing order. He explains, in detail, restrictions imposed on the force, such as the use of pyrotechnics, light discipline, weapons firing, or radio transmissions. He

ensures that all participants understand safety precautions and enforces their use. Last, he emphasizes results and what standards of task execution he expects.

At this time, subordinate leaders relate any results of tactical planning or rehearsals they may have already conducted. If the subordinate unit recommends a change to the existing plan, the commander, CofS (XO), or G3 (S3) acts on the recommendation before the rehearsal begins if possible. If not, the recommendation will always be resolved by a decision before the rehearsal ends.

Orientation

The rehearsal leader gives an orientation to familiarize participants with the terrain or scale model in use. He also issues supplemental materials, if appropriate. He identifies magnetic north on the terrain model or scaled terrain and points out objects and features representing actual terrain features. He also explains any graphic control symbols, obstacles, or fire support targets. The rehearsal leader always concludes the orientation with a call for questions.

During the Rehearsal

After the briefing, the rehearsal begins according to the rehearsal plan. Before the rehearsal occurs, the staff should develop the plan or order with at least the basic five paragraphs and necessary overlays. At this time, all annexes may not yet be published; however, the details should be developed. Commanders must remember that the rehearsal is not a substitute for the war game.

The commander, CofS (XO), or G3 (S3) observes and critiques all portions of the rehearsal. Critiques center on meeting the commander's intent and coordination between units. The internal execution of tasks within the rehearsal is almost always left to the subordinate unit commander's judgment and discretion. Leaders at all levels conduct periodic after-action reviews. This ensures that units rehearse tasks to acceptable levels of competence and that substandard performance is not reinforced.

After-action reports also provide an opportunity to incorporate lessons learned into the existing plan or into subsequent rehearsals. The rehearsal leader must emphasize integration of fire support, events which trigger different branch actions, and actions on contact. If units in reserve participate, they should rehearse all of their most likely branches.

Rehearsals continue until units are competent or until maximum time available expires. (Before the commander adjusts rehearsal times, he must consider how his decision will impact a subordinate commander's time plan.) Subsequent rehearsals may employ additional complexity and realism as time and the commander permit.

The commander leads the rehearsal; his staff runs it. The director of the rehearsal is the CofS (XO). As such, he rehearses his role during the operation. He ensures tasks are accomplished by the right unit at the right time and cues the commander to upcoming decisions. The CofS's (XO's) script is the synchronization matrix and the decision support template. These are the foundations for the OPORD and are recorded in chronological order. A terrain model rehearsal takes a proficient brigade from one to two hours to execute to standard. The following steps outline the process for conducting a rehearsal:

1. Start at the appointed time and conduct a formal roll call. Ensure everyone brings binoculars, maps, and necessary equipment.
2. Ensure that the CofS (XO) or the G3 (S3) orients the terrain model to the actual ground, the operations overlay, and the map. Describe and point out the overall area of operations and explain the markers used on the terrain model.
3. Brief the time line. The CofS (XO), or the G3 (S3) in lieu of the CofS, should do this. Designate the rehearsal start time. For example, have the rehearsal begin by depicting the anticipated situation one hour before departure. Set the time interval to be used to begin and track the rehearsal. For example, specify a 10-minute interval to equate to 1 hour of real time during the operation (Figure G-2).
4. Designate the recorder. This should be the G3 (S3), or his designated representative from the operations cell. Highlight the ground rules and incorporate ground rules into an SOP. The ground rules include who controls the rehearsal, who actually walks the terrain board, and when special staff officers will brief the commander. Special staff officers should brief by exception when a friendly or enemy event occurs within their operating system.
5. The G3 (S3) reads the mission statement, the commander reads his commander's intent, and the G3 (S3) lays out the friendly situation as it currently exists, using the terrain model.

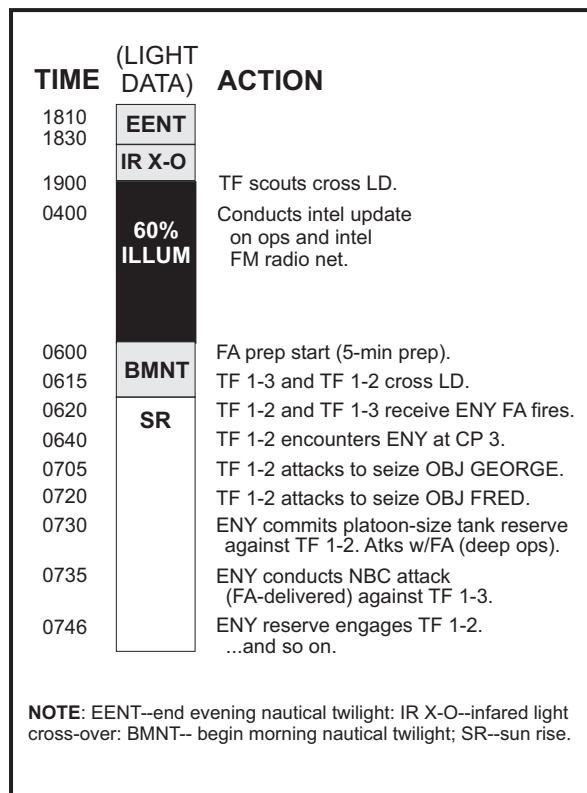

Figure G-2. Vertical time-line rehearsal technique

6. The G2 (S2) briefs the current enemy situation. He then briefs the most likely enemy course of action. (The enemy situation should already be set up on the terrain model.) The G2 (S2) also briefs the status of the reconnaissance and surveillance plan (for example, citing any patrols still out or any observation post positions or combat outposts).
7. The G3 (S3) briefs friendly maneuver unit dispositions at the rehearsal start time, including security forces. Other staff officers brief their subordinate unit positions at the start time, as well as at any particular points of emphasis. For example, the chemical officer briefs the MOPP level, and the fire support officer details the range of friendly and enemy artillery.
8. The commander gives appropriate commands. Fire support officers and FSCOORDs tell when they initiate fires, who is firing, from where, the ammunition, and the desired target effect. Commanders tell when they initiate fire in accordance with their fire support plans. The CofS (XO) talks for any staff section not present and ensures all actions on the

synchronization matrix or decision support template are addressed at the proper time or event. Everyone should avoid rewar-gaming except as absolutely necessary to ensure subordinate unit commanders understand the plan. If the staff has developed an order that addresses contingencies, they do not war-game the operation at the rehearsal site.

9. The G2 (S2) section portrays the enemy and walks the enemy through the most likely course of action (situation template), stressing reconnaissance routes, objectives, security force composition and locations, initial contact, initial fires (artillery, air, attack helicopters), probable main force objectives or engagement areas, likely chemical attack times and locations, and likely commitment of reserves. The G2 (S2) section must be specific, tying enemy actions to specific terrain or friendly unit actions. The walk-through should be an accurate portrayal of the event template.

10. Terminate the first phase of the rehearsal after achieving the desired end state (from the commander's intent). In the offense, this is usually on the objective after consolidation. In the defense, this is usually after the decisive action, such as the commitment of the reserve and the final destruction or withdrawal of the enemy.

11. When it becomes obvious that the operation requires additional coordination to ensure success, the force must immediately try to accomplish it. This coordination is one of the key points of the rehearsal. The commander and staff must ensure that coordination is understood by all participants and captured by the recorder, and that all changes to the published OPORD are in effect. However, this is not the time to make major changes. Changes are kept to only those that are vital. As soon as possible, the G3 (S3) should collect the verbal FRAGOs into a written change to the OPORD.

12. After the initial walk-through of the base order, participants need to backstep to the situation at the initial decision point. The commander should state the criteria for a decision to change the plan. The participants should assume these criteria have been met and then refight the fight from that point forward until they

attain the desired end state. They complete coordination to ensure the plan is understood and requirements are met, and record any changes.

13. Participants then go to the next decision point and ensure that the criteria for that action have been met. They then repeat step 12.

14. The staff repeats step 13 until they have rehearsed all decision points.

15. The staff briefs key CS and CSS actions. These items should be integrated into the rehearsal at the appropriate times. Summarizing these actions at the end of the rehearsal adds to the value of the rehearsal as a coordination tool.

16. After the rehearsal is complete, the recorder restates any changes, coordination, or clarifications the commander directs, and the recorder estimates how long it will take to codify changes in a written FRAGO.

17. The commander should stress any points needing additional emphasis. He should consider reiterating his intent (purpose, method, end state).

After the Rehearsal

After the rehearsal, the commander reassembles participants to conduct an after-action review. The commander reviews lessons learned and makes only the absolute minimum-required modifications to the existing plan. (Normally, these changes are effected by issuing a FRAGO.) This meeting also allows the commander to issue any last minute instructions or reminders and to reiterate his intent.

Subordinate commanders incorporate any changes the commander makes to the existing plan into their units' orders and plans. Such changes are also briefed to any key leader or unit that did not participate in the rehearsal. Changes to the plan should be refinements to that plan; they should not be radical or significant. Changes not critical to the operation's execution can confuse subordinates and desynchronize the plan.

Appendix H

PLANS AND ORDERS

This appendix explains how to construct plans and orders from battalion to corps levels. General information on the content and construction of plans and orders is followed by examples. For guidance on the preparation of orders and plans at echelons above corps, refer to JP 3-0, JP 5-03.1, and FM 100-7.

Plans and orders are the means by which the commander expresses to his subordinates his battlefield visualization, intent, and decisions, focusing on the results the commander expects to achieve—his vision of the end state of an operation. This gives subordinates the maximum operational and tactical freedom to accomplish the mission while providing only the minimum restrictions and details necessary for synchronization and coordination. Plans and orders should provide the *what* rather than the *how* to encourage initiative. Plans and orders are the method the commander uses to synchronize military actions. They also help the staff synchronize the commander's decisions and concepts. Plans and orders—

- Permit subordinate commanders to prepare supporting plans and orders.
- Implement operations derived from a higher commander's plan or order.
- Focus a subordinate's activities.
- Provide tasks and activities, constraints, and coordinating instructions necessary for the successful completion of missions.
- Do not inhibit agility, speed, and initiative in carrying out missions.
- Are communications conveying instructions in a standard, recognizable, clear, and simple format.

The amount of detail the commander provides in a plan or an order depends on the experience and competence of subordinate commanders, the cohesion and tactical experience of subordinate units, and the complexity of the operation. The commander balances these factors with his guidance and intent and determines the type of plan or order to issue. To maintain clarity and simplicity, plans and orders include annexes only when necessary and only when they pertain to the entire command. The annexes describe the additional support and

synchronization necessary to accomplish the command's assigned tasks.

All operation plans and orders—

- Have five paragraphs.
- Provide task organization and the scheme of maneuver.
- Provide a clear, concise mission statement, based on the mission assigned by the higher headquarters, that includes execution time and date.
- Convey the commander's intent and concept of operations.
- Usually include an overlay.

Included in this Appendix is a verbatim transcript of an order issued by VII Corps in World War II. It represents a typical order seen during the continuing operations of US Army forces in WWII. The brevity and simplicity of this basic order is remarkable considering that the operation involved six divisions under a corps headquarters. This simplicity and brevity was possible because of several factors. VII corps and its subordinate divisions were well trained, with detailed and practiced SOPs. They were combat-tested with experienced and cohesive staffs. Finally, there was trust up and down the chain of command. Today's units can strive for emulation of these conditions that can lead to simple and concise operation plans and orders.

NOTE: Figure H-1, page H-11, is a list of the figures in this Appendix. The figures, beginning on page H-12, contain examples and procedures for completing plans, orders, and annexes.

PLANS

A *plan* is a proposal for executing a command decision or project. It represents the command's preparation for future or anticipated operations. Because plans concern future operations and help the staff make assumptions about the nature of the situation at the time of execution, they cannot remain static. As the commander and staff change or adjust their estimates to reflect the current analysis of the situation, they must also change the plans.

The **operation plan** (OPLAN) is a plan a command uses to conduct military operations. Commanders may initiate preparation of possible operations by first issuing an OPLAN. (See Figure H-2, page H-12, and Figure H-3, page H-14.) The OPLAN—

- States critical assumptions that form the basis of the plan (in paragraph 1d of the OPLAN). Assumptions must be revalidated prior to execution of the plan.
- Becomes an OPORD when the conditions of execution occur and an execution time is determined.

A **service support plan** (SSPLAN) provides information and instructions covering an operation's service support. Estimates of the command's operational requirements are the bases for the service support plan. The SSPLAN becomes the service support order when the conditions of execution occur. (See Figure H-4, page H-20.)

Other plans are—

- The **supporting plan**, which complements another plan.
- The **contingency plan**, which provides for accomplishing different, anticipated major events before, during, and after an operation.
- The **concept plan (CONPLAN)**, which the corps uses when augmented to become a joint task force. It is an abbreviated plan, or outline, for an operation that requires considerable expansion or alteration to convert it into an OPLAN or OPORD. A CONPLAN states important features or principles of a course of action before detailed planning begins. It provides information to higher headquarters and seeks approval and allocation of resources.

ORDERS

An **order** is a written or an oral communication directing actions. Orders are based on plans or the receipt of a new mission. There are two general categories of orders—administrative and combat. **Administrative orders** cover normal administrative operations in garrison or in the field. They include general, specific, and memorandum orders; courts-martial orders; and bulletins, circulars, and other memoranda. (For details, see AR 25-30 and AR 600-8-105.) **Combat orders** pertain to strategic, operational, or tactical operations and their service support. Combat orders include *operation orders*, *service support orders*, *movement orders*, *warning*

orders, and *fragmentary orders*. This appendix is limited to combat orders.

Operation orders (OPORDs) are directives a commander issues to subordinate commanders to coordinate the execution of an operation. They always specify an execution time and date. (See Figures H-2 and H-3.)

The **service support order** (SSORD) provides the plan for service support of operations, including administrative movements (Figure H-4). It provides information to supported elements and serves as a basis for the orders of supporting commanders to their units. SSORDs may be issued either with an OPORD, or separately when the commander expects the CSS situation to apply to more than one operation plan or order. At division and corps levels of command, the SSORD may replace an OPORD's service support annex. If that happens, the staff refers to the existence of the SSORD in paragraph 4 of the OPORD. Staffs at brigade and lower levels of command may cover all necessary information in paragraph 4 of the OPORD without annexes or a separate SSORD. The SSORD follows the same format as the OPORD. It is usually in writing and may include overlays, traces, and other annexes.

The G4 (S4) has primary coordinating responsibility for preparing, publishing, and distributing the SSORD. Other staff officers, both coordinating and special, provide those parts of the order concerning their responsibilities. Their input may be a single sentence or a complete annex.

The **movement order** is a stand-alone order that facilitates an uncommitted unit's movement (Figure H-5, page H-25). The movements are typically administrative, and troops and vehicles are arranged to expedite their movement and to conserve time and energy when no enemy interference (except by air) is anticipated. Normally, these movements occur in the communications zone. The G4 (S4) has primary coordinating staff responsibility for planning and coordinating movements. However, he receives assistance from other coordinating and special staff officers (such as the G3 (S3), PM, MP, transportation officers, and movement-control personnel). The G4 (S4) is also responsible for preparing, publishing, and distributing the movement order.

However, when conducting ground movement in rear areas of the combat zone where enemy interference is expected, the movement order may become a highway regulation annex (in NATO, this is referred to as the *movement annex*) to an OPORD or SSORD. The G3 (S3) plans and coordinates these tactical movements.

The **warning order** (WARNO) is a preliminary notice of an order or action that is to follow (Figure H-6). Warning orders help subordinate units and their staffs prepare for new missions. Warning orders maximize subordinates' planning time, provide essential details of the impending operation, and detail major time-line events that accompany mission execution. The amount of detail a warning order includes depends on the information and time available when the order is issued and the information subordinate commanders need for proper planning and preparation. The words WARNING ORDER precede the message text. With the commander's (or Cof S's (XO's)) approval, a coordinating or special staff officer may issue a warning order.

The warning order clearly informs the recipient of what tasks he must do now as well as informs him of possible future tasks. However, a WARNO does not authorize execution other than planning unless specifically stated. The WARNO follows the five-paragraph field order format and may include the following information:

- Required maps (if changed from the current OPORD).
- The enemy situation and significant intelligence events.
- The higher headquarters' mission.
- Mission or tasks of the issuing headquarters.
- The commander's intent statement (when available).
- Orders for preliminary action, including reconnaissance and surveillance.
- Coordinating instructions (estimated time lines, orders group meeting, time to issue order).
- Service support instructions, any special equipment necessary, regrouping of transport, or preliminary movement of units.

Every warning order involving movement should state a time before which there is no movement. This means that a further order must be issued before that time giving actual movement time tables, or extending the period before which there will be no movement.

The **fragmentary order** (FRAGO) provides timely changes of existing orders to subordinate and supporting commanders while providing notification to higher and adjacent commands. Commanders may authorize members of their staff to change existing orders by issuing

FRAGOs in their name. A FRAGO is either oral or written and addresses only those parts of the original OPORD that have changed. The sequence of the OPORD is used and *all five-paragraph headings must be used*. After each heading, state either "No Change" or the new information. This ensures that recipients know they have received the entire FRAGO (especially if the FRAGO is sent over the radio). (See Figure H-7, page H-29.)

The FRAGO differs from an OPORD only in the degree of detail provided. It refers to previous orders and provides brief and specific instructions. The higher headquarters issues a new OPORD when there is a complete change of the tactical situation or when many changes make the current order ineffective.

CHARACTERISTICS OF OPLANS AND OPORDS

Characteristics of good OPLANs or OPORDs include—

- Addressing of critical facts and assumptions. The commander and staff evaluate all facts and assumptions. They retain for future reassessment only those facts and assumptions that directly affect an operation's success or failure. OPORDs do not state assumptions.
- Authoritative expression. The plan or order reflects the commander's intention and will. Therefore, its language must be direct. It must unmistakably state what the commander wants subordinate commands to do.
- Positive expression. State plans and orders affirmatively. "The trains will remain in the assembly area" instead of "The trains will not accompany the unit."
- Avoiding of unqualified directives. Do not use meaningless expressions like *as soon as possible*. Indecisive, vague, and ambiguous language leads to uncertainty and lack of confidence. For example, do not use "try to retain"; instead say "retain until." Avoid using phrases like "violently attacks" or "delays while maintaining enemy contact." Use "attacks" or "delays." Army doctrine already requires attacking violently and maintaining enemy contact during delays.
- Balance. Provide a balance between centralization and decentralization. The commander determines the appropriate balance for a given operation by using METT-T. During the chaos of battle, it is essential

decentralize decision authority to the lowest practical level. Over-centralization slows action and contributes to loss of initiative. However, decentralization can cause loss of precision. The commander must constantly balance competing risks while recognizing that loss of precision is usually preferable to inaction.

- **Simplicity.** Reduce all essential elements to their simplest form, eliminating elements not essential to mission success. Simplicity reduces possibilities for misunderstanding.

- **Brevity.** Be concise, clear and to the point, and include only necessary details using short words, sentences, and paragraphs. *Orders and plans, and their annexes, appendixes, tabs, and enclosures, do not include matters covered in SOPs.* However, where appropriate, they should refer to the SOP.

- **Clarity.** Eliminate every opportunity for misunderstanding the commander's exact, intended meaning. Everyone using the plan or order must readily understand it. Do not use jargon, although acronyms may be used when they do not reduce clarity. Keep the plan or order simple, using doctrinal terms and graphics.

- **Completeness.** Portray the commander's will and provide the necessary information required for execution. Provide control measures that are complete and understandable, and that maximize the subordinate commander's initiative. Provide adequate control means (headquarters and communications), clearly establish command and support relationships, and fix responsibilities to carry out the plan according to the commander's intent.

- **Coordination.** Provide for direct contact among subordinates; fit together all combat power elements for synchronized, decisive action; impose only necessary and doctrinally correct control measures; and help identify and provide for mutual support requirements while minimizing the force's exposure to fratricide.

- **Flexibility.** Leave room for adjustments that unexpected operating conditions might cause. The best plan provides for the most flexibility.

- **Clear, concise mission and intent statements and essential tasks to subordinates.**

- **Centralized planning.** The commander's mission, intent, and concept of operations underlie all plans and orders. Subordinate and supporting commanders develop plans and orders that support their commander's

plan or order. The commander's control over subordinate commanders enhances synchronization and minimizes exposure to fratricide.

- **Decentralized execution.** The commander delegates authority to subordinate and supporting commanders to execute the plan by telling them what he wants done, not how to do it. He expects subordinates to seize and retain the initiative by aggressively and creatively executing his plan. In turn, subordinate and supporting commanders ensure their plans and orders provide for decentralized execution at the next lower echelon, allowing their subordinates to seize opportunities while the higher commander reviews courses of action to exploit success.

- **Use of existing resources for decisive action.** Use all resources organic to the organization and available from higher headquarters. Provide subordinates with sufficient resources to accomplish their missions. Provide for adequate resources (personnel, material, C², liaison, and so on) for the expected duration of the contemplated operation.

- **Timeliness.** Send plans and orders to subordinates in time to allow them to adequately plan and prepare their own actions. When time is short, accept less than optimum products in the interest of timeliness. General George S. Patton, Jr., said, "A good plan violently executed now is better than a perfect plan next week."

TECHNIQUES FOR ISSUING ORDERS

There are several techniques for issuing orders. They can be oral, written, or electronically produced, using matrixes or overlays. Five-paragraph *written orders* are the standard format for issuing combat orders. Orders may be generated and disseminated via *electronic* means to reduce the amount of time necessary to gather and brief the orders group. When available preparation time or resources are constrained, the commander may use the *matrix* method of issuing an order.

The *overlay order* combines the five-paragraph order with the operation overlay. The commander may issue the overlay order when planning preparation time is severely constrained and he must get the order to subordinate commanders by the most expeditious means. He may issue the overlay order by any suitable graphic method. The overlay order may consist of more than one overlay. A separate overlay or written annex can

contain the service support coordination and organizations. (See Figure H-8, page H-30.)

Oral orders are used when operating in an extremely time-constrained environment. They offer the advantage of orders being passed quickly to subordinates but at the risk of critical information being overlooked or misunderstood in the haste of circumstances. Oral orders are most often used for FRAGOs.

Plans and orders generally include both text and graphics. Graphics convey information and instructions through military symbols. (See FM 101-5-1.) They complement the written portion of a plan or an order and promote clarity, accuracy, and brevity. The Army prefers depicting information and instructions graphically when possible. However, the mission statement and the commander's intent must be in writing.

An overlay graphically portrays the location, size, and activity (past, current, or planned) of depicted units more consistently and accurately than can text alone. An overlay enhances a viewer's ability to analyze the relationships of units and terrain. A trained viewer can attain a vision of a situation, as well as insight into the identification of implied tasks, relationships, and coordination requirements, that the written plan or order may not list or readily explain. Overlay graphics may be used on stand-alone overlays or overprinted maps in annexes, appendixes, tabs, and enclosures. The issuing headquarters is responsible for the location accuracy of coordinating points, boundaries, and other control measures, transposing graphics to and from the map scale used by subordinate headquarters. (See Figure H-8.)

ADMINISTRATIVE INSTRUCTIONS FOR PREPARING PLANS AND ORDERS

The following information pertains to all plans and orders. Unless otherwise stated, the term order is used to mean both plans and orders during the discussion. Figures H-2 and H-3 show *annotated formats for orders* having prescribed formats. Figure H-9, page H-34, is a sequential list of annexes and appendixes. Figure H-10, page H-36, shows a *common annotated annex format*. The remaining figures show *annotated formats for annexes, appendixes, and tabs* having prescribed formats.

General Information

Show all paragraph headings on written orders. There is no need to place an entry under each heading, except for, Mission, paragraph 2, and Commander's Intent, paragraph 3. A paragraph heading with no text will state: "None," "See Annex __," or "See Overlay." Conventions such as the bold font and changes in the font size appearing in the headings of annotated formats are solely for emphasis within this manual. They are not intended to be followed in actual plans or orders.

Abbreviations

Use abbreviations to save time and space if they will not cause confusion. Do not sacrifice clarity for brevity. Keep abbreviations consistent throughout any order and its annexes. Avoid using abbreviations in any joint or combined communications, except those contained in international agreements.

NOTE: FM 101-5-1 and AR 310-50 contain guidance for using operational abbreviations.

Place and Direction Designations

Describe locations or points on the ground by—

- Referring to military grid reference system coordinates.
- Referring to longitude and latitude (if the maps available do not have the military grid reference system (MGRS)).
- Giving the distance and direction from a simple reference point (for example, crossroads 1,000 meters southwest of church tower of NAPEIRVILLE LB6448).

Designate directions in one of three ways:

- By using two locations or places (for example, direction ECKENTAL PV6690—PEGNITZ PA6851).
- As a point of the compass (for example, north or northeast).
- As a magnetic, grid, or true bearing, stating the unit of measure (for example, a magnetic bearing of 85 degrees).

When a place or feature on a map is mentioned for the first time in an order, print the name in capital letters exactly as spelled on the map and show its grid coordinates in parenthesis after it. When a control measure such as a contact point or supply point is used for the first time in an order, print the name or designation of the point

followed by its grid coordinates in parenthesis. Use four-, six-, or eight-digit MGRS coordinates (as necessary to precisely locate the place, feature, or point) preceded by the 100-kilometer square designation (for example, LB6448). Thereafter, use names, planning names, or codes and repeat the coordinates only for clarity.

Describe areas by naming the northernmost (12 o'clock) point first and the remaining points in clockwise order. Describe positions from left to right and from front to rear, facing the enemy. To avoid confusion, use compass points to describe flanks, rather than right or left of the friendly force.

Always add compass points for clarity when describing a route if the possibility of confusion exists (for example, "The route is northwest along the road LAPRAIRIE-DELSON"). If a particular route already has a planning name (such as MSR LAME DOG), refer to the route using only that designator.

Designate trails, roads, and railroads by the names of the places near their locations. If you do not use place names, use grid coordinates. Precede place names with trail, road, or railroad (for example, road GRANT—CODY). To be consistent with planned movement, designate the route by naming a sequence of grid coordinates along the direction of movement. When there is no movement, name the sequence of points from left to right or front to rear, facing the enemy.

Describe river banks using the cardinal points of the compass or as either near or far in crossing operations.

Describe boundaries and phase lines by easily distinguishable terrain features (from the ground or air or on a map). When designating boundaries between units, state specifically which unit has responsibility and authority for the place, feature, or location to which the description refers. State each location along a boundary as either inclusive or exclusive to a unit (for example, 1st Bde, exclusive crossroad LB621352). List boundaries and phase lines in the order from left to right or front to rear, facing the enemy.

Naming Conventions

Planners must decide on a method to name control measures, routes, assembly areas, and so on. Unit SOPs normally designate naming conventions. For the sake of *clarity* avoid using multiword names, such as Junction City. Simple names are better than complex ones. To

ensure *operations security*, avoid assigning names that could reveal unit identities, such as the commander's name or the unit's home station. Do not name sequential phase lines and objectives in alphabetical order. For *memory aids*, use sets of names designated by the type of control measure or subordinate unit. For example, the division might use colors for objective names and minerals for phase line names.

Classification Markings and Procedures

Army Regulation 380-5 contains a detailed description of marking, transmitting procedures, and other classification instructions. Place classification markings at the top and bottom of each page. All paragraphs must have the appropriate classification marking immediately following the numbered designation of the paragraph (preceding the first word if the paragraph is not numbered). Mark unclassified instructional or training material representing orders "_____ for Training, Otherwise Unclassified," with the exercise classification level in the blank. If the entire plan or order is unclassified, no classification markings are required.

When the issuing headquarters sends classified plans or annexes separately, it assigns copy numbers to each and keeps a record of the specific copy or copies sent to each addressee (to facilitate security control).

Annotating Unnamed Dates and Times

In OPLANs or OPORDs, use one of six letters to designate unnamed dates:

- C-day. The day when a deployment operation begins. The deployment may be of troops, cargo, and/or weapons systems, using any type of transport.
- D-day. The day when an operation begins.
- E-day. The day when a NATO exercise begins.
- K-day. The day when a convoy system on a particular convoy lane begins.
- M-day. The day when full mobilization begins.
- S-day. The day (if it is not M-day) when the first mobilization manpower action occurs.

The specific hour on D-day at which a particular operation will begin is H-hour. The highest headquarters planning an operation specifies the exact meaning of D-day and H-hour. If a single plan mentions more than one such event, key the secondary event to the primary event by adding or subtracting days. Refer to days

preceding or following D-day by using a plus or minus sign and an Arabic number following the letter (for example, D-3 is three days before D-day; D+7 is seven days after D-day). When using a time element other than days, spell it out (for example, D+3 months). Refer to hours preceding or following H-hour by a plus or minus sign and an Arabic number following the letter (for example, H-3 is three hours before H-hour; H+7 is seven hours after H-hour). When using a time element other than hours, spell it out (for example, H+30 minutes).

Retain the letter designation used in the original order in translations of OPORDs. Use J only when translating documents to and from French. Use only A, B, N, S, W, and X if other letters are needed; all other letters have multinational meanings.

Where it is necessary to identify a particular operation or exercise, place a nickname, or code words if applicable, before the letter; for example, BALD EAGLE (E-day) or ANVIL EXPRESS (M-day).

Annotating Time

The effective time for implementing the plan or order is the same as the date-time group (DTG). If the effective time of any portion of the order differs from that of the order, explicitly identify this variance at the beginning of the coordination instructions (“Effective only for planning on receipt” or “Task organization effective DTG.”)

Include the time zone suffix in the heading data and in the mission statement. The time zone remains the same throughout the order. If local time is chosen, select the appropriate time zone suffix which adjusts for the difference from ZULU time. Many temperate regions practice daylight savings time. For example, Central Standard Time in CONUS uses SIERRA suffix for local time. When daylight savings time is in effect, the local time is ROMEO suffix. The relationship of local time to ZULU, not the geographical location, determines the appropriate time zone suffix.

Express dates in the sequence day, month, and year (6 August 19XX). When using inclusive dates, express them by stating both dates separated by a dash (6-9 August 19XX or 6 August-6 September 19XX). Express times in the 24-hour clock system by means of four-digit Arabic numbers. Include the time zone suffix.

Express the date and time as a six-digit date-time group. The first two digits indicate the day of the month; the last four digits indicate the time. Add the month or

the month and year to the DTG when necessary to avoid confusion. For example, a complete DTG would appear as 060140Z August 19XX.

Identification of Succeeding Pages of the Plan or Order

On pages following the first page, use a short title identification heading. Include the number (or letter) designation and headquarters (for example, OPLAN 7—23d Armd Div or ANX B (INTEL) to OPLAN 15—23d Armd Div).

Page Numbering

Number pages consecutively beginning on the first page. Number second and succeeding pages with Arabic numbers. Use letters and Roman numerals alternately to further identify annexes, appendixes, tabs, enclosures, and additions, in order. Use dashes to separate the alphabetical and Roman numeral groups that precede the Arabic page numbers of annexes, appendixes, and so forth. For example, the designation of the third page of enclosure 7 to tab B to appendix 2 to annex A is A-II-B-VII-3.

Annexes, Appendixes, Tabs, Enclosures

Annexes provide details not readily incorporated into the basic order and help keep the order's basic text short. They should increase the clarity and usefulness of the basic order by providing combat support, combat service support, and administrative details and instructions that amplify the basic order. They are a component to an order but not required if deemed unnecessary; each annex relates to a specific aspect of the operation. The number and type of annexes depend on the commander, level of command, and needs of the particular operation. Make every effort to minimize their number. They are referenced in the body of the order and listed under the heading “annexes” at the end of the order. The sequence for the most common annexes are shown in Figure H-9, page H-34. This sequence is required for all OPORDs and OPLANs. Units that do not require a particular annex indicate this by stating “Annex __ omitted.” Additional annexes needed for local command requirements will use the next letter, W, continuing through X, Y, Z, AA, AB, AC, and so forth, as needed.

When an annex that is integral to the basic order has the same distribution as the order, identify it by its title and headquarters (for example, Annex B (Intelligence) to Operation Order 10—52d Mech Div). If an annex has wider distribution than the basic order, or when issuing

an annex separately, give it a heading and title and include all final entries (acknowledgment instructions, the commander's signature, and so on).

Appendixes contain information necessary to expand an annex, *tabs* expand appendixes, and *enclosures* expand tabs. An annex, an appendix, a tab, or an enclosure may be a written text, a matrix, a trace, an overlay, an overprinted map, a sketch, a plan, a graph, or a table. Where appropriate, use the five-paragraph field order format for these documents. The staff officer with responsibility for the activity or service covered in the annex, appendix, tab, or enclosure prepares the document.

Annexes, appendixes, tabs, and enclosures are designated sequentially within their parent document, either alphabetically or numerically. They include a title in parenthesis and always reference the parent document to which they belong. *Annexes* are designated by capital letters (Annex H (Signal) to Operation Order 6—52 Mech Div), *appendixes* with Arabic numbers (Appendix 5 (Messenger Service) to Annex H (Signal) to Operation Order 6—52d Mech Div), *tabs* with capital letters (Tab A (Ground Messenger Service) to Appendix 5 (Messenger Service) to Annex H (Signal) to Operation Order 6—52d Mech Div), and *enclosures* with Arabic numbers (Enclosure 1 (Route Map) to Tab A (Ground Messenger Service) to Appendix 5 (Messenger Service) to Annex H (Signal) to Operation Order 6—52d Mech Div).

Identify additions necessary for expanding enclosures by repeating the procedures for tabs and enclosures. Use double letters (AA) or hyphenated double numbers (1-1) (for example, Enclosure 1-1 (***) to Tab AA (***) to Enclosure 1 (Route Map) to Tab A (Ground Messenger Service) to Appendix 5 (Messenger Service) to Annex H (Signal) to Operation Order 6—52d Mech Div).

Refer to annexes, appendixes, tabs, and enclosures in the body of the parent document by letter or number and title. Also list them at the bottom of the parent document under the appropriate heading.

STANDING OPERATING PROCEDURES

Standing operating procedures (SOP) detail how forces will execute unit-specific techniques and procedures that commanders standardize to enhance effectiveness and flexibility. Commanders use SOP to standardize routine or recurring actions not needing their personal involvement. They develop SOP from doctrinal sources, applicable portions of the higher

headquarters' published procedures, the commander's guidance, and techniques and procedures developed through experience. The SOP must be as complete as possible so that new arrivals or newly attached units can quickly become familiar with the unit's normal routine. In general, SOP apply until commanders change them to meet altered conditions or practices. The benefits of SOP include—

- Simplified, brief combat orders.
- Enhanced understanding and teamwork among commanders, staffs, and troops.
- Established synchronized staff drills.
- Established abbreviated or accelerated decision-making techniques.

The operations officer is responsible for preparing, coordinating, authenticating, publishing, and distributing the command's tactical and administrative SOP, with input from other staff sections.

MATRIXES AND TEMPLATES

A number of staff tools exist to support the commander and his staff in the decision-making process and the development of the order. Tools include the decision support template (DST), synchronization matrix, and execution matrix. However, matrixes and templates are only tools; they are not orders.

The *decision support template* is created by the commander and staff during the decision-making process. A DST graphically represents the projected situation, identifying where a decision must be made to initiate a specific activity or event. It does not dictate decisions; it indicates when and where the need for a decision is most likely to occur.

The staff uses the operations map as the base. Before the war gaming, the staff graphically portrays enemy COAs on the situation templates. After the war game, the staff combines projected enemy and friendly situations (developed during war gaming) with options (such as branch plans) that the commander might employ onto a DST. The DST is also keyed to the synchronization matrix (developed during war gaming). It graphically integrates—

- Time-phased lines (TPLs) and enemy events, activities, and targets.

- Friendly events, activities, scheme of maneuver, and control measures from the synchronization matrix and operation overlay.
- Commander's critical information requirements (CCIR).
- Time estimates (calculations of the times required to implement decisions).

NOTE: FM 34-1 and FM 34-130 contain discussions on the elements of the DST.

The DST supports decisions that are closely linked to other events. These decisions can involve specific targets or other actions that support the commander's concept of operations. Based on the action, reaction, counteraction drill used during war gaming, a DST lists options that should help the unit accomplish the mission. For example, a DST can provide the options for friendly maneuver and fires to counteract enemy reactions to the friendly unit's actions. Additionally, it can support CS- and CSS-related decisions. Examples include the following:

- When the enemy arrives at a certain point, the commander may decide to shift unit positions and displace the division support area.
- When a friendly unit reaches a certain point on the battlefield, the commander may decide to move supporting artillery.

A DST equates time to specific points, areas, or lines in the area of operations. Time is expressed in minutes, hours, or days in relationship to the start of the mission or as a sequence of critical events or activities. The time to accomplish certain actions for both friendly and enemy units is estimated based on set planning factors.

A DST uses NAIs and TPLs to depict specific information requirements. Decision points (DPs) integrate NAIs and CCIR by placing a DP on the projected enemy location where the commander expects to review planned options and make a decision. The TAIs depict engagement points or areas where interdiction of an enemy force will reduce or eliminate particular enemy capabilities or cause him to abandon, modify, or adopt another course of action.

The NAI is a point or area where enemy activity (or inactivity) confirms or denies a particular enemy course of action. It can be a specific point on the ground, a portion of a route, or a larger area. When possible, NAIs are placed in numbered sequences along an avenue of approach or a mobility corridor. This technique helps

calculate movement times between NAIs and limits confusion about the avenue or corridor involved.

Time-phased lines help track enemy movements. They provide a graphic means of comparing the enemy's rate of movement along different avenues of approach and mobility corridors. Time-phased lines can be computed for all types of enemy movement and operations—air assault, deliberate attack, dismounted infiltration, and so forth. Both friendly and enemy movement rates should be adjusted to compensate for the effects of weather, terrain, and obstacles. During actual operations, the G2 (S2) adjusts TPLs to conform to the enemy's actual rates of movement.

Decision points must be supported by NAIs (where an asset can detect the enemy). The commander can decide to execute a planned decision based on enemy actions at a DP. If the commander does not make a decision before the enemy force passes the DP, that option is negated. Factors affecting DP placement include the time required—

- For the G2 (S2) to receive the information from the intelligence collection or reconnaissance and surveillance asset.
- To process or analyze the information.
- To advise the commander of the activity.
- To disseminate orders or instructions to the proper maneuver, FS, CS, or CSS unit or asset.
- For the unit or asset to execute the orders or instructions.

A TAI is an area or a point along a mobility corridor or an engagement area where the commander wants to mass combat power through maneuver, fires, obstacles, and or EW. The G3 (S3) develops TAIs based on the commander's intent and in coordination with the G2 (S2), FSCoord or FSO, and the electronic warfare officer. DPs often trigger maneuver, fires, or EW on a TAI. For some TAIs, the commander specifies one definite attack option, thus one DP. However, several DPs, called a DP cluster, can be designated to address several options for one TAI. Regardless of location, DPs and TAIs must be under surveillance.

The *synchronization matrix* provides a highly visible, clear method for ensuring that planners address all operating systems when they are developing courses of action and recording the results of war gaming. The matrix clearly shows the relationships between activities, units, support functions, and key events. The

synchronization matrix supports the staff in adjusting activities based on the commander's guidance and intent and the enemy's most likely course of action. The synchronization matrix is not a formal part of plans and orders. It serves as a planning tool, an internal staff product, which normally is not distributed formally to subordinate and higher headquarters. (See Figure 5-9, page 5-20.)

When used together, the synchronization matrix and the DST form a powerful graphic C^2 tool. Once a decision is made on the COA, the staff can use the

DST and synchronization matrix to assist in writing the OPLAN or OPORD. Because missions and decisions are laid out in a logical and orderly fashion, this is also a good way to ensure nothing is left out of the OPLAN or OPORD.

The staff can write an annex to the OPLAN or OPORD as an *execution matrix*. An execution matrix depicts when and where specific supporting actions must occur.

EXAMPLES AND PROCEDURES FOR COMPLETING PLANS, ORDERS, AND ANNEXES

All plans, orders, annexes, and appendixes use the five-paragraph field order format as in Figure H-2, page H-12. Use the annotated annex format as the base guide, and refer to individual annex examples for functional-area specifics. Appendixes to annexes further supplement or explain specific requirements or detail.

In the examples that follow, bold-face paragraph numbers, letters, and titles denote normal paragraph headings. Bulleted lists (using • format) indicate suggestions of the kinds of items that may go in subparagraphs. Figure H-1 is a list of the figures used to explain or validate the construction of plans, orders, and annexes.

		Page
Figure H-1.	List of figures	H-11
Figure H-2.	OPLAN or OPORD outline format	H-12
Figure H-3.	Annotated OPLAN or OPORD format	H-14
Figure H-4.	Annotated service support plan (order) format.	H-20
Figure H-5.	Movement order format	H-25
Figure H-6.	Warning order (WARNO) format.	H-27
Figure H-7.	Fragmentary order (FRAGO) format.	H-29
Figure H-8.	Overlay order format.	H-30
Figure H-9.	Sequence of annexes and appendixes to OPLANs or OPORDs	H-34
Figure H-10.	Annex and appendix format (general)	H-35
Figure H-11.	Annex A (Task Organization) instructions and format	H-38
Figure H-12.	Annex B (Intelligence) instructions and format.	H-39
Figure H-13.	Annex C (Operation Overlay) instructions and format	H-41
Figure H-14.	Annex D (Fire Support) instructions and format	H-42
Figure H-15.	Annex E (Rules of Engagement) instructions and format	H-45
Figure H-16.	Annex F (Engineer) instructions and format	H-46
Figure H-17.	Annex G (Air Defense) instructions and format	H-49
Figure H-18.	Annex H (Signal) instructions and format	H-51
Figure H-19.	Annex I (Service Support) instructions and format.	H-53
Figure H-20.	Annex J (Nuclear, Biological and Chemical (NBC) Operations) instructions and format	H-56
Figure H-21.	Annex K (Provost Marshal) instructions and format	H-58
Figure H-22.	Annex L (Reconnaissance and Surveillance) instructions and format.	H-60
Figure H-23.	Annex M (Deep Operations) instructions and format	H-61
Figure H-24.	Annex N (Rear Operations) instructions and format	H-62
Figure H-25.	Annex O (Airspace Command and Control) instructions and format	H-63
Figure H-26.	Annex P (Command and Control Warfare) instructions and format	H-64
Figure H-27.	Annex Q (Operations Security (OPSEC)) instructions and format.	H-66
Figure H-28.	Annex R (Psychological Operations (PSYOP)) instructions and format	H-67
Figure H-29.	Annex S (Deception) instructions and format	H-69
Figure H-30.	Annex T (Electronic Warfare) instructions and format	H-70
Figure H-31.	Annex U (Civil-Military Operations) instructions and format	H-71
Figure H-32.	Annex V (Public Affairs) instructions and format.	H-72
Figure H-33.	VII Corps Operation Order (WWII)	H-74

Figure H-1. List of figures

(Classification)

Place the classification at the top and bottom of every page of the OPLAN or OPORD.

(Change from oral orders, if any)

This statement is applicable only if an oral order is issued by the commander. The phrases “No change from oral orders” or “No change from oral orders except paragraph _” are necessary.

Copy __ of __ copies
Issuing headquarters
Place of issue (coordinates)
Date-time group of signature

Show the place of issue (location of issuing headquarters) on each copy. Show the name of the town or place in capital letters, coordinates in parentheses, and the country in capital letters. You may encode both.

The effective time for implementing the plan or order is the same as the date-time group (DTG) unless coordinating instructions state otherwise. Use time zone ZULU (Z) unless the order states otherwise. When orders apply to units in different time zones, use ZULU time zone. In operation and service support plans and orders, list the time zone applicable to the operation in the heading of the order following the references. When an order or plan does not specify the actual date and hour for beginning an operation, apply the proper reference designations.

Message reference number

Message reference numbers are internal control numbers that the unit signal officer issues and assigns to all plans and orders. The unit's SOP normally describes the number's allocation and use. Using the number allows an addressee to acknowledge receiving the message in the clear.

OPERATION PLAN (ORDER) _____ (code name)
(number)

Plans and orders normally contain a code name and are numbered consecutively within a calendar year.

References: The heading of the plan or order includes a list of maps, charts, datum, or other related documents the unit will need to understand the plan or order. The user does not need to reference the SOP, but may refer to it in the body of the plan or order. The user references a map using the map series number (and country or geographic area, if required), sheet number and name, edition, and scale, if required. Datum is the mathematical model of the earth used to calculate the coordinate on any map. Different nations use different datums for printing coordinates on their maps. The datum is usually referenced in the marginal information of each map.

Time Zone Used Throughout the Plan (Order): The time zone used throughout the order (including annexes and appendixes) is the time zone applicable to the operation. Operations across several time zones use ZULU time.

Task Organization: Describe the allocation of forces to support the commander's concept. Task organization may be shown in one of two places: preceding paragraph one, or in an annex, if the task organization is long and complicated. (See Appendix F for a complete discussion of task organization.)

Figure H-3. Annotated OPLAN or OPORD format

OPLAN or OPORD _____ - _____
 (Number) (issuing headquarters)

(Place this information at the top of the second and any subsequent pages of the OPLAN or OPORD.)

1. SITUATION

a. Enemy forces. Express this information in terms of two enemy echelons below yours (for instance, corps address brigades; battalions address platoons). Describe the enemy's most likely and most dangerous course of action. When possible, provide a sketch of the enemy course of action in lieu of verbiage (Appendix ___ (sketch) to Annex B (Intelligence)). Include an assessment of terrorist activities directed against US government interests in the area of operations. Refer to Annex B (Intelligence) or the current intelligence estimate or intelligence summary (INTSUM). If you need to reference more sources, use the final subparagraph to refer the reader to the documentation.

b. Friendly forces. Include the mission, the commander's intent, and concept of operations for headquarters one and two levels up. Subparagraphs state the missions of flank units and other units whose actions would have a significant bearing on the issuing headquarters.

c. Attachments and detachments. Do not repeat information already listed under Task Organization or in Annex A (Task Organization). Try to put all information in the Task Organization or in Annex A and state, "See Task Organization" or "See Annex A." However, when not in the Task Organization, list units that are attached or detached to the headquarters that issues the order. State when attachment or detachment is to be effective if different from when the OPORD or OPLAN is effective (such as on order, on commitment of the reserve). Use the term "remains attached" when units will be or have been attached for some time.

d. Assumptions (OPLAN only). List all assumptions.

2. MISSION. State the mission derived during the planning process. There are no subparagraphs in a mission statement. The mission statement will cover on-order missions. (**NOTE:** See Chapter 5 for discussion of mission statement.)

3. EXECUTION

Intent: State the commander's intent derived during the planning process. (**NOTE:** See Chapter 5 for detailed discussion on the commander's intent.)

a. Concept of operations. The concept of operations may be a single paragraph, may be divided into two or more subparagraphs or, if unusually lengthy, may be prepared as a separate annex. The concept of operations should be based on the COA statement from the decision-making process and, at a minimum, will address close, deep, rear, security, and reserve operations as well as describe the type or form of operation and designate the main effort. The commander uses this subparagraph when he feels he must supply sufficient detail to ensure appropriate action by subordinates in the absence of additional communications or further instructions. The concept statement should be concise and understandable.

The concept describes—

- The employment of major maneuver elements in a scheme of maneuver.
- A plan of fire support or "scheme of fires" supporting the maneuver with fires.
- The integration of other major elements or systems within the operation. These include reconnaissance and security elements, intelligence assets, engineer assets, and air defense.

Figure H-3. Annotated OPLAN or OPORD format (continued)

- Any other aspects of the operation the commander considers appropriate to clarify the concept and to ensure unity of effort. If the integration and coordination are too lengthy for this paragraph, that integration and coordination are addressed in the appropriate annexes.
- Any be-prepared missions.

When an operation involves two or more clearly distinct and separate phases, the concept of operations may be prepared in subparagraphs describing each phase. Designate phases as "Phase" followed by the appropriate Roman numeral, for example, Phase I.

If the operation overlay is the only annex referenced, show it after "a. Concept of operations." Place the commander's intent and concept of operations statement on the overlay if the overlay does not accompany the OPORD or OPLAN.

NOTE: Depending on what the commander considers appropriate, the level of command, and the complexity of any given operation, the following subparagraphs are **examples** of what may be required within the concept of operations.

(1) Maneuver. State the scheme of maneuver derived during the planning process. Be sure this paragraph is consistent with the operation overlay. It must address the close, deep, and rear battles as well as security and reserve operations. This paragraph and the operation overlay should be complementary adding to the clarity of, rather than duplicating, each other. Do not duplicate information to be incorporated into unit subparagraphs or coordinating instructions.

(2) Fires. Clarify scheme of fires to support the overall concept. This paragraph should state which maneuver unit is the main effort and has priority of fires, to include stating purpose of, priorities for, allocation of, and restrictions for fire support. Refer to Annex D (Fire Support) if required. If the fire support annex is the only one referenced, show it after "(2) Fire Support." Refer to appropriate annexes as required. When referencing other annexes, identify them within the subparagraph where appropriate.

(3) Reconnaissance and Surveillance. This paragraph should specify the reconnaissance and surveillance plan and how it ties in with the basic concept of operations. It should address how these assets are operating in relation to the rest of the force. Refer to Annex L (Reconnaissance and Surveillance) if required.

(4) Intelligence. State the intelligence system concept supporting the scheme of maneuver. Describe the priority of effort among situation development, targeting, and battle damage assessment (BDA). Describe the priority of support to maneuver units and the priority of counterintelligence (CI) effort. Refer to Annex B (Intelligence) if required.

(5) Engineer. Clarify the scheme of engineer support to the maneuver plan paying particular attention to the integration of engineer assets, and obstacles. Indicate priority of effort and provide priority of mobility and survivability aspects as appropriate. Delegate or withhold authority to emplace obstacles. Refer to Annex F (Engineer) and other appropriate annexes as required.

(6) Air Defense. State overall concept of air defense in support of the scheme of maneuver, if necessary. Include considerations of potential Air Force counterair support as well as the actual contribution of dedicated AD units. Establish priority of air defense for GS units and provide AD weapons status and warning status. Refer to Annex G (Air Defense) and other appropriate annexes as required.

(7) Information Operations. State overall concept of information operations in support of the scheme of maneuver. Establish priority of support and refer to appropriate annexes as required.

NOTE: Units required to accomplish specific tasks for Information Operations, and Reconnaissance and Surveillance ((3) above) are specified in the appropriate subparagraphs of 3a, b, c, or paragraph 4.

Figure H-3. Annotated OPLAN or OPORD format (continued)

b. Tasks to maneuver units. Clearly state the missions or tasks for each maneuver unit that reports directly to the headquarters issuing the order. List units in the same sequence as in the task organization, including reserves. Use a separate subparagraph for each maneuver unit. Only state tasks that are necessary for comprehension, clarity, and emphasis. Place tactical tasks that affect two or more units in subparagraph 3d.

c. Tasks to combat support units. Use these subparagraphs only as necessary. List CS units in subparagraphs in the same order as they appear in the task organization. Use CS subparagraphs to list only those specific tasks that CS units must accomplish and that are not specified or implied elsewhere. Include organization for combat, if not clear from task organization.

(1) Intelligence. Annex B (Intelligence). Address the function or support roles of organic or attached combat C²W or MI units, if not clear in the task organization. Designate any special use of unmanned aerial vehicles (UAVs). Designate the placement of remote video terminals.

(2) Engineer. Annex F (Engineer). List organization for combat, if not in the task organization. Assign priorities of effort and support. Address functions or support roles of organic or attached engineer units if it is not clear in task organization. Establish priorities of work if not addressed in unit SOPs.

(a) Engineer units, priorities of work.

(b) Environmental considerations.

(3) Fire Support. Annex D (Fire Support). A fire support annex is usually published at division and corps levels. At brigade and lower, include fire support information here rather than in an annex.

(a) Air support. State allocation of CAS sorties, AI sorties (corps), and nominations (division). Show tactical air reconnaissance sorties here or in the intelligence annex. Include nuclear weapons target nominations (corps and echelons above corps (EAC) only).

(b) Field artillery support. Cover priorities such as counterfires or interdiction. State organization for combat, to include command and support relationships only if they are not clear in task organization. Ensure that allocation of fires supports the commander's concept. At brigade and lower, most of the fire support information is contained in a matrix format in the fire support annex.

(c) Naval gunfire support.

(d) Fire support coordinating measures.

(4) Air Defense. Annex G (Air Defense). Address the following for organic and attached AD units if not addressed in unit SOPs:

(a) Organization for combat.

(b) Missions.

(c) Priorities for protection.

(5) Signal. Annex H (Signal). List organization for combat, if not in the task organization. Assign priorities of effort and support. Address functions or support roles of organic or attached signal units if it is not clear in task organization. Establish priorities of work if not addressed in unit SOPs.

(6) NBC. Annex J (NBC). List organization for combat, if not in the task organization. Assign priorities of effort and support. Address functions or support roles of organic or attached chemical and smoke units if it is not clear in task organization. Establish priorities of work if not addressed in unit SOPs.

Figure H-3. Annotated OPLAN or OPORD format (continued)

(7) **Provost Marshal.** Annex K (PM). List organization for combat, if not in the task organization. Assign priorities of effort and support. Address functions or support roles of organic or attached MP units if it is not clear in task organization. Establish priorities of support to EPW operations, circulation control plan, and rear area security if not addressed in unit SOPs.

(8) **Psychological Operations (PSYOP).** Refer to Annex R if used.

(9) **Civil-Military Operations.** Refer to Annex U if used.

d. **Coordinating instructions.** *List only instructions applicable to two or more units and **not routinely covered in unit SOPs.*** This is always the last subparagraph in paragraph 3. Complex instructions should be referred to in an annex. Subparagraphs d(1)-d(5) below are mandatory.

(1) **Time or condition when a plan or an order becomes effective.**

(2) **Commander's critical information requirements (CCIR).** List once only here. Do not list in Annex B (Intelligence).

(a) **Priority intelligence requirements (PIR).**

(b) **Essential elements of friendly information (EEFI).**

(c) **Friendly force information requirements (FFIR).**

(3) **Risk reduction control measures.** These are measures unique to this operation and not included in unit SOPs and can include mission-oriented protective posture, operational exposure guidance, troop-safety criteria (corps only), vehicle recognition signals, and fratricide prevention measures.

(4) **Rules of engagement (ROE).** (NOTE: ROE can be addressed within its Annex.)

(5) **Environmental considerations.**

(6) **Force protection.**

(7) **Any additional coordinating instructions.**

4. SERVICE SUPPORT. Address service support in the areas shown below as needed to clarify the service support concept. Refer to annexes, if required. Subparagraphs can include:

a. **Support concept.** State the concept of logistics support to provide non-CSS commanders and their staffs a visualization of how the operation will be logistically supported. This could include—

- A brief synopsis of the support command mission.
- Support command headquarters or support area locations, including locations of the next higher logistic bases if not clearly conveyed in the CSS overlay.
- The next higher level's support priorities and where the unit fits into those priorities.
- The commander's priorities of support.
- Units in the next higher CSS organization supporting the unit.
- The use of host nation support.
- Significant or unusual CSS issues that might impact the overall operation.
- Any significant sustainment risks.

Figure H-3. Annotated OPLAN or OPORD format (continued)

- Unique support requirements in the functional areas of manning, arming, fueling, fixing, moving, and sustaining the soldier and his systems.
 - The support concept organized into a framework based on operational phasing, or presented as before, during, and after operations format.
- b. **Materiel and services.**
 - c. **Medical evacuation and hospitalization.**
 - d. **Personnel support.**

5. COMMAND AND SIGNAL

- a. **Command.** State the map coordinates for the CP locations and at least one future location for each command post. Identify the chain of command if not addressed in unit SOPs.
- b. **Signal.** List signal instructions not specified in unit SOPs; identify the specific signal operating instructions (SOI) addition in effect, required reports and formats, and times the reports are submitted.

ACKNOWLEDGE: Include instructions for the acknowledgement of the plan or order by addressees. The word acknowledge may suffice or you may refer to the message reference number. Acknowledgement of a plan or order means that it has been received and understood.

NAME (Commander's last name)
RANK (Commander's rank)

The commander or authorized representative signs the original copy. If the representative signs the original, add the phrase "For the Commander." The signed copy is the historical copy and remains in headquarters files.

OFFICIAL:

(Authentication) Use only when applicable. If the commander signs the original, no further authentication is required. If the commander doesn't sign, authentication is required by the signature of the preparing staff officer and only the last name and rank of the commander appear in the signature block.

ANNEXES: List annexes by letter and title in the sequence shown in Figure H-9, page H-34. If a particular annex is not used, place a "not used" beside that annex letter.

DISTRIBUTION: Furnish distribution copies either for action or for information. List in detail those who are to receive the plan or order. If necessary, also refer to an annex containing the distribution list or to a standard distribution list or SOP. When referring to a standard distribution list, also show distribution to reinforcing, supporting, and adjacent units, since that list does not normally include these units. When distribution includes a unit from another nation or from a NATO command, cite the distribution list in full.

(Classification)

Place the required classification at the top and bottom of every page of the OPLAN or OPORD.

Figure H-3. Annotated OPLAN or OPORD format (continued)

(Classification)

Place the required classification at the top and bottom of every page of the SSPLAN or SSORD.

(Change from oral orders, if any)

This annotated order follows the same format as the OPORD/OPLAN. Only specific items that pertain to the SSPLAN are discussed.

Copy __ of __ copies
Issuing headquarters
Place of issue
Date-time group of signature
Message reference number

SERVICE SUPPORT PLAN (ORDER) _____ (code name)
(Number)

Related operation plan (order) _____ (when applicable).
(Number)

References:

Time Zone Used Throughout the Plan (Order):

Task Organization: List the number and coordinates of service support units here or in a trace or overlay. If you do not list units here, omit this heading.

1. SITUATION. State the general service support factors affecting support of the operation. Include any information essential to understanding the current situation as it influences combat service support. This comes from paragraph 1 of the related OPLAN or OPORD on the general overall situation.

a. Enemy forces. Refer to an OPORD or to the intelligence annex to an OPORD if it has been published or is to be published. List information about the composition, disposition, location, movements, estimated strengths, and identifications of enemy forces. List enemy capabilities that could influence the CSS mission.

b. Friendly forces. List pertinent information on own forces (other than those a referenced OPORD covers or that subsequent paragraphs of this order include) that might directly influence the CSS mission.

c. Attachments and detachments. See OPLAN/OPORD.

d. Assumptions (OPLAN only). Same as OPLAN/OPORD.

2. MISSION. State the CSS tasks and their purpose.

3. EXECUTION

NOTE: There is no commander's intent statement for a SSPLAN or SSORD.

Concept of support operations. Outline the general service support plan for CSS and any instructions that succeeding paragraphs do not suitably cover (for example, location of the division support area, location of coordinating agencies, general instructions for movement of bases).

4. SERVICE SUPPORT

a. Materiel and services.

Figure H-4. Annotated service support plan (order) format

SSPLAN or SSORD NO _____

(1) Supply. This paragraph contains a subparagraph for each class of supply, maps, water, special supplies, excess materiel, salvage materiel, and captured enemy materiel. Each subparagraph contains the location of the installations that handle supplies and materiel for supported units, the time of opening or closing, operating units, supported units, levels of supply, methods and schedules of distribution, and other pertinent instructions or information supported units will need. Instructions or information for two or more classes of supply may be listed under one paragraph. However, do not sacrifice clarity. For Class V, include the designation and location of the approving agency for ammunition requisitions and the controlled supply rate, as appropriate.

(2) Transportation. Include location of terminals and installations (rail stations, airfields, and ports); operating units; schedules (march tables, timetables, and rail movement tables); area responsibilities of the transportation movement officers and highway regulating teams; traffic control and regulation measures, such as regulations, restrictions, allocation priorities, and regulating and control points; and designation of the main supply routes. Modes covered in this subparagraph may include ocean, inland waterway, coastal, highway, air, and rail. This paragraph will include procedures to request transportation support.

(3) Services. Include information or instructions for support units that prescribe the type of service available, designation and location of the unit or installation providing the service, assignments to support units, and schedules for service, if applicable. Include specific missions for service units supporting operations. For example, include priority of effort of general engineering missions. Under each subparagraph, list pertinent service installations stating location, operating units, and assignments to supported units. In addition, assign any special missions that are not covered in other orders to service units in these subparagraphs.

(a) Field services. Include food preparation, water purification, aerial delivery, showers, laundry, clothing repair, light textile repair, and mortuary affairs. For mortuary affairs, establish location of collection points, evacuation procedures, and handling of personal effects. Include procedures for emergency and temporary burials, mass burials, or contaminated remains.

(b) Installation service. List real estate, repair and utilities, fire protection, sewage and trash disposal, hazardous materiel and waste disposal, and water supply services. Establish base camps to house soldiers.

(c) Other. Include any unique service support requirements for explosive ordnance disposal and contingency contracting.

(4) Labor. Include policies, with any restrictions, on using civilian and enemy prisoners of war and civilian internees or detainees in labor units; allocation and priorities of available labor; and designation and location of labor units available.

(5) Maintenance. Include priority of maintenance, location of facilities, collection points, maintenance time lines, and evacuation procedures.

b. Medical evacuation and hospitalization. Include information and instructions for supported units prescribing the plan for collection, triage, medical evacuation, and medical treatment of sick, injured, and wounded soldiers including enemy prisoners of war. List procedures to be used for chemical casualties.

Figure H-4. Annotated service support plan (order) format (continued)

SSPLAN or SSORD NO _____

(1) Evacuation. Include ambulance exchange points (AXPs) and establishment of ambulance shuttles, routes, means, and schedules of evacuation; evacuation and en route treatment policies for the use of nonmedical transportation assets; specific policies for evacuation by air or ground and evacuation of NBC-contaminated patients; information about MEDEVAC request procedures and channels; and evacuation or holding policies.

(2) Treatment. Include a list of all appropriate treatment facilities (for example, dispensaries, aid stations, clearing stations, hospitals) belonging to or supporting organizations; the location and operational time of supporting hospitals, medical regulating matters, and evacuation policy; and the establishment of patient decontamination facilities.

(3) Other services. Include pertinent information on any other combat health support matters (for example, dental, preventive medicine, health service logistics, combat stress control, veterinary). Include unit locations, support information, policies, requirements for nonmedical augmentation to accomplish patient decontamination, support requirements for providing nonmedical guards for enemy prisoners of war evacuated within CHS channels, and any other information, as appropriate.

c. Personnel.

(1) Personnel matters. Include all necessary information and instructions on personnel matters, including foreign civilian labor used in direct military support functions. List information under each of the following subparagraphs, when applicable.

- Installations. Location and time of opening or closing.
- Operating units. The units or areas served.
- Rotation criteria.
- Unit responsibility for movement or administration of personnel.
- Requisitions or plans concerning personnel activities.
- Necessary references to previous order, instructions, or SOP.

(2) Maintenance of unit strength.

(a) Strength reports. Include instructions for submission of strength reports. Include requirements for routine reports and special reports following an attack using weapons of mass destruction, and after a natural disaster or serious incident.

(b) Replacements. Include a statement establishing the validity of existing personnel requisitions, instructions for submission of requisitions, instructions for processing and moving replacements, the location of replacement units and the units each will support, and the type and location of unit replacements under control of the issuing headquarters.

(3) Casualty operations. Include instructions for recording, reporting, verifying, and processing casualty information.

(4) Personnel management.

Figure H-4. Annotated service support plan (order) format (continued)

SSPLAN or SSORD NO _____

(a) Military personnel. Include information or instructions concerning classification, assignment, promotion, transfer, reclassification, reduction, elimination, retirement, separation, training, rotation, and personnel economies.

(b) Civilian personnel. List sources of civilian labor; locations of civilian personnel offices or other labor administration centers and labor pools; procurement policies and procedures; restrictions on use of civilian labor; administrative and control procedures; pay schedules, allowances, and CSS to be provided; and responsibilities of subordinate commanders for administration. Provide specific pay scales and other conditions of employment in an annex.

(c) Enemy prisoners of war and civilian internees or detainees. Include instructions concerning collecting, safeguarding, processing, evacuating, using, treating, and disciplining enemy prisoners of war and civilian internees or detainees and all other personnel arrested or captured but not immediately identifiable as enemy prisoners of war. Include the location of EPW and civilian internee or detainee facilities.

(5) Personnel service support (PSS). Include information or instructions concerning leaves; rest and recreation facilities, to include criteria and unit quotas; decorations and awards; postal and finance services; chaplain activities and religious coverage; field services; morale support activities; post exchange; and legal assistance.

(6) Discipline, law and order. Include information and instructions concerning troop conduct and appearance; the control and disposition of stragglers, locations of straggler-collecting points, and special instructions for straggler-control augmentation; instructions for administering military justice; and any information or instructions concerning relations between military and civilian personnel, such as fraternization, black marketing, selling of government property, and respect for local laws.

(7) Headquarters management. Include instructions concerning movement, internal arrangement, organization, operation of headquarters, and allocation of shelter in the headquarters area for troops and headquarters personnel.

(8) Miscellaneous. Include any personnel administrative matters not specifically assigned to another coordinating staff section or included in the preceding subparagraphs.

d. Foreign nation support and host nation support. This paragraph covers the concept for foreign nation support and host nation support during the operation. It includes plans for both forecasted and unforecasted support.

e. Coordinating instructions. This is the same as in the OPLAN/OPORD.

(1) Boundaries. Location of the rear boundary and any other boundary needed for CSS purposes.

(2) Protection. Measures established for the protection of CSS units or installations. Specify which tactical units are to provide protection, which CSS units or installations will receive protection, and any conditioning factors to that protection. This paragraph provides information for CSS units; it is not an order to tactical units. Include pertinent instructions from the rear operations plan or reference to an annex or both.

(3) Special reports. Include those reports requiring special emphasis that are required but are not included in previous paragraphs or reports.

Figure H-4. Annotated service support plan (order) format (continued)

SSPLAN or SSORD NO _____

(4) **Other CSS matters.** Include information or instructions not included in any previous paragraph.

(5) **Execution.** Include the time or the conditions under which the plan is to be placed in effect.

5. COMMAND AND SIGNAL

a. **Command.**

b. **Signal.** Refer to appropriate OPLAN/OPORD. When not included in the basic OPLAN/OPORD, include the headquarters location and movements, liaison arrangements, recognition and identification instructions, and general rules concerning the use of communications and other electronic equipment, if necessary. Use an annex when appropriate.

ACKNOWLEDGE:

NAME (Commander's last name)

RANK (Commander's rank)

Same as OPLAN/OPORD.

OFFICIAL: (Authentication) Same as OPLAN/OPORD.

ANNEXES: Same as OPLAN/OPORD.

DISTRIBUTION:

(Classification)

Figure H-4. Annotated service support plan (order) format (continued)

 (Classification)
 (Change from oral orders, if any)

Copy __ of __ copies
Issuing headquarters
Place of issue
Date-time group of signature
Message reference number

MOVEMENT ORDER _____

References:

Time Zone Used Throughout the Order:

Task Organization:

1. SITUATION

- a. **Enemy forces.**
- b. **Friendly forces.**
- c. **Attachments and detachments.**

2. MISSION

3. EXECUTION

- a. **Concept of movement.**
- b. **Tasks to subordinate units.**
- c. **Detailed timings.**
- d. **Coordinating instructions.**
 - (1) **Order of march.**
 - (2) **Routes.**
 - (3) **Density.**
 - (4) **Speed.** (Include catch-up speed.)
 - (5) **Method of movement.**
 - (6) **Defense on move.**
 - (7) **Start, release, or other critical points.**
 - (8) **Convoy control.**
 - (9) **Harbor areas.**
 - (10) **Instructions for halts.**
 - (11) **Lighting.**
 - (12) **Air Support.**

Figure H-5. Movement order format

MOVEMENT ORDER _____

4. SERVICE SUPPORT

- a. Traffic control (performed by MPs).
- b. Recovery.
- c. Medical.
- d. Petroleum, oils, and lubricants.
- e. Water.

5. COMMAND AND SIGNAL

- a. Command.
 - (1) Location of commander and chain of command.
 - (2) Locations of key individuals or particular vehicles.
- b. Signal.

ACKNOWLEDGE:

NAME (Commander's last name)
RANK (Commander's rank)

OFFICIAL:
ANNEXES:
DISTRIBUTION:

(Classification)

Figure H-5. Movement order format (continued)

(Classification)

(Change from oral orders, if any) (Optional)

A WARNING ORDER DOES NOT AUTHORIZE EXECUTION UNLESS SPECIFICALLY STATED

Copy ___ of ___ copies
Issuing headquarters
Place of issue
Date-time group of signature
Message reference number

WARNING ORDER _____

References: Refer to higher headquarters OPLAN/OPORD, and identify map sheet for operation. Optional.

Time Zone Used Throughout the Order: (Optional)

Task Organization: (Optional) (See paragraph 1c.)

1. SITUATION

a. Enemy forces. Include significant changes in enemy composition dispositions and courses of action. Information not available for inclusion in the initial WARNO can be included in subsequent warning orders.

b. Friendly forces. (Optional) Only address if essential to the WARNO.

(1) Higher commander's mission.

(2) Higher commander's intent.

c. Attachments and detachments. Initial task organization, only address major unit changes.

2. MISSION. Issuing headquarters' mission at the time of the WARNO. This is nothing more than higher headquarters' restated mission or commander's decisions during MDMP.

3. EXECUTION

Intent:

a. Concept of operations. Provide as much information as available, this may be none during the initial WARNO.

b. Tasks to maneuver units. Any information on tasks to units for execution, movement to initiate, reconnaissance to initiate, or security to emplace.

c. Tasks to combat support units. See paragraph 3b.

d. Coordinating instructions. Include any information available at the time of the issuance of the WARNO. It may include the following:

- CCIR.
- Risk guidance.
- Deception guidance.
- Specific priorities, in order of completion.

Figure H-6. Warning order (WARNO) format

WARNO _____

- Time line.
 - Guidance on orders and rehearsals.
 - Orders group meeting (attendees, location, and time).
 - Earliest movement time and degree of notice.
4. **SERVICE SUPPORT.** (Optional) Include any known logistics preparation for the operation.
- a. Special equipment. Identifying requirements, and coordinating transfer to using units.
 - b. Transportation. Identifying requirements, and coordinating for pre-position of assets.
5. **COMMAND AND SIGNAL** (Optional)
- a. Command. State the chain of command if different from unit SOP.
 - b. Signal. Identify current SOI edition, and pre-position signal assets to support operation.

ACKNOWLEDGE: (Mandatory)

NAME (Commander's last name)
RANK (Commander's rank)

OFFICIAL: (Optional)

(Classification)

Figure H-6. Warning order (WARNO) format (continued)

 (Classification)
 (Change from oral orders, if any)

Copy ___ of ___ copies
Issuing headquarters
Place of issue
Date-time group of signature
Message reference number

FRAGMENTARY ORDER _____

References: (Mandatory) Reference the order being modified.

Time Zone Used Throughout the Order (Optional)

1. **SITUATION.** (Mandatory) Include any changes to the existing order.

2. **MISSION.** (Mandatory) List the new mission.

3. **EXECUTION**

Intent: (Optional)

a. **Concept of operations.** (Mandatory)

b. **Tasks to subordinate units.** (Mandatory)

c. **Coordinating instructions.** (Mandatory) Include statement, "Current overlay remains in effect" or "See change 1 to Annex C, Operations Overlay." Mark changes to control measures on overlay or issue a new overlay.

4. **SERVICE SUPPORT.** Include any changes to existing order or the statement, "No change to OPORD xx."

5. **COMMAND AND SIGNAL.** Include any changes to existing order or "No change to OPORD xx."

ACKNOWLEDGE: (Mandatory)

NAME (Commander's last name)
RANK (Commander's rank)

OFFICIAL: (Optional)

ANNEXES: (Optional)

DISTRIBUTION: (Optional)

 (Classification)

Figure H-7. Fragmentary order (FRAGO) format

(Classification)
(Change from oral orders, if any)

Copy ___ of ___ copies
Issuing headquarters
Place of issue
Date-time group of signature
Message reference number

OVERLAY ORDER _____ (code name)
(number)

References:

Time Zone Used Throughout the Order:

Task Organization: List only changes on the overlay.

1. **SITUATION.** List any changes to enemy or friendly situation.
 - a. **Enemy forces.** Verbal brief, referring to enemy unit locations (known or suspected) on the overlay.
 - b. **Friendly forces.** Verbal brief, referring to friendly unit locations on the overlay.
 - c. **Attachments and detachments.** Verbal brief, confirms changes to task organization.
 - d. **Commander's evaluation.** Verbal brief.

2. **MISSION.** Written on the overlay.

3. **EXECUTION**

Intent:

- a. **Concept of operations.** Verbal brief, referring to the overlay. Focus is on key events, identifying the main effort, priorities of fires, and trigger points to execute engagements.
- b. **Tasks to maneuver units.** Written, for each subordinate unit, on the overlay. Specified tasks for each unit only.
- c. **Tasks to CS units.** Verbal brief, identifies priority of support.
- d. **Coordinating instructions.** Verbal brief, covers only items not covered in unit SOPs. Focus on control measures and graphics.

4. **SERVICE SUPPORT.** Verbal brief, referring to the overlay for locations of support. Any changes to sustainment.

5. **COMMAND AND SIGNAL**

- a. **Command.** Verbal brief, refer to the overlay for location of key personnel, and identify the succession of command.
- b. **Signal.** Verbal brief, and any code words which key events.

Figure H-8. Overlay order format

OVERLAY ORDER _____

ACKNOWLEDGE: List on the overlay

NAME (Commander's last name)

RANK (Commander's rank)

List on the overlay

OFFICIAL: Authentication by preparing staff officer, if not signed by the commander.

ANNEXES: None will be used.

DISTRIBUTION: Per unit SOP.

(Classification)

Figure H-8. Overlay order format (continued)

TASK ORGANIZATION:

A/4-78 MECH

1/A/4-78 MECH
 2/A/4-78 MECH
 3/C/4-5 AR
 SGT PLT/4-78 MECH
 1/1/B/4-441 ADA(DS)
 1/2/B/52 MI(GSR)(DS)

O/O 1/A/4-78 MECH
 2/A/4-78 MECH

B/4-78 MECH

1/B/4-78 MECH
 2/B/4-78 MECH
 3/D/4-5 AR

C/4-5 AR

1/C/4-5 AR
 2/C/4-5 AR
 3/A/4-78 MECH

D/4-5 AR

1/D/4-5 AR
 2/D/4-5 AR
 3/B/4-78 MECH

TF Control

A/32 EN(DS)
 1/B/4-441 ADA(-)(DS)

O/O 3/C/4-5 AR(Reserve)
 A/32 EN(DS)
 1/B/4-441 ADA(DS)
 1/2/B/52 MI(GSR)(DS)
 SGT/4-78 MECH
 MTR/4-78 MECH

Mission: NLT H+48, TF 4-78 MECH defends in sector to contain elements of the 3rd and 9th MRDs in order to protect the flank of TF 4-5 AR and deny enemy penetration of PL MUSKET.

EXECUTION- TASKS TO SUBORDINATE UNITS:

- a. A/4-78 MECH:
 1. Screen north of PL YELLOW to deny enemy reconnaissance observation of MBA preparations.
 2. Prepare and Occupy O/O BP3 orienting fires into EA2 to deny enemy penetration of PL MUSKET to protect the right flank of B/4-78 MECH, the TF Main Effort.
- b. B/4-78 MECH: TF Main Effort - Prepare and Occupy BP2 orienting fires into EA 1 and 2 in order to deny penetration of PL MUSKET.
- c. C/4-5 AR: Prepare and Occupy BP1 orienting fires into EA 1 and 2 to deny penetration of PL MUSKET and to protect the left flank of B/4-78 MECH, the TF Main Effort.
- d. D/4-5 AR: Prepare and Occupy BP4 to deny enemy access to high mobility corridors along Stranger Creek and force the enemy into EA2.
- e. 3/C/4-5 AR: Occupy AA READY as TF Reserve. Priority of commitment is to occupy BP's 55, 66, or 77 in order to deny penetration of PL MUSKET by a company size element.
- f. SCT/4-78 MECH:
 1. Screen North along PL GRAY to deny enemy reconnaissance observation of MBA preparations by vectoring in the killing systems of A/7-8 MECH to destroy enemy reconnaissance elements.
 2. O/O screen along the TF western boundary from PL BLUE to PL BAYONET to protect the TF right flank.
- g. 1/B/4-441 ADA: Provide area coverage with priority of protection to B/4-78 MECH, TF Main Effort, C2, CSS, and Combat Systems.
- h. 1/2/B/52 MI(GSR):
 1. Attached to A/4-78 MECH.
 2. O/O occupy under TF Control position on the western boundary oriented into EA4 to provide early warning.

Acknowledge: A/4-78 MECH, B/4-78 MECH, C/4-5 AR, D/4-5 AR, 1/B/4-441 ADA, SCT/4-78 MECH, MTR/4-78 MECH

MOORE
 LTC

Official
 Parker
 S3

Figure H-8. Overlay order format (continued)

SECURITY CLASSIFICATION
 ANNEX C (OPERATIONS OVERLAY) TO OPERATION ORDER
 MAP REFERENCE

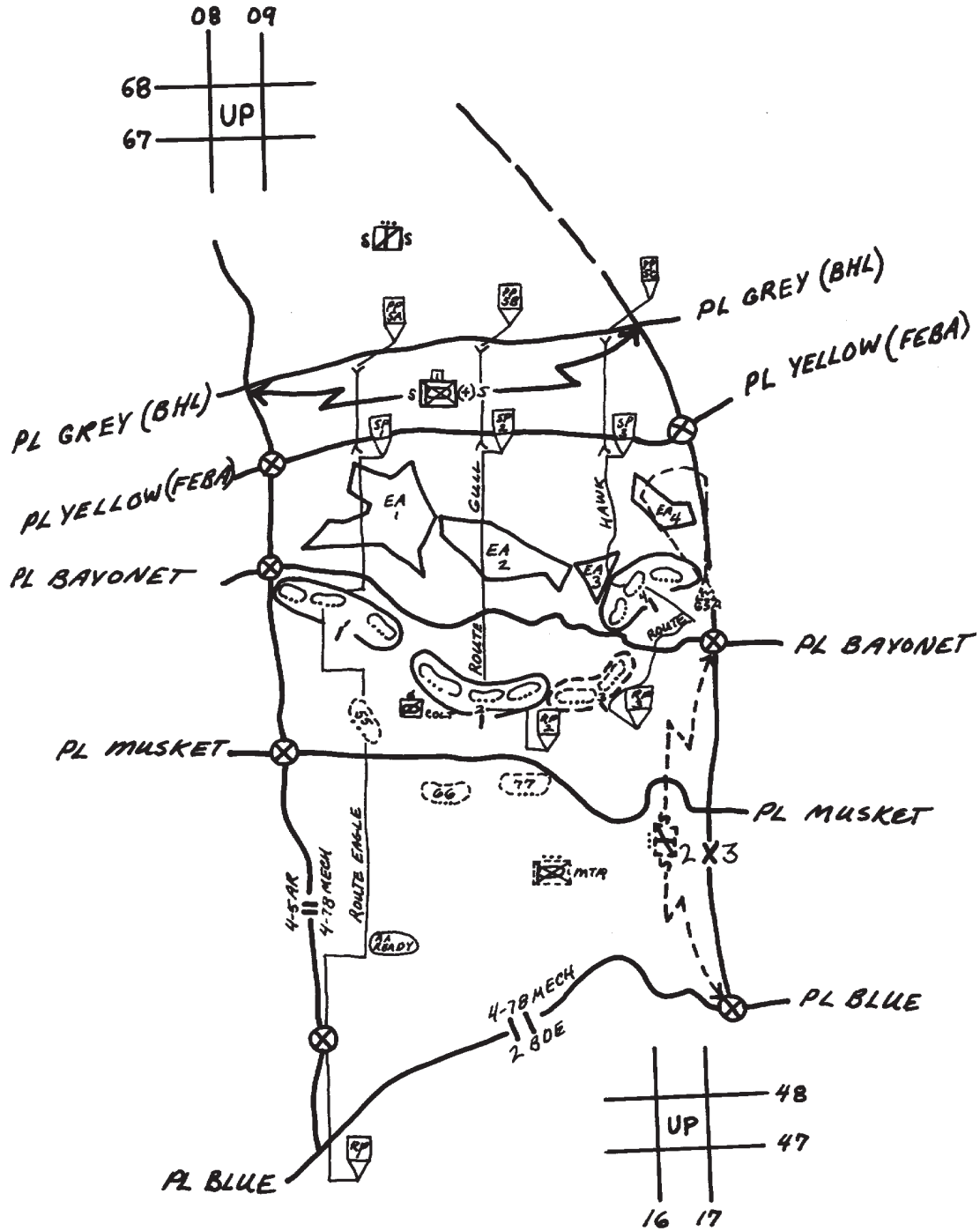

SECURITY CLASSIFICATION

Figure H-8. Overlay order format (continued)

- Annex A Task Organization
- Annex B Intelligence
 - Appendix 1 Initial IPB
 - Tab A Modified Combined Obstacle Overlay (MCOO)
 - Tab B Enemy Situation Template
 - Tab C Analysis of AO
 - Appendix 2 Collection Management
- Annex C Operation Overlay
- Annex D Fire Support
 - Appendix 1 Air Support
 - Appendix 2 Field Artillery Support
 - Appendix 3 Naval Gunfire Support
- Annex E Rules of Engagement (ROE)
- Annex F Engineer
 - Appendix 1 Engineer Overlay
 - Appendix 2 Environmental Considerations
- Annex G Air Defense
- Annex H Signal
- Annex I Service Support
 - Appendix 1 Service Support Overlay
 - Appendix 2 Traffic Circulation and Control
 - Tab A Traffic Circulation (Overlay)
 - Tab B Road Movement Table
 - Tab C Highway Regulations
 - Appendix 3 Personnel
 - Appendix 4 Legal
 - Appendix 5 Religious Support
- Annex J Nuclear, Biological, and Chemical (NBC) Operations
- Annex K Provost Marshal (PM)
- Annex L Reconnaissance and Surveillance Operations
- Annex M Deep Operations
- Annex N Rear Operations
- Annex O Airspace Command and Control (AC²)
- Annex P Command and Control Warfare (C²W)
- Annex Q Operations Security (OPSEC)
- Annex R PSYOP
- Annex S Deception
- Annex T Electronic Warfare (EW)
- Annex U Civil-Military Operations (CMO)
- Annex V Public Affairs

Figure H-9. Sequence of annexes and appendixes to OPLANs or OPORDs

 (Classification)
 (Change from oral orders, if any)

Copy __ of __ copies
Issuing headquarters
Place of issue
Date-time group of signature
Message reference number

ANNEX __ (Title) TO OPERATION ORDER NO _____

References: Maps, charts, datum, and other relevant documents.

Time Zone Used Throughout the Order:

1. SITUATION. Include information affecting the functional area that paragraph 1 of the OPORD does not cover or that needs to be expanded.

a. Enemy. See Annex B (Intelligence) or intelligence estimate, and analysis of area of operations if available.

(1) Terrain. List all critical terrain aspects that would impact functional areas operations.

(2) Weather. List all critical weather aspects that would impact functional area operations.

(3) Enemy functional area capability and/or activity:

- List known and templated locations and activities of enemy functional area units. Information is normally gathered one level up and two levels down.

- List significant enemy maneuver and functional area capabilities that impact friendly functional area operations.

- State the expected employment of enemy functional area assets based on the most probable enemy course of action.

b. Friendly situation.

- Outline the plan of the higher headquarters as it pertains to the functional area.

- List designation, location, and outline of the plan of higher, adjacent, and other functional area assets that support or would otherwise impact the issuing headquarters or would require coordination, and any other functional area supporting the unit.

- List nonfunctional-area units capable of assisting in functional area operations (such as non-engineer units capable of emplacing scatterable mines).

c. Attachments and detachments.

(1) List units attached or detached only as necessary to clarify task organization.

(2) Highlight changes in functional area task organization that occur during the operation, including effective times or events.

2. MISSION. State the mission of the functional area in support of the basic OPORD or OPLAN.

Figure H-10. Annex and appendix format (general)

ANX __ (Abb title) TO OPORD NO _____

3. EXECUTION

a. **Scheme of support.** May be titled "Scheme of (functional area) operations" or "support."

- Describe the concept of functional area operations to support the commander's intent and the maneuver plan, tying in critical functional area tasks or the functional area's main effort by mission.
- Establish the main functional area effort by mission and unit for each phase of the operation.
- State functional area priorities.

b. **Tasks to subordinate units.**

- List functional area tasks that specific maneuver elements are to accomplish that the base OPORD does not contain.
- List functional area tasks the functional area units supporting maneuver elements are to accomplish only as necessary to ensure unity of effort.

c. **Coordinating instructions.** Include only instructions common to two or more units not already covered in the base OPORD.

- State specific rules of engagement that apply to the functional area.
- Refer to supporting appendixes not referenced elsewhere.
- Do not include SOP information.

4. SERVICE SUPPORT

a. **Command-regulated classes of supply.** Highlight subordinate allocations of command-regulated classes of supply that impact functional area operations (such as the controlled supply rate). Summarize in a matrix or table, if necessary.

b. **Supply distribution plan.**

- State the method of supply (supply point or unit distribution) to be used for appropriate classes of supply for each subordinate or supporting unit.
- Give tentative locations for supply points or locations for linkup of push packages direct to units.
- Give allocation of classes of supply supplies by subordinate unit, control measure, or combination. Summarize in a matrix or table, if necessary.

c. **Transportation.** State the allocation and priority of support of haul or airlift assets dedicated for haul of classes of supply.

d. **Combat health support.** Address arrangements made for health support of functional area units operating in forward maneuver unit areas.

e. **Maintenance.** State priority of support, locations of maintenance facilities, and any relevant policies.

f. **Field services.** State priority of support, locations of facilities, and command policies.

g. **Host nation.**

- List the type and location of HN functional area facilities, assets, or support.

Figure H-10. Annex and appendix format (general) (continued)

ANX __ (Abb title) TO OPORD NO _____

- List the procedures for requesting and acquiring HN functional area support.
- Highlight any limitations or restrictions on HN support.

5. COMMAND AND SIGNAL

a. Command.

- State the location of key functional area leaders.
- Designate a functional area chain of command, to include succession of command.
- Designate a functional area headquarters to control the functional area effort within functional area work lines on an area basis.
- List command posts and other C² facilities and their locations.

b. Signal.

- State the SOI edition in effect. Do not write “current SOI in effect”; state the specific edition number.
- Describe the nets that must be monitored for reports.
- Designate critical functional area reporting requirements of subordinate units.
- Address any unique communications or digitization connectivity requirements or coordination necessary to meet functional responsibilities.

ACKNOWLEDGE:

NAME (An annex or appendix can be signed by either the commander or primary staff officer)
RANK

**APPENDIXES:
 DISTRIBUTION:**

(Classification)

Figure H-10. Annex and appendix format (general) (continued)

ANNEX A (TASK ORGANIZATION) TO OPERATION ORDER NO _____

See Appendix F for methodology of task organization.

Figure H-11. Annex A (Task Organization) instructions and format

ANNEX B (INTELLIGENCE) TO OPERATION ORDER NO _____

See Figure H-10, page H-36, for completing this annex. Additional intelligence-specific items are listed below to ensure inclusion in this annex.

1. SITUATION**2. MISSION****3. EXECUTION.** This annex implements the command's intelligence collection plan.**a. Scheme of support.**

b. Tasks to subordinate units. List by unit (in a separate, numbered subparagraph) detailed instructions for intelligence acquisition tasks. List units in the same order as in the OPORD. List particular operational tasks for the command's intelligence and electronic warfare (IEW) unit, to include special communications and downlink arrangements.

c. Multidiscipline counterintelligence. List any special operational instructions having CI aspects. Certain instructions and procedures on the operations of special personnel may require limited dissemination on a need-to-know basis. Therefore, the unit may need to prepare a special multidiscipline CI-measures appendix for limited distribution.

d. Coordinating instructions.

(1) Other intelligence requirements (IR). List each intelligence requirement in priority in a separate subparagraph. Assign each IR a latest time intelligence of value and tie each to an operational decision point.

(2) Intelligence acquisition. List requests for information to higher, adjacent, and cooperating units in separate, lettered subparagraphs.

(3) Measures for handling personnel, documents, and materiel.

(a) Prisoners of war, deserters, repatriates, inhabitants, and other persons. State special handling, segregation instructions, and locations of the commands and next higher headquarters' EPW collection point.

(b) Captured documents. List instructions for handling and processing captured documents from time of capture to receipt by specified intelligence personnel.

(c) Captured materiel. Designate items or categories of enemy materiel required for examination. Include any specific instructions for their processing and disposition. Give locations of the command's and next higher headquarters' captured materiel collection point.

(4) Documents or equipment required. List in each category the conditions under which units can obtain or request certain documents or equipment. Items may include air photographs and maps, charts, and geodesy products.

(5) Distribution of intelligence products. State the conditions (for example, dates, number of copies, issue) regulating the issue of intelligence reports to the originating command for the operation's duration. This paragraph may cover any or all of the following: periods that routine reports and distribution cover; periodic or special conferences of intelligence officers; distribution of special intelligence studies, such as defense overprints, photo intelligence reports, and order of battle overlays; and special intelligence liaison, when indicated.

Figure H-12. Annex B (Intelligence) instructions and format

(6) Other instructions.

4. SERVICE SUPPORT

5. COMMAND AND SIGNAL

- a. Identify command intelligence handover line.
- b. Identify intelligence liaison requirements.
- c. Identify special security office (SSO) arrangements and coordination.

Figure H-12. Annex B (Intelligence) instructions and format (continued)

ANNEX C (OPERATION OVERLAY) TO OPERATION ORDER NO _____

1. Center the *security classification* at the top and bottom of the overlay. Use the largest and widest letters possible.
2. Place the *title* in the upper left margin (below the security classification).
3. Place the *map reference* in the upper left margin immediately below the title.
4. Place at least two *overlay and map reference points* (double cross-hair reference marks on map grid lines) on opposite corners of the overlay.
5. Use the same map scales as subordinate units will use.
6. Correctly transfer control measures onto the overlay from the higher headquarters' OPLAN or OPORD.
7. Provide a coordinate appendix (a list of coordinates for major C² points, unit locations, coordinating points, and so on) with the overlay.
8. Make the overlay consistent with the applicable text from the OPLAN or OPORD.
9. Place symbols on doctrinally correct locations. (Before placing symbols on an overlay, always consider the effect of terrain and weather.)
10. Keep the overlay simple, but give enough detail for others to understand the operation and its essential tasks.
11. Limit control measures to the minimum number needed to synchronize the operation or to limit possible fratricide.
12. Make sure control measures give the commander flexibility to react to changing situations or conditions.
13. When transmitting or storing overlays, roll up or fold the overlay with the classification, title, and map reference visible on the outside.

NOTE: An overlay must *always* contain the first four items listed here.

Figure H-13. Annex C (Operation Overlay) instructions and format

ANNEX D (FIRE SUPPORT) TO OPERATION ORDER NO _____

See Figure H-10 for completing this annex. Additional specific items are listed below to ensure inclusion in this annex.

1. SITUATION

a. Enemy forces.

- Include a detailed description of enemy fire support and AD assets.
- List enemy rocket, cannon, or missile artillery units, including those organic to maneuver units, as being committed or reinforcing. List all artillery units that can be identified as being committed or reinforcing. Consider all artillery units that can be identified as being within supporting range, as being in support of the committed force. Include the number of possible enemy air sorties by day, if known. Estimate the number, type, yield, and delivery means of enemy NBC weapons available to the committed force.

b. Friendly forces.

- (1) State the higher headquarters' concept of fires.
- (2) Provide adjacent units' concept of fires.
- (3) Include supporting air power and naval forces.

c. Attachments and detachments. List fire support resources, attached or under the operational control of the unit by higher headquarters, and any units detached or under the operational control of other headquarters.

2. MISSION

3. EXECUTION

a. Concept of fires. Describe how fires will be used to support the maneuver commander's concept of operations. Address the priority of fire support.

b. Air support.

- (1) **General.** Briefly describe the maneuver commander's concept for the use of air power.
- (2) **Air interdiction (AI) .**
- (3) **Close air support (CAS) .**
- (4) **Electronic combat (EC) .**
- (5) **Reconnaissance and surveillance operations.**
- (6) **Miscellaneous.**
 - The air tasking order's (ATO's) effective time period.
 - Deadlines for submission of AI, CAS, search and rescue, and EC requests.
 - The mission request numbering system as it relates to the target numbering system.
 - The joint suppression of enemy air defense (JSEAD) tasking from the joint force land component commander (JFLCC).

Figure H-14. Annex D (Fire Support) instructions and format

- Essential AC2 measures (coordinating altitude, target areas, low-level transit route (LLTR) requirements, and so on) identified in the AC2 annex.

c. Field artillery support.

(1) **General.** Include the concept for use of cannon, rocket, and missile artillery in support of close, deep, and rear operations.

(2) **Artillery organization for combat.**

(3) **Allocation of ammunition.**

(4) **Miscellaneous.**

- Changes to the targeting numbering system.
- The use of pulse repetition frequency (PRF) codes.
- Positioning restrictions.

d. Naval gunfire support.

(1) **General.** Include the concept for use of naval gunfire support.

(2) **Naval gunfire organization.**

(3) **Miscellaneous.**

- Trajectory limitations or minimum safe distances.
- Frequency allocations.
- Reference to a naval gunfire support annex.

e. Nuclear operations (corps and EAC only).

f. Smoke operations.

g. Target acquisition. Include information pertaining to the employment and allocation of FA target-acquisition systems and IEW assets. Refer to an FA support plan for specific target-acquisition tasks, if needed. The FA support plan can include planning products such as an observation matrix, a fire support execution matrix, a radar deployment order, or a target-acquisition appendix.

h. Coordinating instructions.

- Provide boundaries of the deep operations area.
- List the targeting products (target-selection standards matrix, high-payoff target list (HPTL), and attack-guidance matrix.
- Include fire support coordination measures.
- Refer to time of execution of program of fires relative to H-hour.
- Include rules of engagement.
- List fire support rehearsal times and requirements.
- List target allocations.
- List FASCAM allocations and requirements.

Figure H-14. Annex D (Fire Support) instructions and format (continued)

4. SERVICE SUPPORT. Identify the location of ammunition transfer points and ammunition supply points, or refer to the logistics overlay. List the controlled supply rate, if needed.

5. COMMAND AND SIGNAL

ACKNOWLEDGE:

**NAME
RANK**

- APPENDIXES:**
- 1 Air Support
 - 2 Field Artillery
 - 3 Naval Gunfire Support

DISTRIBUTION:

Figure H-14. Annex D (Fire Support) instructions and format (continued)

ANNEX E (RULES OF ENGAGEMENT) TO OPERATION ORDER NO _____

This annex does not follow the standard five-paragraph format defined for other annexes. This annex should provide the level of detail required to list the rules of engagement and any command requirements to ensure these rules of engagement are transmitted down to the lowest echelons of the command. This annex is not likely to contain any appendixes.

Figure H-15. Annex E (Rules of Engagement) instructions and format

ANNEX F (ENGINEER) TO OPERATION ORDER NO _____

See Figure H-10 for completing this annex. Additional specific items are listed below to ensure inclusion in this annex.

1. SITUATION

a. Enemy forces.

(1) Include a detailed description of enemy engineer assets and known obstacles.

(2) List enemy engineer units, including those organic to maneuver units, as being committed or reinforcing. List all engineer units that can be identified as being committed or reinforcing.

b. Friendly forces.

(1) State the higher headquarters' concept of engineer support.

(2) Provide adjacent units' concept of engineer support.

c. Attachments and detachments. List engineer support resources, attached or under the operational control of the unit by higher headquarters, and any units detached or under the operational control of other headquarters.

2. MISSION

3. EXECUTION

a. Scheme of Engineer Operations (SOEO)—same SOEO used in the supported unit's basic OPORD.

- Provide narrative of mobility and survivability tasks that support the maneuver plan regardless of what unit performs the task. For example, artillery-delivered FASCAM would be addressed in this paragraph.

- Explain *what* the essential mobility and survivability tasks are and how they support the scheme of maneuver.

- Ensure the SOEO corresponds to the maneuver unit's concept of operations. The concept provides the foundation and structure from which engineer operations are modeled. If the operations are phased, the SOEO is also phased, using the same phases. If the supported unit does not use phases, the SOEO uses the same format the supported unit used for its concept of operations.

- Address four areas under each phase in the SOEO—general comments, countermobility, survivability, and mobility. Address each in the order of priority for that particular phase. If there is no support provided in a specific area during a phase, do not mention that area. The support addressed under each phase applies to the mobility and survivability effort that supports a maneuver unit during that phase, no matter when the effort was completed. Address each area as follows:

- General comments: a brief, one-sentence comment about mobility and survivability support for the phase.

- Countermobility: each obstacle belt, in order of its priority, its intent, and which maneuver unit it supports. Provide execution criteria for reserve targets and situational obstacles.

- Survivability: each survivability task and relative location, for example, battle position (BP) or vicinity of an EA, and which maneuver unit is supported.

Figure H-16. Annex F (Engineer) instructions and format (continued)

— Mobility: each mobility task (breaching, marking lanes, providing guides, and maintaining a route), relative location (route or objective), priority of reduction asset used (use plows first, then mine clearing line charge), and which maneuver unit is supported.

b. Tasks to subordinate units. List engineer tasks to be accomplished by engineers supporting maneuver elements (only as necessary to ensure unity of effort). Ensure that the unit level tasks assigned to the engineer organization are included. This paragraph is used to inform subordinate unit commanders of tasks under unit control being done by unit-level forces.

C. Coordinating instructions.

- Include times or events in which obstacle control measures become effective if they differ from the effective time of the order.

- List supported unit PIR that must be considered by subordinate engineer staff officers or that the supported unit requires. List mission reports that the supported unit requires if not covered in the signal paragraph or unit SOP.

- Include explanation of countermobility and survivability time lines, if used.

4. SERVICE SUPPORT

a. Command-regulated classes of supply. Identify command-regulated classes of supply. Highlight supported unit allocations that impact on engineer operations CSR.

b. Supply distribution plan. Establish a Class IV and V (obstacle) supply distribution plan. State method of supply for each class, for each supported unit subordinate element.

- List supply points of linkup points.

- List allocations of Class IV and V (obstacle) by support unit element by obstacle control measure or combination. May summarize in a matrix or table.

c. Transportation.

d. Combat health support.

e. Host nation.

- Include host nation (HN) coordination.

- List type and location of HN engineer facilities, assets, or support.

- List procedures for requesting and acquiring HN engineer support.

- Identify any limitations or restrictions on HN support (for example, HN personnel not authorized forward of PL_____).

5. COMMAND AND SIGNAL

a. Command. Designate the headquarters that controls the effort within work lines on an area basis.

b. Signal.

- Identify communication networks monitored by the unit engineer, if different than SOP.

- Identify critical engineer reporting requirements of subordinates if not covered in SOP.

Figure H-16. Annex F (Engineer) instructions and format (continued)

ACKNOWLEDGE:

	NAME
	RANK
Appendixes:	
1 Engineer Overlay	
2 Environmental Considerations	

Figure H-16. Annex F (Engineer) instructions and format (continued)

ANNEX G (AIR DEFENSE) TO OPERATION ORDER NO _____

See Figure H-10 for completing this annex. Additional specific items are listed below to ensure inclusion in this annex.

1. SITUATION

a. Enemy. See Annex B (Intelligence).

(1) **Terrain.** Identify most likely enemy ingress and egress routes.

(2) **Weather.** Identify enemy aircraft all-weather capabilities and limitations.

(3) **Enemy air capability and or activity.**

(a) **Air threat data.** Air-capable organizations including air platforms by number and type.

(b) **Additional air threat information.** Include air threat information pertinent to the operation but not covered in the Intelligence Annex. Highlight specific air threat considerations such as sortie rates, subordination of air elements to ground units, ordnance peculiarities, target preferences, tactics, and recent significant activities and tactical ballistic missile threat.

(c) **Air avenues of approach.** List all expected air avenues of approach and identify by air platform their potential users. List all beginning points. List all known beginning points and describe avenue of approach as it goes through the area of interest.

b. Friendly situation. List ADA mission at all applicable levels. Describe how the air defense plan integrates with higher-echelon plans.

(1) **Higher units.** Outline higher AD unit concept and plans.

(2) **Adjacent units.** Outline adjacent AD unit concept and plans.

(3) **Supporting elements.** Note supporting units and support relationship.

c. Attachments and detachments. Identify air defense resources attached from other commands and identify those air defense resources detached.

2. MISSION**3. EXECUTION**

a. Scheme of ADA support. Commander's overall ADA plan to include the concept, objectives, and priorities.

b. Tasks to subordinate ADA units. Briefly discuss ADA plan, command and support relationships, and priority of protection.

c. Coordinating instructions. Instructions applicable to two or more subordinate units. Include references to other applicable annexes.

- Weapons control status (WCS) and WCS authority. Include any plans to change WCS.

- Hostile criteria. Basic rules the commander has established to assist in the identification of friendly or hostile air vehicles. Include replanned changes.

- Rules of engagement. Address ROE unique to the operation or points in the operation where changes are intended. Include use of supplemental fire control measures.

Figure H-17. Annex G (Air Defense) instructions and format

- Passive air defense. Specific passive air defense measures that all units should take to protect themselves from air and missile attack or surveillance during this operation.
- Combined arms for air defense. Specific techniques units should use to help in defending themselves against an air or a missile attack or surveillance.
- Early warning. Method and format for passing early warning to the entire force.

4. SERVICE SUPPORT

5. COMMAND AND SIGNAL

a. Command.

b. Signal.

- Identification, friend or foe (IFF) code edition and book number.
- Communications links for early warning equipment.

Figure H-17. Annex G (Air Defense) instructions and format (continued)

ANNEX H (SIGNAL) TO OPERATION ORDER NO _____

See Figure H-10 for completing this annex. Additional specific items are listed below to ensure inclusion in this annex.

1. SITUATION**a. Enemy.**

(1) **Terrain.** Critical terrain aspects that would impact on deployment of communications systems.

(2) **Enemy capability and or activity.** Significant enemy electronic warfare capabilities that impact communications systems.

b. Friendly situation.

- Primary communications gateways providing connectivity to higher, lower, and adjacent units.
- Critical communications security measures required to counter expected enemy EW capabilities and protect C² systems.
- External communications assets that augment capabilities of signal support units.

3. EXECUTION**a. Scheme of signal support operations.**

(1) Describe the concept of signal operations to support the maneuver plan, including primary and back-up systems supporting critical C² networks.

(2) Establish the plan for extending C² systems through each phase of the operation.

(3) List critical links between tactical and strategic communications systems.

(4) Identify critical limitations of organic signal support assets as detailed by the signal plan and define limitations of assets from higher headquarters.

(5) State signal support tasks that all nonsignal units (combat, CS, CSS) must perform to accomplish missions and tasks beyond normal MTOE requirements.

(6) State signal support priorities.

b. Tasks to subordinate units.

- Signal support tasks that specific maneuver elements are to accomplish that the base OPORD does not contain.
- Signal support tasks that signal units supporting maneuver elements are to accomplish only as necessary to ensure unity of effort.
- Army Battle Command System (ABCS) control procedures.

c. Coordinating instructions.

- Critical signal support instructions not already covered in the base OPORD.
- Key times or events critical to information system and network control procedures.

4. SERVICE SUPPORT

Figure H-18. Annex H (Signal) instructions and format

5. COMMAND AND SIGNAL

- a. Identify C² systems control hierarchy for common user network.
- b. Identify local area network control procedures for network administration and/management.
- c. Use appropriate appendixes to diagram any unique changes to standard communications networks for specified operations.

Figure H-18. Annex H (Signal) instructions and format (continued)

ANNEX I (SERVICE SUPPORT) TO OPERATION ORDER NO _____

See Figure H-10 for completing this annex. Additional specific items are listed below to ensure inclusion in this annex.

- 1. SITUATION**
- 2. MISSION**
- 3. EXECUTION**
- 4. SERVICE SUPPORT** (service support matrix and overlay)

- a. Materiel and services.**

(1) Supply. Provide information by class of supply. List maps, water, special supplies, and excess and salvage materiel, as applicable. For each subparagraph, list supply point locations and state supply plan and procedures. Post supply point locations to service support matrix and overlay.

(a) Class I Rations. List ration cycle.

(b) Class II Organizational clothing and individual equipment (OCIE) and maps. Classified map requests are submitted through S2 (G2) channels.

(c) Class III Bulk fuel; Class III package petroleum, oils, and lubricants.

(d) Class IV Construction and fortification material. List command-controlled items.

(e) Class V Munitions. List CSRs and procedures to request explosive ordnance detachment (EOD) support.

(f) Class VI Personal demand items. Health and comfort packs and items normally sold through the exchange service.

(g) Class VII Major end items. List command-controlled items.

(h) Class VIII Medical material.

(i) Class IX Repair parts. State the approving authority for controlled exchange of parts. List critical shortages and command-controlled items.

(j) Class X Material for nonmilitary or civil affairs operations.

(k) Miscellaneous. Miscellaneous items which are not one of the 10 supply classes (such as water, captured material, and salvage material).

(2) Transportation. For each subparagraph, identify facility locations, traffic control, regulation measures, main supply routes (MSRs) and alternate supply routes (ASRs), transportation critical shortages, and essential data not provided elsewhere. Post MSRs, ASRs, and transportation nodes to services support overlay. List transportation request procedures.

(a) Land.

(b) Sea.

(c) Air.

(3) Services. Identify services available, the designation and location of units providing the services, and the time the service will be available. List procedures by type for requesting services. Post services information to service support matrix and overlay.

Figure H-19. Annex I (Service Support) instructions and format

- (a) **Construction.**
- (b) **Showers, laundry, clothing repair (SLCR), and light textile repair.**
- (c) **Mortuary affairs.**
- (d) **Food preparation.**
- (e) **Water purification.**
- (f) **Aerial delivery.**
- (g) **Installation service.**

(4) **Labor.** Include essential information as appropriate.

(5) **Maintenance.** For each subparagraph, include priority of maintenance, location of facilities and collecting points, repair time limits at each level of maintenance, and evacuation procedures. Post maintenance points to service support matrix and overlay.

- (a) **Air.**
- (b) **Ground.**
- (c) **Watercraft.**

b. Medical evacuation and treatment. State plan for collection and medical treatment of sick, injured, or wounded US and joint force soldiers, enemy prisoners of war, and civilians. Discuss support requirements for CHS logistics (including blood management), combat stress control, preventive medicine, dental services, and veterinary services. Post hospital locations and information to service support matrix and overlay.

- (1) **Evacuation.** Medical evacuation policy, including contaminated casualty treatment.
- (2) **Hospitalization.**

c. Personnel. Detail plans for unit-strength maintenance; personnel management; morale development and maintenance; discipline, law and order; headquarters management; force provider; religious support and so on. Post locations and information to service support matrix and overlay.

- (1) **Unit strength maintenance.**
- (2) **Morale.**

d. Foreign nation and host nation support. This can be an appendix to the service support annex.

e. Miscellaneous. Logistics and personnel reports format usually as per SOP or included in an appendix. List any allocation rules in effect.

5. COMMAND AND SIGNAL

ACKNOWLEDGE:

NAME
RANK

Figure H-19. Annex I (Service Support) instructions and format (continued)

- APPENDIXES:**
- 1 Service Support Matrix.
 - 2 Service Support Overlay.
 - 3 Traffic Circulation and Control.
 - Tab A Traffic Circulation (Overlay).
 - Tab B Road Movement Table.
 - Tab C Highway Regulations.
 - 4 Personnel.
 - 5 Legal.
 - 6 Religious Support.

DISTRIBUTION:

Figure H-19. Annex I (Service Support) instructions and format (continued)

ANNEX J (Nuclear, Biological, and Chemical (NBC)) TO OPERATION ORDER NO _____

See Figure H-10 for completing this annex. Additional specific items are listed below to ensure inclusion in this annex.

1. SITUATION. Address enemy NBC threat, to include smoke, flame, and riot control agents.

2. MISSION

3. EXECUTION

a. Scheme of NBC operations. Briefly state the NBC defense operation to be carried out. State smoke synchronization plan.

b. Tasks to subordinate units. Include subordinate and supporting chemical unit tasks, missions, and priorities for NBC reconnaissance, surveillance, and decontamination operations.

c. Coordinating instructions.

(1) MOPP-level guidance.

(2) Automatic masking criteria.

(3) Troop safety criteria.

(4) Locations of linkup points for decontamination sites.

(5) Locations of medical facilities for treating chemical casualties.

(6) Designated turn-in point and procedures for handling of chemical and biological samples.

(7) Civilian and military facilities whose destruction could create militarily significant NBC hazards.

(8) Operational exposure guidance (if applicable).

(9) Procedures for limiting electromagnetic pulse (EMP) effects.

(10) Identification of designated observer units.

(11) Identification of procedures for providing support to local populations.

4. SERVICE SUPPORT

a. Procedures for handling contaminated casualties and processing of remains, if not in SOP. State the battlefield interment authority.

b. Information on the availability and location of field expedient decontamination supplies, materials, and decontaminants.

c. Information about the availability, procedures for distributing, prestock points, and transportation of NBC equipment and chemical defense equipment.

d. Procedures for chemical defensive equipment push package concept.

5. COMMAND AND SIGNAL

a. Command. Location of chemical staffs and subordinate and supporting chemical unit headquarters.

Figure H-20. Annex J (Nuclear, Biological, and Chemical (NBC)) instructions and format

b. Signal.

- Special signal instructions to subordinate and supporting chemical units.
- Information concerning the NBC warning and reporting system (NBCWRS).
- Information concerning dissemination of STRIKWARN messages.

**Figure H-20. Annex J (Nuclear, Biological, and Chemical (NBC))
instructions and format (continued)**

ANNEX K (PROVOST MARSHAL) TO OPERATION ORDER NO _____

See Figure H-10 for completing this annex. Additional specific items are listed below to ensure inclusion in this annex.

1. SITUATION

2. MISSION

3. EXECUTION

a. Scheme of provost marshal operations. State PM concept to employ military police assets. Focus on commander's guidance, mission, and intent, and how this supporting effort contributes to the fight and how it is nested.

(1) Maneuver and mobility support. Outline circulation control plan. Focus on maneuver unit mobility to minimize interference with movement within and through the rear area forward. Include the following:

- Route reconnaissance and surveillance.
- Main supply route regulation enforcement.
- Contamination avoidance.
- Straggler control.
- Dislocated civilian control.
- Tactical and criminal intelligence collecting and reporting.

(2) Force protection. Develop rear area protection plan, to include Levels II and III response actions (base and base cluster defense); assist in developing reconnaissance and surveillance plan. Include—

- Security of critical assets.
- Base response force (Levels I, II, III).
- Counterreconnaissance and response force activities.
- Airbase defense.
- Counterterrorism and antiterrorism activities.
- Area damage control.
- NBC detection and reporting.
- C² protection activities.

(3) Internment and resettlement operations. Determine locations of EPW, detainee, or internee holding areas. Coordinate with appropriate rear area operations center (RAOC) or staff element on population data (such as number and location). Plan and direct operations (collection, detention, internment, protection measures, sustainment, and evacuation). Coordinate with G4 (S4) and host nation as necessary.

(4) Law and order operations. Outline plan to maintain law and order in rear area; forward to maneuver units. Determine investigative assets, develop MP patrol routes, and establish criteria for apprehension and detention of US military prisoners.

Figure H-21. Annex K (Provost Marshal) instructions and format

(5) Police intelligence operations. Outline coordination with Criminal Investigation Division (CID), MP, and MI relative to the collection, integration, and dissemination of police intelligence and information.

b. Tasks to subordinate units. List tasks to be accomplished by units in GS, and specific units if in a DS role.

c. Coordinating instructions. Include instructions on MP GS missions that apply to two or more subordinate units. Refer to other supporting appendixes or annexes (such as Annex N (Rear Operations)), which include elements this annex does not cover in detail.

- State coordination and cooperation among adjacent and other units, and civilian HN agencies that are required to complete the mission, for example, engineer in building and hardening EPW holding area.

- State actions pertaining to rear area force protection that may expand or differ from established SOP.

4. SERVICE SUPPORT

5. COMMAND AND SIGNAL

Figure H-21. Annex K (Provost Marshal) instructions and format (continued)

ANNEX L (RECONNAISSANCE AND SURVEILLANCE) TO OPERATION ORDER NO _____

See Figure H-10 for completing this annex. Additional specific items are listed below to ensure inclusion in this annex.

1. SITUATION

2. MISSION

3. EXECUTION

a. Scheme of support. State the overall reconnaissance objective. State the overall reconnaissance and surveillance plan, with tasks and purposes. Detail how reconnaissance assets operate in relation to the rest of the force. State the method reconnaissance forces will use to get to the assigned area (infiltration, penetration of enemy security zone, passage of lines, and so on). (Refer to reconnaissance and surveillance overlay.)

b. Tasks to subordinate units. Each task to a subordinate reconnaissance or surveillance asset must include the following.

(1) How the unit will get to its assigned area (routes, passage points, and so on).

(2) The reconnaissance objective for the unit.

(3) Specific collection tasks (PIR with indicators) and where to look (NAIs) as identified in the reconnaissance and surveillance plan matrix.

- State when to conduct the reconnaissance and surveillance operation and the time when information is needed.

c. Coordinating instructions.

4. SERVICE SUPPORT

5. COMMAND AND SIGNAL

a. Command

b. Signal

- State whom to report collected information to specifically and on what nets.

- State retransmission plan to support the operation.

Figure H-22. Annex L (Reconnaissance and Surveillance) instructions and format

ANNEX M (DEEP OPERATIONS) TO OPERATION ORDER NO _____

See Figure H-10 for completing this annex. Additional specific items are listed below to ensure inclusion in this annex.

1. SITUATION**2. MISSION****3. EXECUTION**

a. Scheme of support. Explain the overall deep operations plan, with tasks and purposes. Detail how organizational assets committed for deep operations are employed and operating in relation to the rest of the force. Show how intelligence assets are employed either in a primary or support role. Detail how forces committed for these operations get to their assigned areas and return or link up with friendly forces. Detail how fires (lethal and nonlethal) are used to set and support the deep operations plan.

b. Tasks to subordinate units.

(1) Include how the unit will get to its assigned area to participate in or support the operation (routes, passage points, and so on).

(2) Provide the primary objective for the unit or asset.

(3) List specific tasks identified in the overall plan.

c. Coordinating instructions.

4. SERVICE SUPPORT. Configure service support assets to provide flexible and responsive support. CSS planners must understand the intent of the mission and be able to address the following.

- Length of the operation.
- Resupply expected during the operation.
- Resupply and CSS assets available to support the operation.
- Mode of resupply (air or ground).

5. COMMAND AND SIGNAL

a. Command. Cross-FLOT operations require centralized planning and decentralized execution.

b. Signal.

- State whom to report collected information to specifically and on what nets.
- Provide retransmission plan to support the operation.

Figure H-23. Annex M (Deep Operations) instructions and format

ANNEX N (REAR OPERATIONS) TO OPERATION ORDER NO _____

See Figure H-10 for completing this annex. Additional specific items are listed below to ensure inclusion in this annex.

1. SITUATION

2. MISSION

3. EXECUTION

a. Scheme of rear area operations. Identify how the rear operations center will support the higher headquarters' deep and close operations by executing rear operations.

(1) Terrain management. Identify areas to be used for reconstitution, and when the rear boundaries will be moved forward during operations.

(2) Security. Identify the tactical combat force (TCF), response force, and reaction forces. State the counterreconnaissance plan, and how aviation overflights (routine in support of sustainment operations) will be used to provide additional reconnaissance. Identify CI tasks to assist in threat reduction, location, and identification. Plan for integrating any HN, multinational, or joint forces support.

(3) Sustainment. Monitor status of sustainment operations within the command. Identify positioning of support assets. Identify critical CSS facilities and movements that require priority protection. Plan for the establishment of forward supply points.

(4) Movements. Monitor administrative and tactical movements in the rear area. Identify critical choke points that require sustained engineer support. Plan for the rerouting of sustainment on MSR to ensure no interference with the movement of tactical units. Plan for tracking of all units, to include HN, multinational, and joint, moving through the rear area.

b. Tasks to subordinate units, to include tactical combat forces, military police, and base cluster reaction forces.

c. Coordinating instructions.

- Designate responsibilities for specific units to conduct rear area security.
- Specify tasks to units for intelligence gathering, liaison, response operations, base and base cluster self-defense, and rear area fire support.
- Specify tasks to rear CP for coordinating rear operations to include planning and conduct of rear security operations.

4. SERVICE SUPPORT

5. COMMAND AND SIGNAL

a. Command.

(1) Identify rear operations commander, establish chain of command for the rear CP, identify base and base cluster commanders, and their chain of command.

(2) Designate the location of the alternate rear CP.

b. Signal.

Figure H-24. Annex N (Rear Operations) instructions and format

ANNEX O (AIRSPACE COMMAND AND CONTROL) TO OPERATION ORDER NO _____

See Figure H-10 for completing this annex. Additional specific items are listed below to ensure inclusion in this annex.

1. SITUATION. Include information affecting AC² that is not included in paragraph 1 of the operations order and Annex G (Air Defense) or that requires expansion.

a. Enemy.

(1) Enemy capability and activity.

(a) List known and templated ADA locations and enemy air corridors.

(b) List significant enemy maneuver capabilities that affect AC² operations such as radio combat capabilities.

b. Friendly situation. Note additional airspace users, including Air Force, Navy, Marine, coalition ADA, FA, and UAV that affect the scheme of maneuver.

2. MISSION

3. EXECUTION

a. None.

b. None.

c. Coordinating instructions.

- Identify routes and corridors (such as minimum-risk routes, LLTRs, standard-use routes, UAV operating areas, restricted operations zones (ROZs), Air Force routes, and coordination requirements).
- Identify fire support coordination measures that affect airspace users.
- List areas of large area smoke operations.

4. SERVICE SUPPORT

5. COMMAND AND SIGNAL

Figure H-25. Annex O (Airspace Command and Control) instructions and format

ANNEX P (COMMAND AND CONTROL WARFARE) TO OPERATIONS ORDER NO _____

See Figure H-10 for completing this annex. Additional specific items are listed below to ensure inclusion in this annex.

1. SITUATION

a. Enemy. Identify relevant enemy C² nodes in the commander's AO and the vulnerability of those nodes.

b. Friendly situation. Identify friendly C² nodes and their vulnerability, and the assets to defend those nodes. Identify assets to attack enemy C² nodes.

2. MISSION**3. EXECUTION**

a. Scheme of support. State the C²W concept of support to the operation. Include a discussion of the overall C²W operation, with the specific details in appendixes. This annex should contain the information to coordinate, deconflict, and synchronize each of the components of C²W.

(1) Military deception. Identify what organic and assigned assets can accomplish, and what support is required from organizations or agencies external to the command. Coordinate, deconflict, and synchronize this component with the other four components. Annex S, Deception Plan, is approved by the commander two echelons higher than written and supports that commander's deception plan. Annex S is provided on a "must know" basis.

(2) EW. State the EW mission, enemy EW capabilities, defensive and offensive EW measures, and coordination with other parts of the OPLAN. Identify target sets and effect, by priority, for EW operations. Clearly identify what organic and assigned assets can accomplish, and what support is required from organizations or agencies external to the command. Coordinate, deconflict, and synchronize this component with the other four components. Refer to Annex T, Electronic Warfare, for detailed information.

(3) OPSEC. Deny the enemy information concerning the speed and size of the US buildup, as well as the specific course of action the United States will execute in the decisive combat phase. Emphasis in initial stages is on denying the enemy access to his own or foreign intelligence capabilities. Identify target sets and desired effect, by priority, for OPSEC. Coordinate, deconflict, and synchronize this component with the other four components. Refer to Annex Q, Operations Security, for detailed information.

(4) PSYOP. Identify, in support of C²W, the audiences and key communicators, and desired effect, by priority, for PSYOP efforts. Clearly identify what organic and assigned assets can accomplish, and what support is required from organizations or agencies external to the command. Coordinate, deconflict, and synchronize this component with the other four components. Refer to Annex R, Psychological Operations, for detailed information.

(5) Physical destruction. When employed in a C²W role, use physical destruction to destroy the enemy's communication, integrated air defense system, and intelligence collection and fusion capabilities and to destroy the enemy's ability to strike at friendly C² and C²W capabilities. Identify target sets and effect, by priority, for EW operations. Clearly identify what organic and assigned assets can accomplish, and what support is required from organizations or agencies external to the command. Coordinate, deconflict, and synchronize this component with the other four components. Refer to Annex D, Fire Support, for detailed information.

Figure H-26. Annex P (Command and Control Warfare) instructions and format

- b. **C²W tasks.** Review specific and implied tasks by command.

NOTE: Include in appendixes any additional information needed to further clarify missions and tasks. An appendix may include a C²W synchronization matrix.

4. SERVICE SUPPORT

5. COMMAND AND SIGNAL

Figure H-26. Annex P (Command and Control Warfare) instructions and format (continued)

ANNEX Q (OPERATIONS SECURITY) TO OPERATION ORDER NO _____

See Figure H-10 for completing this annex. Additional specific items are listed below to ensure inclusion in this annex.

1. SITUATION

2. MISSION

3. EXECUTION

a. Scheme of operational security programs and actions.

- State the OPSEC mission including the concept for the conduct and control of OPSEC. Describe phased operations where applicable and describe how OPSEC will ensure the accomplishment of the commander's intent and end state vision.

- List the OPSEC tasks not listed in the base OPORD to be performed by maneuver elements. Ensure maneuver units implement the appropriate program against the current threat.

- List the countermeasures to be taken by the unit to ensure enemy collection efforts are unsuccessful.

- List countermeasures and counterintelligence methods, assets, and programs of special importance to operations. Include personnel security, physical security, COMSEC, SIGSEC, patrolling, or counterreconnaissance, for example, efforts are aimed at both external and internal security threats.

b. Tasks to subordinate and supporting units. List countermeasures that specific units are to implement. List the countermeasures that require special emphasis by assigned, attached, or supporting units. These countermeasures are designed to counter a specific enemy intelligence threat.

4. SERVICE SUPPORT

5. COMMAND AND SIGNAL

Figure H-27. Annex Q (Operations Security) instructions and format

ANNEX R (PSYCHOLOGICAL OPERATIONS (PSYOP)) TO OPERATION ORDER NO _____

See Figure H-10 for completing this annex. Additional specific items are listed below to ensure inclusion in this annex.

1. SITUATION

a. Enemy. State enemy resources and capabilities, both military and civilian, to conduct PSYOP. State past enemy PSYOP efforts (who was targeted, using what means, and their effectiveness).

b. Friendly.

c. Attachments and detachments.

2. MISSION**3. EXECUTION**

a. Scheme of psychological operations. Address how PSYOP efforts are centrally orchestrated and managed by the supporting psychological operations task force (POTF) and the commander's role in the decentralized execution of higher headquarters' PSYOP programs.

b. Tasks to subordinate units. Ensure tasks clearly fix responsibilities and provide feedback on effectiveness of PSYOP activities.

c. Coordinating instructions.

- Identify National Command Authorities (NCA)-approved PSYOP objectives, themes to stress, and themes to avoid (or refer to appropriate appendix).

- Identify target audiences in the AO to include key communicators. Identify relevant background information on target audience perspectives, vulnerabilities, effectiveness, and susceptibility to friendly and enemy PSYOP (or refer to appropriate appendix).

- Identify military activities and actions conducted by subordinate units that support or facilitate PSYOP efforts (or refer to appropriate appendix).

- Provide OPSEC guidance on PSYOP sensitivity and employment.

- State classification authority for PSYOP activities.

- Address mechanisms for coordinating PSYOP with attached PSYOP support elements, assigned PSYOP staff, and other informational activities operating in the commander's AO.

- State procedures for coordinating fixed-wing, rotary-wing, UAV, and field artillery delivery of PSYOP products.

- State PSYOP-specific current intelligence requirements (or refer to appropriate appendix).

4. SERVICE SUPPORT

a. Command-regulate classes of supply.

b. Supply distribution plan. Discuss provisions for control and maintenance of PSYOP-unique supplies and equipment to include PSYOP products.

5. COMMAND AND SIGNAL

a. Command

- Explain command relationships between attached PSYOP forces and the POTF elements operating in the AO, the unit, and the supporting POTF.

Figure H-28. Annex R (Psychological Operations) instructions and format

- State the PSYOP approval and release authority that has been delegated or retained by higher headquarters.
 - State the PSYOP approval authority the commander has delegated or specifically retained to subordinate commanders for the development of proposed PSYOP products, actions, and programs.
 - State the PSYOP release authority the commander has delegated, or specifically retained, to subordinate commanders for releasing and disseminating approved PSYOP products in their respective areas of responsibility.
- b. Signal.** Identify and explain unique PSYOP-related acronyms and abbreviations.

Figure H-28. Annex R (Psychological Operations) instructions and format (continued)

ANNEX S (DECEPTION) TO OPERATION ORDER NO _____

See Figure H-10 for completing this annex. Additional specific items are listed below to ensure inclusion in this annex.

1. SITUATION**2. MISSION****3. EXECUTION****a. Scheme of deception programs and actions.**

- State the deception concept (target and story) including the concept for the conduct and control of the deception operation. Describe phased operations where applicable and describe how the deception plan will ensure the accomplishment of the commander's intent and end state vision.

- List the deception operation tasks not listed in the base OPORD to be performed by maneuver elements. Ensure maneuver units implement the appropriate program against the current threat.

- List the countermeasures to be taken by the unit to ensure enemy collection efforts are unsuccessful at exposing the deception operation.

- State the objectives of the deception plan and the enemy collection and analysis mechanisms and means the plan will target. State what phases of the operation the deception measures are implemented in and which countermeasures and counterintelligence methods, assets, and programs are of special importance to operations.

b. Tasks to subordinate and supporting units. List tasks to subordinate units that support the deception operation. Include in the tasks description the cover story and description of how the tasks support the overall deception plan. Include also what enemy observation measures the tasks are intended to target.

c. Coordinating instructions. State the coordination of two or more units during specific deception tasks. State what data is to be collected on enemy forces to exhibit success or failure of the deception operation.

4. SERVICE SUPPORT**5. COMMAND AND SIGNAL**

Figure H-29. Annex S (Deception) instructions and format

ANNEX T (ELECTRONIC WARFARE) TO OPERATION ORDER NO _____

See Figure H-10 for completing this annex. Additional specific items are listed below to ensure inclusion in this annex.

- 1. SITUATION.** Detail enemy electronic capabilities, communications, noncommunications, and radio-electronic combat systems. (NOTE: These may be provided in appendixes to the annex.) Outline the higher headquarters' EW plan with any additional EW assets or resources supporting the unit.
- 2. MISSION**
- 3. EXECUTION.** State the proposed EW and electronic combat operations. Establish priorities.
- 4. SERVICE SUPPORT**
- 5. COMMAND AND SIGNAL**

Figure H-30. Annex T (Electronic Warfare) instructions and format

ANNEX U (CIVIL-MILITARY OPERATIONS) TO OPERATION ORDER NO _____

See Figure H-10 for completing this annex. Additional specific items are listed below to ensure inclusion in this annex.

1. SITUATION. Include information affecting CMO operations not included in the OPORD or OPLAN. Identify the impact of civilians on unit ability to complete its mission. Identify higher and adjacent unit CMO plans. Identify CA resources attached and detached with effective times.

2. MISSION

3. EXECUTION. State the proposed CA operations. Establish priorities. Define unique requirements for liaison, particularly with agencies outside the normal Army channels (for example, Department of Defense, Department of State, and nongovernment organizations).

4. SERVICE SUPPORT

5. COMMAND AND SIGNAL

a. Command.

b. Signal. Designate the reporting functions for the various units and CMO activities.

Figure H-31. Annex U (Civil-Military Operations) instructions and format

ANNEX V (PUBLIC AFFAIRS TO OPERATION ORDER NO _____)

See Figure H-10 for completing this annex. Additional specific items are listed below to ensure inclusion in this annex.

- 1. SITUATION.** Include information affecting public affairs (PA) operations not included in the OPORD or OPLAN. Identify the impact of media and news technology on unit ability to complete its mission. Identify any higher and adjacent unit PA plans. Identify PA resources and news media attached and detached with effective times.
- 2. MISSION**
- 3. EXECUTION.** State the proposed PA operations. Establish priorities. Define unique requirements for media liaison, particularly with any foreign news agencies.
- 4. SERVICE SUPPORT**
- 5. COMMAND AND SIGNAL.** Designate the reporting functions for the various PA activities.

Figure H-32. Annex V (Public Affairs) instructions and format

OPERATION ORDER VIGNETTE

The following order, Field Order 18, represents a typical order seen during the continuing operations of US Army forces in WWII. Field Order 18 was completed under a time-constrained environment with proven SOPs. This order uses an overlay order with additional mission orders provided personally by the commander.

VII Corps, commanded by MG (later GEN) J. Lawton "Lightning Joe" Collins, had to expand the Remagen Bridgehead as well as plan for the breakout and exploitation into the German industrial heartland. VII Corps had prepared, and the CG had given the order orally on 22 March, following up on the 23d with a written order, including overlay, intelligence annex, and fire support annex. The order, both the oral and written, left sufficient flexibility for adaption from the time of its issue until its execution.

Especially notable is the brevity and simplicity of the basic order. Such simplicity and brevity reflect the combat-tested experience and SOPs of VII Corps and the divisions within First US Army.

Field Order 18 contains the minimum essential information by today's doctrine for an OPORD:

1. Five basic paragraphs (slightly different from now, but nevertheless similar in name and order).
2. Task organization (found in subparagraphs of paragraph 3 rather than between paragraphs 2 and 3 as per the 1940 format).
3. Mission statement (paragraph 2).
4. An operations overlay.

MG Collins used oral orders and an overlay to issue his order, with the written order confirming those directives. Today a commander's intent and concept of the operation are mandatory. In Field Order 18, a concept is perceived in the subparagraphs of paragraph 3 and, presumably, the corps commander issued his concept in the oral orders. It is apparent from the execution of the operation that the subordinates understood MG Collins' concept.

D-day and H-hour for Field Order 18 were at 0400 hours, 25 March 1945. The Corps accomplished its initial objectives by 26 March, seized the Corps objective by 27 March, and exploited to Marburg on 28 March. The Corps issued a subsequent field order (FO 19) on 28 March for follow-on operations. These eventually involved closing the Ruhr Pocket with XIX Corps from Ninth Army to the north on 1 April 1945, after covering 300 kilometer in seven days, with over 300,000 German soldiers in the pocket. During the European campaign, VII Corps issued only 20 field orders, or an average of two per month, to control operations; many of these "confirmed oral orders CG VII Corps."

HQ, VII CORPS
APO 307
23 MARCH 1945

FO 18 (Confirming oral orders CG VII Corps issued 22 March 1945)

Maps: GSGS 4416 CENTRAL EUROPE 1/100,000

1. a. See Annex 2, Intelligence.

b. (1) NINTH US ARMY, with XIX Corps on its right, continues its defense of the RHINE River from WORRINGEN (F3874) (excl) to the NORTH.

(2) FIRST US ARMY will attack on D-day from present bridgehead area to drive EAST between the SIEG River on the NORTH and the LAHN River on the SOUTH to capture the road center at LIMBURG (M2398), and the high ground extending generally NORTH thereof.

2. a. VII Corps will (1) attack at H-hour, D-day within zone of action EAST of the RHINE and SOUTH of the SIEG River to capture the high ground generally WEST of the DILL River between WURGENDORF (G2740) and NENDEROTH (G3220); (2) be prepared to resume the attack to the NORTHEAST; (3) maintain defense of the WEST bank of the RHINE in the Corps zone and NORTH of BONN (F5537); and (4) protect the left flank of the FIRST ARMY EAST of the RHINE.

b. For Corps and Division boundaries and initial objectives, see Annex 1, Operations Overlay.

c. H-hour and D-day to be announced.

3. a. 3d Armored Division, Major General Maurice Rose, Commanding.

(1) Attachments:

414th Inf (104th Inf Div)
183d FA Bn (155 How)
83d Armd FA Bn (105 How SP)
486th AAA AW Bn (SP)
703d TD Bn (SP)

NOTES:

MG Collins used oral and overlay techniques for delivery of order

1. Annex 2 not included; consisted of main body (3 pp) and 2 appendixes: App 1, Counterintelligence (2 pp); App 2, Tactical Study of the Terrain (2 pp)

2. MISSION

Operation commenced 250400MAR45 following crossing of Rhine to north by 21 Army Group

Technically this is an OPLAN IAW current doctrine (see Operations Overlay.)

Doctrinal location (1944) for task organization (between paras 2 and 3)

In this case, task organization is included in para 3 for subordinate units.

3. TACTICAL MISSIONS FOR SUBORDINATE UNITS

Implied concept: 3 AD pass through IDs; Seize Corps objectives in order.

Initial objectives taken 2d day, DILL River crossed on 3d day.

Figure H-33. VII Corps operation order (WWII)

(2) Will attack H-hour D-day through elements of the 104th Division and 1st Inf Div and advance rapidly to seize initially the high ground and road center in the vicinity of ALTENKIR-CHEN (F9332) and successive objectives thereafter to include crossings of the DILL River between DILLENBURG (G3837) and HERBORN (G3931).

See next two subparas: Infantry divisions following to clear enemy forces.

(3) Will by-pass [sic] pockets of resistance in order to seize objectives quickly.

(4) Will be prepared to exploit in the direction of MARBURG (G7347) - FRANKENBERG (G7473).

VII Corps/3 AD exploited to MARBURG on 4th day.

b. 104th Infantry Division, Major General Terry Allen, Commanding.

(1) Attachments:

555 AAA AW Bn (M)
750th Tk Bn
Co. C, 644th TD Bn (SP)

(2) With its principal effort on the left, will attack at H-hour on D-day to eliminate all enemy resistance within its zone of action.

(3) Will assist the advance of 3d Armd Div.

c. 1st Infantry Division, Brigadier General Clifton Andrus, Commanding.

(1) Attachments:

957th FA Bn (155 How)
193d FA Bn (25 Pdr)
103d AAA AW Bn (M)
634th TD Bn (SP)
745th Tk Bn
Co A, 86th Cml Bn

(2) With its principal effort on the right, will attack at H-hour on D-day to eliminate all enemy resistance within its zone of action.

(3) Will assist the advance of 3d Armd Div.

(4) Will protect the NORTH flank of the Corps within its zone.

Figure H-33. VII Corps operation order (WWII) (continued)

(5) Will be progressively relieved of responsibility for protecting the NORTH flank of the Corps by elements of 78th Inf Div and the 4th Cav Gp per par 3d(3) and par 3g below.

d. 78th Infantry Division, Major General Edwin P. Parker, Jr., Commanding.

- (1) Attachments:
76th FA Bn (25 Pdr)
893d TD Bn (SP)
774th Tk Bn
552d AAA AW Bn (M)
Co B, 86th Cml Bn

(2) Will protect the left flank of the Corps along the SIEG from the RHINE River to the EAST, relieving elements of the 1st Inf Div along the SIEG River initially as far as MERTEN (F7640) as the attack of the 1st Inf Div progresses.

e. 8th Infantry Division, Brigadier General Bryant E. Moore, Commanding.

- (1) Attachments:
69th Div Arty (-879th FA Bn (105 How))
445th AAA AW Bn (M)
644th TD Bn (SP) (-Co C)

(2) Will continue to secure the WEST bank of the RHINE River between F383754 and F535410, preventing the passage of any enemy across the river and maintaining observation over the entire sector.

(3) Will be relieved by 86th Inf Div and assemble in Corps reserve on order CG VII Corps.

f. 86th Infantry Division, Major General Harris M. Melasky, Commanding.

Will relieve 8th Inf Div in its zone and take over the mission of securing the WEST bank of the RHINE River in its zone, preventing the passage of any enemy across the river and maintaining observation over the entire sector.

Figure H-33. VII Corps operation order (WWII) (continued)

g. 4th Cavalry Group, Colonel John C. McDonald, Commanding.

(1) Attachments:

4th Cav Sq
24th Cav Sq
759th Lt Tk Bn (-Co B)
Co A, 298th Engr C Bn

(2) Will assemble by 25 March in vicinity of BONN (F5537) in corps reserve.

(3) Will be prepared to defend the NORTH flank of the Corps along the SIEG River EAST of MERTEN (F7640) on order CG VII Corps, progressively relieving elements of 1st Inf Div as the attack advances.

h. VII Corps Artillery.

VII Corps Artillery will support the attack as per Annex 3, Artillery.

i. VII Corps Engineers.

Corps Engineer troops support the operation; 1120th Engr C Gp in the zone of 104th Inf Div with one battalion in support of the Div; 1106th Engr C Gp in the zone of 1st Inf Div with one battalion in support of 1st Inf Div and one battalion in support of 3d Armd Div.

j. Air Support will be provided for the operation by fighter-bombers and medium bombers of IX TAC and IX Bomb Div of NINTH AIR FORCE.

(1) No vehicles will be parked on main roads at any time.

(2) Commanders will insure that main traffic routes are cleared of road blocks and rubble and that important traffic is not impeded by halted columns.

4. Administrative Orders 114, 115, and 116.

5. a. (1) Current SOI.

(2) Units not in contact with the enemy or not deployed in a defensive role will maintain radio silence except in case of emergency operational requirements.

4. ADMINISTRATIVE

Orders included Supply, Evacuation, Traffic, Service Troops and Trains, Personnel, and miscellaneous paras.

Figure H-33. VII Corps operation order Vignette (WWII) (continued)

b. Initial Command Posts:

VII Corps KONIGSWINTER (F617310)

1st Inf Div	F658307
8th Inf Div	WEIDEN (F362606)
78th Inf Div	NDR HOLTORF (F610375)
86th Inf Div	to be reported.
104th Inf Div	HONNEF (F649272)
3d Armd Div	HONNEF (F649272)
4th Cav Gp	BONN (F553372)

/s/ J. Lawton Collins
/t/ J. LAWTON COLLINS
Major General, U.S. Army,
Commanding

Figure H-33. VII Corps operation order (WWII) (continued)

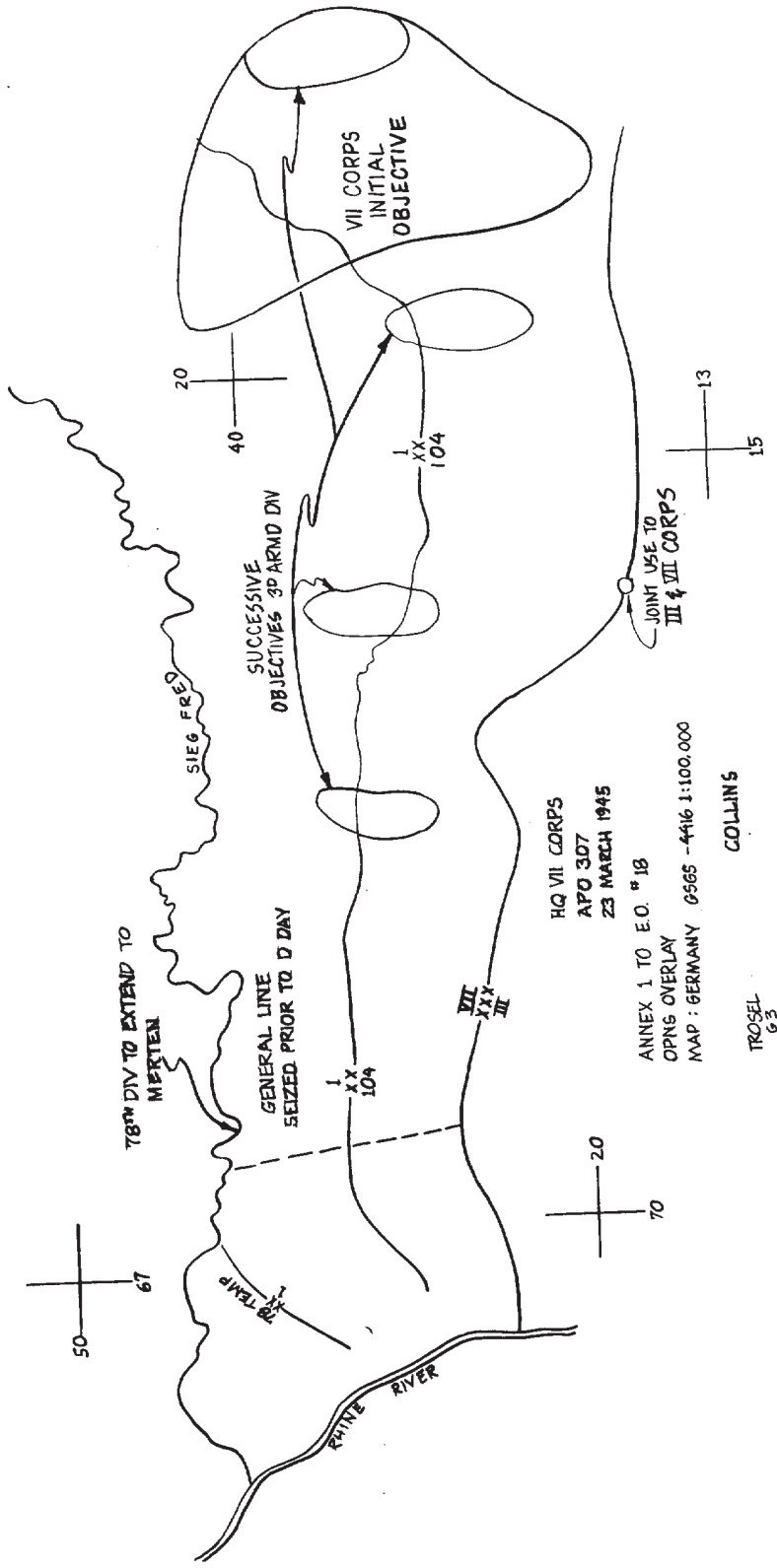

Figure H-33. VII Corps operation order (WWII) (continued)

Appendix I

INFORMATION MANAGEMENT

Proper information management ensures that the commander receives the information he needs to make timely key decisions. A staff officer must maximize the use of information systems to keep the commander from being overwhelmed by information. To do this, the staff officer must understand the characteristics of information and its management.

INFORMATION AVAILABLE TO THE COMMANDER

Information management narrows the gap, as much as possible, between the information the commander requires and the information available to him. All information that commands produce has one overriding purpose—to enable the commander to make timely decisions during the fog of battle. All information must be reliable and the staff must ensure it is verifiable. The commander seeks a dynamic battlefield visualization that will lead him to understand what actions the force requires to produce success. His visualization includes military, political, and psychological considerations.

Depending on the mission and situation, the major components of the commander's visualization are based on METT-T factors. Through his intent, he conveys his visualization to subordinate commanders, the staff, and units. (See Commander's Intent, Chapter 5.)

The meaning of any information the commander gains drives how he visualizes the operation. The manner in which gained information fits into the commander's visualization determines its value. (See TRADOC Pamphlet 525-70.) Staff members must understand the commander's vision and intent if they are to support the commander's information needs.

Army operations produce tremendous volumes of information. Much of this information is useful, but not pertinent, to the commander during decision making. Commanders and staffs who understand this can avoid potential information overload by using effective systems to accurately and rapidly convey necessary information.

In effect, the demands of modern warfare compel commanders to train their staffs and subordinates to be effective information managers and to understand the

complexity of information management. The commander can help his staff gather necessary information and preclude duplicating effort or gathering unnecessary information by focusing the staff through his intent, guidance, and briefbacks.

THE MILITARY INFORMATION SYSTEM

Categories of Information

Information provides a basis for decision making. The Army uses three traditional designations for the various types of information—critical, exceptional, and routine.

Critical Information

Critical information directly affects the successful execution of operations. The commander's critical information requirements (CCIR) include information the commander requires that directly affects his decisions and dictates the successful execution of operations. The CCIR are—

- Applicable only to the commander who specifies it.
- Directly linked to present and future tactical situation.
- Situation-dependent.
- Events or activities that are predictable.
- Specified by the commander for each operation.
- Time-sensitive information that must be immediately reported to the commander, staff, and subordinate commanders.
- Always included in an OPORD or OPLAN.
- Transmitted by a communications system specified in the SOP.

Determining the CCIR helps the commander reduce the amount of information reported to him to what is important and what is urgent to mission accomplishment. The answers acquired from CCIR communicate previously unknown information the commander might need or might consider critical to determine or validate a course of action. They ensure that the information the

commander receives is meaningful and readily recognized as critical to his battlefield visualization.

The *commander* alone decides what information he deems to be critical, based on his experience, the mission, input from his staff, and the higher echelon commander's intent. Two means for deriving the CCIR are war gaming and the production of a decision support template.

The CCIR are expressed as three types of information requirements:

- Priority intelligence requirements (PIR).
- Friendly forces information requirements (FFIR).
- Essential elements of friendly information (EEFI).

NOTE: See also Chapter 5 of this manual. For definition of these types of information requirements, see FM 101-5-1

The information manager, designated by the commander, is normally the CofS (XO). He outlines and monitors the staff's performance and responsibilities in processing information to support the operation and flow that feeds the commander's requirements. He collects, tasks, analyzes, and presents the CCIR in a timely and accurate manner.

During operations, the information manager ensures that a staff member is tracking the CCIR during a designated shift period. That staff member must understand the requirements, review incoming and outgoing information traffic, and understand procedures for informing the commander and designated staff officers of critical information. Units must establish CCIR procedures in unit SOPs and train staffs in these procedures.

The commander must review his critical information requirements for each operation based on METT-T factors. He then adjusts his requirements as situations change.

Exceptional Information

Exceptional information is specific and immediately vital information that directly affects the success of the current operation. Unlike critical information, exceptional information is neither published nor explicitly stated; rather, it must be recognized as vital by tactically and technically competent subordinates and staffs.

Exceptional information signals the occurrence of one or more unpredictable, extraordinary events, such as an unforeseen opportunity for success or an

early warning of a pending emergency. Exceptional information is—

- Unexpected, unplanned, and situation-dependent.
- An immediate priority for command and staff action; the commander and staff must address exceptional information before the operation can continue.
- Extremely time-sensitive in terms of decision making; there can be no delays in transmission.
- Transmitted directly to the commander in as near real time as possible by whatever means is immediately available.
- Applicable to both the friendly and enemy situations.

Routine Information

Routine information is standard, repetitive information that occurs during day-to-day operations. It is made routine by SOP. However, some routine information might cross over to become CCIR (for a specific operation). Routine information—

- Should be used within and between staffs with little commander involvement.
- Is used to prepare and verify estimates.
- Helps identify and anticipate potential problem areas.
- Allows the staff to resolve routine matters, using their own initiative.
- Is not time-sensitive in terms of decision making.
- Does not directly affect the execution of operational or tactical operations.
- Is not essential to the commander in its current raw format and, therefore, must be thoroughly analyzed before being transmitted to reduce overload on the staff and information system.
- Is specified in the unit's SOP, prescribing the sequence, time (or completion of an activity), and format of the information.
- Is normally transmitted via predetermined channels (also specified in the SOP), exchanged between units, and handled staff-to-staff.

Channels

Operational information normally moves throughout the command along specific channels. Channels help

streamline information distribution by ensuring the right information is passed in a timely manner to the right person. There are three channels through which commanders and their staffs communicate—command channels, staff channels, and technical channels:

- The *command channel* is the direct chain-of-command link that commanders, or authorized staff officers, use for command-related activities.

- The *staff channel* is the staff-to-staff link between headquarters. The staff uses the staff channel for control-related activities and to coordinate and transmit planning information, controlling instructions, and other information to support command and control, such as the intelligence operations net or the administrative logistics net.

- The *technical channel* is the technical link between two similar commands within a larger command. Technical channels are typically used to control CS- and CSS-related activities the larger organization requires, such as in the fire direction net, the forward area air defense (FAAD) command and control intelligence (C²I), and so on.

Information Presentation

Desirable characteristics of all information include utility, accuracy, clarity, brevity, coherence, objectivity, and veritability. There are three ways to present information—through written or verbal narrative reports or through graphic displays. Written information must conform to established formats for reports, estimates, and staff studies. Verbal information must conform to established formats for information, decision, mission, or staff briefings.

NOTE: See unit SOP for report formats, Appendix C for staff estimate formats, and Appendix D for staff study formats. See Appendix E for verbal briefing formats.

Graphic displays (maps or charts) visually represent current or future operational information. When possible, commanders and staffs can graphically portray quantifiable information using standard formats, using either automated or manual means. Graphic information should—

- Display symbols, graphics, and terminology consistent with FM 101-5-1.
- Display essential information.
- Display information clearly and understandably.

- Display information accurately, reliably, and in a timely manner.
- Be able to be changed promptly and easily as the information is updated.
- Be rapidly distributed to higher, lower, and adjacent units.

Information Impediments and Solutions

Every commander wants to make the right decision, and he wants to be certain he has the best information possible before he makes a decision. He expects the information to be accurate, valid, reliable, timely, and clearly and directly stated. He also expects subordinates to distribute information among his staff, subordinate commanders and, as appropriate, with higher headquarters.

The staff wants to prepare the best information possible to optimize the commander's decisions. In meeting this goal, however, the staff could actually impede information flow by trying to ensure perfection.

Information management can contribute to a higher headquarters' over-control of subordinate headquarters, especially during high-tempo operations, if it demands perfect or near-perfect information rather than the best available information at any critical time. When this occurs, the higher commander's control becomes dysfunctional, thereby inhibiting the independent command of subordinates.

Commanders who demand or allow their staffs to demand perfect information will be more vulnerable to defeat through the loss of initiative. Demands for perfect information can result in—

- Diverting subordinate units' efforts from mission activities to supporting the higher headquarters' information-reporting system.
- A reporting system overflow, inundating the higher headquarters' staff with information it cannot effectively sort, analyze, or distribute in time to be useful to the command.
- Getting information that is current but without sufficient analysis to help the commander with decision making, or information that is comprehensive but out-of-date and not reflective of the true situation.
- The commander having to delay decisions or frequently review previous decisions while the staff gathers better or more recent data.

- Subordinates who are more likely to defer their actions until their seniors direct them.
- All leaders having less confidence in the higher headquarters' plan and in each other's ability to effectively execute the plan.

Central to effective information management is a good reporting system. The reporting system is based on information relevant to both higher and lower headquarters. Reports should demand only that information important to the organization receiving the report. Reports should support the decision-making process and the execution of operations. Limiting reporting to essential information reduces the amount of time and effort a subordinate must spend on collecting, analyzing, formatting, and transmitting reports.

Supplementing the reporting system with liaison personnel who actively seek the commander's critical information requirements as well as exceptional information saves subordinate units time, effort, and distraction from current operations. Liaison officers can also provide the higher commander with information more quickly, and that information will be considerably more accurate and precise.

The commander bases his information-management system on—

- His degree of willingness to cope with uncertainty.
- The information he wants to make decisions.
- Use of mission orders to task subordinate commanders.
- Effective task organization.
- Use of liaison officers.
- Fostering of informal communications networks.
- Information presentations that have self-explanatory and meaningful contexts.

Information Management Resources

There are three ways to implement the decentralized information management philosophy.

Reports by Exception

The command center displays or retrieves only information that directly contributes to the commander's critical decision making. The commander's critical information requirements should always consist of information that, in part, answers PIR, EEFI, and FFIR

questions; implements decide, detect, and deliver; and assesses methodology and decision points. The commander's principal subordinates (deputy or assistant commanders, CofS (XO), coordinating staff principals, and subordinate commanders) must know his CCIR. In turn, subordinates must coordinate the CCIR with their own functional areas of responsibility.

Commanders and staffs must request only information critical for a decision and refrain from seeking or being distracted by nonessential information. This allows the staff time to coordinate, integrate, and synchronize activities and units. It also supports command and control by minimizing constant interruptions or diversions to run down nice-to-know or just-in-case information.

To reduce the amount of information arriving at command posts, units can send reports forward *by exception*. This ensures that decision makers receive only the most critical information. Labeling information *by exception* also ensures that the critical information gets noticed rather than becoming lost among noncritical information. (Another way to reduce the volume of data arriving at the command post is for the sender to first analyze the information and forward only the analysis.)

Charts and Maps

Charts and operations maps aid in the display of information within a command post. There are two types of charts—narrative (text) and pictorial (symbols or colors). Narrative charts, such as a mission chart, require words to convey their meanings. Color-coded pictorial charts use decision graphics to reflect the current status of a unit or combat, CS, or CSS system. Gumball charts expand the detail that combat-effectiveness charts show.

NOTE: FM 101-5-1 contains a description of these charts.

To correctly interpret a combat-effectiveness graph, viewers must remember the significance of the symbols that represent effectiveness. They must also remember the significance of selected information (personnel, ammunition, weapons systems, and POL). The combat-effectiveness chart is difficult to keep accurate in manual systems because its physical design inhibits easy, rapid, or frequent changes.

The gumball chart can rapidly present each unit's or weapons system's combat capability status through established color codes. Color codes allow the staff to focus on solving or continuing to solve critical problems

rather than less critical ones. If the commander requests further information, he can retrieve (pull) it from the submitting staff section, major subordinate command, or maneuver control system in automated systems. This technique uses the routine information category, passing information through staff or technical channels. However, when the priority is high, or the capability is significantly degraded, the requested information will change from routine to exceptional.

To use the gumball-chart technique, the staff must first establish the color codes each echelon will use. Different elements of the same function use the same color code to avoid confusion at higher headquarters where the staff must analyze and consolidate similar reports from several units.

Currently, color code criteria for maneuver control systems are—

- Green (80 percent or greater combat capability remains).
- Amber (from 60 percent to 79 percent combat capability remains).
- Red (from 40 percent to 59 percent combat capability remains).
- Black (39 percent or less combat capability remains).

Operations maps contain only the minimum-essential information to allow the commander to see the battlefield. Recording excessively detailed information is time-consuming and dramatically interferes with coordination, integration, and synchronization functions. Staff section maps should follow these same guidelines, but they can have more detail because they must display the friendly situation and their respective proponent interests, tracking units, and activities two echelons down.

Critical information for the commander is posted in the unit's command center. The command center supports the commander's ability to see (visualize) the battlefield to assist him with decision making. The effectiveness of the command center relates directly to the type and quality of information used for decision making. The information in the command center should, as a minimum, answer the following questions:

- What is the enemy doing now?
- What are the enemy's capabilities within the next time period? The time period varies based on echelon of command.

- Where is the enemy vulnerable?
- What will the enemy's key decisions be, and how do we want to influence them?
- What does the enemy see as the current friendly activity?
- How does the enemy perceive friendly capabilities within the next time period? The time period varies based on echelon of command.
- What does the enemy see as friendly vulnerabilities he can exploit?
- What is the friendly flank situation?
- What combat power do friendly forces have? In the next time period? The time period varies based on echelon of command.

Charts and tactical maps display critical information within the command center. They reflect an easily understood and continuously visual estimate of the total operational situation for both current and future operations. The proponent staff element is responsible for changes to the command post map and status boards.

The staff must keep the charts on the information display to an absolute minimum. The commander's critical information requirements and the units' SOP should guide the type and number of charts the unit needs. The display must answer most of the CCIR, using multiple means to display PIR, EEFI, FFIR, and decision points.

The future information display and the current information display use the same format. Their main difference is that the current operations chart reflects the current situation; the future operations chart reflects assumptions based on current facts. The staff must constantly reevaluate these assumptions on emerging facts. The commander must assess the validity of all assumptions to determine their impact on the planned operation and any modifications the plan might need.

Impact on Decision Making

Information is the key to effective synchronization. Synchronization requires early decisions that enable the staff to arrange battlefield activities in time, space, and purpose to produce maximum relative combat power at the decisive point. The time-distance and density factors that are associated with modern warfare require commanders to—

- Make critical decisions using information based more on assumptions than facts.

- Decentralize execution, providing subordinate commanders with task organizations capable of semi-independent execution.
- Specify and streamline the information flow throughout the C² system.
- Comply with the commanders' intentions, seeing their own plan through to success.

Commanders must be resolute in accepting risk and be willing to make decisions based only on the information

immediately available. Each commander, therefore, becomes the catalyst for effecting changes within the C² system that his demands for information place on the command.

Risk is expected. The speed, type, and quality of information the C² system places in front of the decision maker can effectively minimize risk while optimizing the unit's capacity to remain responsive and agile.

Appendix J

RISK MANAGEMENT

Risk management is integrated into the military decision-making process. (See Chapter 5.) When assessing the risk of hazards in operations, the commander and staff must look at two kinds of risk, tactical risk and accident risk.

Tactical risk is risk associated with hazards that exist due to the presence of the enemy on the battlefield. The consequences of tactical risk take two forms. The first is if the enemy takes action in an area where the commander has accepted risk, for example, an enemy attack where the friendly commander is conducting economy of force operations in order to mass the effects of combat power elsewhere. The second is one of lost opportunity, for example the commander takes risk in moving forces across restricted terrain to gain the advantage of surprise, but is unable to mass the effects of combat power because the unit is unable to rapidly traverse the terrain. The commander alone determines how and where he is willing to take tactical risk.

Accident risk includes all operational risk considerations other than tactical risk, and can include activities associated with hazards concerning friendly personnel, equipment readiness, and environmental conditions. Accident hazards exist regardless of enemy action, even in the absence of an enemy force. Examples of accident hazards include personnel that are not adequately trained to conduct certain kinds of operations, equipment that is not fully operational, and environmental conditions that make operations more dangerous, such

as limited visibility and extreme cold weather. Accident risk is managed by both the commander and the staff. Staff members are constantly looking for accident hazards associated with their areas of expertise, and they recommend controls to reduce risk.

Tactical risk and accident risk may be diametrically opposed. The commander may accept a high level of accident risk in order to reduce tactical risk. For example, during the seizure of the Remagen Bridge, the benefit of seizing an intact bridge over the Rhine outweighed the extremely high risk of sending soldiers across a bridge rigged for demolitions. Both types of risks are managed by the commander with assistance from his staff. Risk decisions are the sole provenance of the commander.

The same risk-management process is used to assess and evaluate both tactical and accident risks. Risk management must become a pattern of thinking—identify and assess the hazard, develop controls to reduce the risk, decide if the benefit from the operation justifies the risk, and then implement controls and supervise.

Figure J-1 is a matrix of risk management steps as they relate to each step of the MDMP.

DEFINITIONS

Hazard is any actual or potential condition that can cause injury, illness, or death of personnel; damage to or loss of equipment or property; or mission degradation.

	IDENTIFY HAZARDS	ASSESS HAZARDS	DEVELOP CONTROLS & MAKE RISK DECISION	IMPLEMENT CONTROLS	SUPERVISE & EVALUATE
RECEIPT OF MISSION	X				
MISSION ANALYSIS	X	X			
COA DEVELOPMENT	X	X	X		
COA ANALYSIS	X	X	X		
COA COMPARISON			X		
COA APPROVAL			X		
ORDERS PRODUCTION				X	
PREPARATION				X	X
EXECUTION				X	X

Figure J-1. Risk management actions integrated into the military decision-making tasks

Condition is the readiness status of personnel and equipment with respect to the operational environment during mission planning, preparation, and execution. Readiness that is below standards leads to human error, material failure, and inadequate precautions for environmental factors, which may cause accidents, fratricide, and mission degradation.

Risk is the probability of exposure to injury or loss from a hazard. Risk level is expressed in terms of hazard probability and severity.

Exposure is the frequency and length of time personnel and equipment are subjected to a hazard.

Severity is the degree of injury, property damage, or other mission-impairing factors (loss of combat power, adverse publicity) that could occur as a result of a hazard.

Controls are actions taken to eliminate hazards or reduce their risk.

Risk assessment is the identification and assessment of hazards (the first two steps of the risk management process).

Residual risk is the level of risk remaining after controls have been selected for hazards. (Controls are identified and selected until residual risk is at an acceptable level or until it cannot be practically reduced further.)

RISK MANAGEMENT STEPS

Risk management is identifying and controlling hazards to protect the force and increase the chance of

mission accomplishment. It is conducted by the commander and the staff and is applicable to any mission and environment. The five steps of risk management are:

Step 1. **Identify hazards.** Identify hazards to the force. Consider all aspects of METT-T for current and future situations. Sources of information about hazards include reconnaissance, experience of commander and staff, safety SOP, and the unit's accident history. Hazards that cannot be adequately controlled by the unit or its subordinate units, and which are most likely to result in loss of combat power, should be risk-managed. To determine this, answer the questions in Figure J-2.

Step 2. **Assess hazards.** Assess each hazard to determine the risk of potential loss based on probability and severity of the hazard. Determining the risk from a hazard is more an art than a science. Use historical data, intuitive analysis, judgment, and the matrix at Figure J-3 to estimate the risk of each hazard. The risk assessment matrix is entered from the probability column and the severity row. Probability and severity levels are estimated based on the user's knowledge of probability of occurrence and the severity of consequences once the occurrence happens. The intersection of the probability column and the severity row defines the level of risk.

Step 3. **Develop controls, determine residual risk, and make risk decision.**

a. Develop controls. For each hazard, develop one or more controls that will eliminate or reduce the risk of the hazard. Specify who, what, where, when, and how for each control. When developing controls consider the reason for the hazard, not just the METT-T

Q - Is hazard adequately controlled?		Adequate	
		YES	NO
Identified METT-T hazard	Support - Is support available (personnel, equipment, supplies, facilities) adequate to control the hazard?		
	Standards - Is guidance or procedure adequately clear, practical, and specific to control hazard?		
	Training - Is training adequate to control the hazard?		
	Leader - Are leaders ready, willing, and able to enforce standards required to control hazard?		
	Individual - Is soldier performance sufficiently self-disciplined to control hazard?		

A - If all "yes," no further action.
 - If one or more "no," risk-manage this hazard.

Figure J-2. Determining which hazards to risk-manage

		HAZARD PROBABILITY				
		Frequent	Likely	Occasional	Seldom	Unlikely
S E V E R I T Y	Catastrophic	E	E	H	H	M
	Critical	E	H	H	M	L
	Marginal	H	M	M	L	L
	Negligible	M	L	L	L	L

HAZARD PROBABILITY (The likelihood that an event will occur)

- Frequent** - Occurs often, continuously experienced.
- Likely** - Occurs several times.
- Occasional** - Occurs sporadically.
- Seldom** - Unlikely, but could occur at some time.
- Unlikely** - Can assume it will not occur.

SEVERITY (The degree of injury, property damage, or other mission-impairing factors.)

- Catastrophic** - Death or permanent total disability, system loss, major property damage.
- Critical** - Permanent partial disability, temporary total disability in excess of three months, major system damage, significant property damage.
- Marginal** - Minor injury, lost workday accident, minor system damage, minor property damage.
- Negligible** - First aid or minor medical treatment, minor system impairment.

RISK LEVELS

- E (Extremely High)** - Loss of ability to accomplish mission.
- H (High)** - Significantly degrades mission capabilities in terms of required mission standard.
- M (Moderate)** - Degrades mission capabilities in terms of required mission standards.
- L (Low)** - Little or no impact on accomplishment of mission.

Figure J-3. Individual hazard risk assessment matrix

factor itself (Figure J-2). Effective control can be implemented through individual and collective training that ensures performance to standard. The CofS (XO) coordinates development of controls with emphasis on de-conflicting controls that affect multiple functional areas and adjacent units.

b. Determine residual risk. For each hazard, as controls are developed, revise the evaluation of the level of risk remaining (residual risk), assuming the controls for it are implemented.

c. Make risk decision. The commander alone decides whether or not to accept the level of residual risk. If the commander determines the risk is too great to continue the mission or a COA, he directs the development of additional controls, or he modifies, changes, or rejects the COA or mission.

Step 4. **Implement controls.** State how each control will be put into effect and communicated to personnel who will make it happen.

Step 5. **Supervise and evaluate.**

a. Supervise controls. Explain how each control will be monitored to ensure proper implementation.

b. Evaluate controls. Evaluate the effectiveness of each control in reducing or eliminating risk. For controls that are not effective, determine why and what to do the next time the hazard is identified. For example, in the next operation the commander and staff might change the control, develop a different control, or change how the control will be implemented or supervised. The commander and staff must fix systemic problems (Figure J-2) hindering combat effectiveness and capture and disseminate lessons learned.

Appendix K

COMMANDER AND STAFF TRAINING

Developing an effective and efficient commander and staff team requires team training that focuses on critical tasks. Unit-training opportunities at the combat training centers such as the battle command training program (BCTP) or joint readiness training center (JRTC) are too infrequent to sustain a unit's commander and staff proficiency. Therefore, it is the commander's responsibility to train his staff and subordinate commanders to work as a cohesive team. The commander must continually determine his staff's training needs, plan and execute a training program, and assess the results. This appendix discusses training on the military decision-making process (MDMP).

FUNDAMENTALS

The commander and his staff must be a cohesive team. The staff must firmly understand Army doctrine and anticipate the commander in order to produce comprehensive and synchronized plans consistent with the commander's guidance. The challenges of battle command require meticulous commander and staff training in decision making (both the full MDMP and the abbreviated process), estimate procedures, information management, orders preparation, and rehearsals. The relationship between unit missions and the mission-essential task list (METL) affects staff training just as it affects a unit's individual and collective training. The commander develops the staff METL for training in accordance with FM 25-100 and FM 25-101. Planning associated with the existing unit METL provides excellent opportunities to exercise staff training and interaction.

Rapid changes in staff composition require a training program that will—

- Quickly orient newly assigned staff members.
- Rapidly assess the staff's technical and tactical proficiency.
- Provide battle-focused individual and collective staff training.
- Provide sustainment of soldier, leader, and team skills.
- Develop skills in both the full MDMP and time-constrained variants.

The commander structures staff training on the MDMP by presenting the staff with situations in which the staff must conduct a complete MDMP or an abbreviated MDMP. The commander coaches and directs questions to the staff members, asking them to explain or clarify their rationale. The commander then assesses the accuracy and depth of their thought processes and their products. He then provides feedback to the staff, assessing how well staff members have provided the information and support the commander's desires.

The commander can use this procedure for staff training in individual and collective battle tasks, basing training on hypothetical situations or on actual war plans. This training helps the commander and staff to—

- Sharpen thinking.
- Assess what additional training the staff needs.
- Increase understanding of how the commander thinks and operates.
- Improve cohesion and enhance morale, trust, and confidence.
- Determine how best to modify the MDMP in a time-constrained environment and increase understanding of each member's role in the abbreviated process.

This training procedure helps the staff officer to—

- Sharpen his thinking.
- Increase his understanding of how his commander operates.
- Improve his ability to anticipate requirements.
- Improve cohesion between the commander and the staff.
- Understand his role in the full MDMP and the abbreviated process.

Staff skills are predominately trained during multi-echelon training activities. The commander must ensure multi-echelon exercises provide the staff useful training. The commander and CofS (XO) must not assume that training will inherently occur in the course of planning and executing nonbattle-focused activities. The commander should free the staff from administrative tasks that hamper their training.

Planning Process	Cdr	Staff Officers	Staff NCOs	RTOs	Clerks/Typists
Mission Analysis: - Prepare charts for mission analysis - Prepare terrain sketches - Update and post unit reports/status - Prepare TOC for planning process - Conduct mission analysis - Serve as a recorder during process - Brief commander and staff	X	X	X X X X	X X X X	X X X X
Commander's Guidance: - Assist commander in developing guidance - Issue guidance - Record/post commander's guidance	X	X X	X X	X	X
COA Development: - Prepare charts - Sketch COAs - Develop COAs	X	X	X	X X	X X
COA Analysis: - Collect and prepare tools/charts - Serve as recorders during war game - Conduct war-game session	X	X	X X	X X	X X
Decision: - Make recommendation to commander - Decide - Record/post commander's guidance	X	X X	X X	X	X
Orders Preparation: - Write annexes - Consolidate annexes - Type order - Reproduce order/graphics - Review order - Approve order	X X	X X	X X X X	X X X	X X

Figure K-1. Command and staff duties in the MDMP

If the staff is relatively inexperienced in the decision-making process, training should begin with classes on the MDMP. These classes should focus on ensuring that all personnel who participate in the planning process understand the formal process. This training should include slice units that will be expected to participate in the process. This training will allow the commander to eventually customize and streamline the

planning process for the unit. During this training, the staff should identify specific roles and responsibilities of each individual involved. The frequency of this training will depend on personnel turbulence. Figure K-1 identifies command and staff duties in the MDMP.

After the initial training, the commander should exercise the staff using the MDMP. The staff must first be able to conduct the MDMP to standard before it can

attempt to abbreviate the process. A good technique to conduct this training is the small group instruction (SGI) method, similar to that used in the advanced courses, with the commander serving as the SGI. *This task should not be left to the CofS (XO).* This is the commander's opportunity to prepare and train his staff.

Training must incorporate staff NCOs and enlisted soldiers. If trained properly, they can be an asset to the process, and save the staff officers significant time. Figure K-1 shows where to incorporate NCOs and enlisted soldiers in the process.

TECHNIQUES

The commander should request support from sister service units to provide observer and controller (OC) coverage during the exercise. The OCs conduct after-action reviews (AARs) to provide feedback throughout the planning process.

Command posts should be set up to replicate a field environment. Conducting the exercise in a garrison or an office environment is much different from conducting the exercise in a field setting. This also provides the opportunity to exercise command posts and adjust to their organization or layout based on the commander's desires and the staff's lessons learned.

The commander and staff incorporate in the planning process the production of plans and orders for as many day-to-day activities as possible. This should include developing orders for range operations; change of command ceremonies; gunnery; and squad, platoon, and company lanes, as well as orders to initiate all field training and command post exercises.

While conducting planning exercises, the commander and staff should identify what planning charts and tools they want to incorporate into their SOP. The unit should develop and refine its planning SOP during this training.

When the unit prepares quarterly training guidance, it should prepare, issue, and include an operation order or operation plan. This order can then serve as a common scenario for subordinate units to use to exercise their decision-making process. They can use the same order to practice the MDMP and to work on abbreviating the process under time constraints. This technique not only provides subordinates a training opportunity, but also allows the staff to exercise the process and conduct all vertical and horizontal coordination as necessary. The training should include confirmation briefs, backbriefs, and rehearsals as well.

Many delays in the planning process are related to the IPB. Often this is because the G2 (S2) staff is conducting the majority of the IPB process itself. Commanders should dedicate time to train and refine skills for all subordinates in the G2 (S2) section. Training should focus on—

- Reviewing enemy doctrine, tactics, techniques, and procedures.
- Reviewing terrain analysis techniques and procedures.
- Developing doctrinal, situational, and event templates.
- Developing event and TAI templates.

Appendix L

LIAISON

Liaison is the contact or intercommunication maintained between elements of military forces to ensure mutual understanding and unity of purpose and action. Liaison helps reduce the fog of war through direct communications. It is the most commonly employed technique for establishing and maintaining close, continuous physical communication between commands.

Liaison is used during operations and normal daily activity between units to help facilitate communication, preserve freedom of action, and maintain flexibility. Liaison ensures that senior commanders remain aware of the tactical situation by providing them with exceptional, critical, or routine information; verification of information; and clarification of operational questions.

Liaison activities augment the commander's ability to synchronize and focus the combat power. Liaison activities include establishing and maintaining physical contact and communication between elements of military forces and, as directed, nonmilitary agencies. Liaison activities ensure—

- Mutual cooperation and understanding between commanders and staffs of different headquarters.
- Coordination on tactical matters to achieve mutual purpose, support, and action.
- Exact and precise understanding of implied or inferred coordination measures to achieve synchronized results.

Overall, liaison becomes another tool to help commanders overcome friction, gain assurance that subordinate commanders understand implicit coordination, and achieve synchronized results. Effective liaison enhances the commander's confidence in planning and in mission execution.

LIAISON ELEMENTS

Joint and multinational operations require augmentation by individual mobilization augmentees (IMAs) or individual ready reserve (IRR) personnel to fill necessary liaison positions. Liaison elements include—

- The liaison officer (LNO), who represents the commander or a special functional area.

Liaison Qualifications	
	Recommended (1 officer)
Corps	Major
Division	Captain
Brigade, regiment, or group	Captain
Battalion	First Lieutenant

Figure L-1. Rank composition of senior liaison team personnel from the sending (dispatching) unit to the receiving unit

- Liaison detachments, composed of several teams with expertise in specialized areas, such as intelligence, operations, fire support, airspace command and control (AC²), engineering, CSS, and so forth; each team normally remains at the receiving headquarters until recalled to the sending unit.
- Liaison teams, composed of liaison officers, a liaison noncommissioned officer in charge (NCOIC), clerical personnel and drivers, and communications personnel with their equipment.
- Couriers (messengers) responsible for the secure physical transmission and delivery of documents and material.

See Figure L-1.

THE LIAISON OFFICER

The commander uses a liaison officer to transmit critical information while bypassing layers of staffs and headquarters. A trained, competent, trusted, and informed liaison officer (either an officer or a noncommissioned officer) is the key to effective liaison. The liaison officer must have the proper rank and experience for the mission and have the commander's full confidence. When interfacing with joint and multinational forces, rank may need to be increased to enhance accessibility and influence. Employing one individual conserves manpower while guaranteeing the consistent, accurate

flow of information. However, continuous operations require a liaison team.

The liaison officer normally is a special staff officer. He is the personal representative of the commander and has access to his commander consistent with his duties. However, for routine matters, he works for and receives direction from the CofS (XO).

The liaison officer's parent unit is the sending unit; the unit the liaison officer visits or is attached to is the receiving unit. A liaison officer normally remains at the receiving headquarters until recalled to the sending unit. Because the liaison officer represents his commander, he must be able to—

- Understand how his commander thinks.
- Interpret his commander's messages.
- Convey his commander's vision, mission, and concept of operations and guidance.
- Represent his commander's position.

The liaison officer's professional capabilities and personal characteristics must encourage confidence and cooperation with the commander and staff of the receiving unit. He must—

- Be thoroughly knowledgeable of the sending unit's mission and its tactics, techniques, and procedures (TTP); organization; capabilities; and communications equipment.
- Be familiar with the doctrine and staff procedures of the receiving unit's headquarters.
- Appreciate and understand the receiving unit's procedures, organization, capabilities, mission, and customs. (In the case of multinational forces, understanding the unit's doctrine is critical.)
- Be familiar with the requirements for and the purpose of liaison; the liaison system, and its corresponding reports, reporting documents, and records; and the training of the liaison team.
- Observe the established channels of command and staff functions.
- Be of sufficient rank to effectively represent his commander with the receiving unit's commander and staff.
- Be trained in his functional area.
- Possess tact.

- Possess the necessary language expertise, if required.

LIAISON PRINCIPLES

A principle is a description of the inherent or natural laws governing how something works. When possible, liaison should be reciprocal between higher, lower, and adjacent formations. It *must* be reciprocal when US forces are placed under the command and control of a headquarters of a different nationality and vice versa, or when brigade-sized and larger formations of different nationalities are adjacent.

When liaison is *not* reciprocal, the following principles apply:

- Higher-echelon units establish liaison with lower echelons.
- Units on the left establish liaison with units on their right.
- Supporting units establish liaison with units they support.
- Units of the same echelon and units in the rear establish liaison with those to their front.
- Units not in contact with the enemy establish liaison with units that are in contact with the enemy.
- When conducting a passage of lines, the moving unit establishes liaison with the stationary unit. (This applies to both forward and rearward passages of lines.)
- The incoming force establishes liaison with the outgoing force during a relief of combat troops.

If liaison is broken, both parties must attempt to reestablish it. However, the primary responsibility rests with the headquarters originally responsible for establishing liaison.

LIAISON RESPONSIBILITIES

The Sending Unit

The sending unit's most important tasks include selecting and training the right persons as liaison officers. The sending unit must ensure the liaison officer meets all liaison characteristics and requirements and—

- Is tactically and technically competent, skilled, and mature.

- Is familiar with the receiving headquarters' doctrine and staff procedures.
- Understands the sending headquarters' current and future operations and his commander's mission, intent, concept of operations, and critical activities.
- Understands what information his commander wants the receiving commander to know.

The sending unit must provide a description of the liaison party (number and type of vehicles, personnel, call signs, radio frequencies, and so on) to the receiving unit. The liaison officer or team must also—

- Have identification and appropriate credentials for the receiving unit.
- Have appropriate security clearance, courier orders, transportation, and communications equipment.
- Have an SOP outlining the missions, functions, procedures, and duties of the sending unit's liaison section.
- Have weapons and ammunition for personal protection.
- Have rations for the transit from the sending unit to the receiving unit.

The Receiving Unit

The receiving unit is responsible for—

- Providing the sending unit with the liaison officer's reporting time, place, point of contact, recognition signal, and password.
- Providing details of any tactical movement and logistics information relevant to the liaison officer's mission, especially while he is in transit.
- Ensuring that the liaison officer has access to the commander, the CofS (XO), and other officers for important matters.
- Giving the liaison officer an initial briefing and allowing him appropriate access so that he may remain informed of current operations.
- Providing protection for the liaison officer while he is at the receiving unit.
- Publishing an SOP outlining the missions, functions, procedures, and duties of the liaison officer or team at the receiving unit.

- Providing access to communications equipment (and operating instructions, as needed) when the liaison officer is to communicate on the receiving unit's equipment.
- Providing administrative and logistics support.

Liaison Duties During the Tour

Liaison officers also provide the receiving unit's commander or staff with knowledge of the sending unit's needs or requirements. The liaison officer's ability to rapidly clarify questions about the sending unit can keep the receiving unit from wasting time (thus decreasing frustration) while planning a course of action that best supports the senior commander's intentions.

During the liaison tour, the liaison officer or team—

- Arrives at the designated location at the designated time.
- Promotes cooperation between the sending headquarters and the receiving headquarters.
- Accomplishes its mission without becoming actively involved with the receiving unit's staff procedures or actions; however, it may assist higher staffs in war gaming when requested to do so.
- Uses communications in accordance with the receiving unit's procedures.
- Accomplishes its mission without interfering with the receiving headquarters' operations. The liaison team must be proactive in obtaining information.
- Facilitates comprehension of the sending unit's commander's intent.
- Helps the sending unit's commander assess current and future operations.
- Remains informed of the sending unit's current situation and makes that information available to the receiving unit's commander and staff.
- Expeditiously informs the sending unit of upcoming missions, tasks, and orders of the receiving unit.
- Reports to the sending unit on matters within the scope of its mission.
- Ensures that a copy of the receiving unit's SOP is available at the sending unit.
- Informs the receiving unit's commander or CofS (XO) of the content of the reports it transmits to the sending unit.

- Keeps a record of its reports, listing everyone met (including the person's name, rank, duty position, and phone number) as well as primary operators and their phone numbers.
- Attempts to resolve issues proactively within the receiving headquarters before involving the sending unit.
- Notifies the sending unit promptly if unable to accomplish the liaison mission.
- Reports its departure to the receiving unit's commander after completing the mission.
- Reports future operations to the sending unit so that the sending unit can begin preliminary planning for anticipated future events or activities.

Liaison Duties After the Tour

After returning to the sending unit, the liaison team promptly transmits the receiving unit's requests to the sending unit's commander or staff, as appropriate. The team also briefs the CofS (XO) on mission-related liaison activities and prepares a written report, as appropriate.

Accuracy is paramount. The team must provide clear, concise, complete information. If accuracy is not certain, it should quote the source. The liaison team should limit its remarks to observations that are mission-related.

NOTE: For convenience, a liaison-team checklist and an example outline of a liaison officer's handbook are located at the end of this appendix.

LIAISON IN SPECIFIC OPERATIONS

Liaison is a routine assignment having specific responsibilities for specific operations, including deployment, joint, multinational, and interagency operations.

Deployment Operations

The unfamiliarity of the area of operations requires extensive research for staff estimates. Some operations require tight security that restricts access or dissemination and affects the time line. During certain operations, completely new C² relationships are established resulting in slower staff coordination and action due to unfamiliarity with SOPs and even unit equipment and personnel. When a tailored task organization, based on a

specific operation, is added to the new C² relationships, the staff is again pushed to make the reduced time line. The staff must expend additional time working through routine and nonroutine activities. The staff will generate more requests for information and this increases time requirements. An example of this is requesting maps for the area of operations.

Unfamiliarity with the units in his command and the area of operations can cause confusion for the commander. Such confusion, in turn, could cause conflicting guidance, frequent planning changes, and inefficient execution of deployment tasks. The commander must anticipate conflicting conditions and have a system in place to cut through the confusion. This increases the need for nonroutine information. In such a situation, liaison is the key. During deployment, the liaison officer becomes a conduit for information. By providing accurate information, he can help the commander establish order, efficiency, and expediency.

The liaison officer must always be mindful of his commander's need for information to complete planning and coordination. Information needs might include—

- The type of transportation the unit needs for deployment and resupply.
- The communications systems and intelligence products available.
- Opening of channels of communications that will become routine later.
- The level and extent of protection the unit needs as it arrives, disembarks, and prepares for combat operations.
- The unit's staging area requirements.
- The unit's combat capability and sustainment requirements.
- The CSS commodities, services, and facilities the Army component of a joint force must provide to other service components in the area of operations.
- Local tactical intelligence products otherwise unavailable to the commander.
- Unit movement officer responsibilities.

Joint Operations

During joint operations, interoperable communications systems among services are rare. Therefore, Army

liaison teams must have communications systems that can rapidly exchange information between commands.

Current joint operations communications systems do not provide for all operational requirements. Therefore, the Army must use liaison to ensure that the actions of Army forces and forces of other services are coordinated and synchronized, and that they support the joint force commander's plan.

In the joint force, the senior Army headquarters provides liaison to the equivalent headquarters of the other services. The senior Army headquarters should also establish liaison with the headquarters of the joint force commander. Subordinate Army organizations and units with similar-size adjacent service commands might also exchange liaison officers.

Liaison officers must have a working knowledge of the supported unit's doctrine and TTPs so that they can rapidly translate information into information products Army personnel can understand. This is particularly critical when units have no habitual relationship or have not recently trained together, such as when naval air provides air support to Army maneuver units.

Multinational Operations

Mutual confidence is the key to making multinational operations successful. Liaison activities require explicit coordination of doctrine and techniques, greater patience and tact during personal interaction, and thorough understanding of the strategic, operational, and tactical aims supporting the international effort.

When operating as a multinational force, US Army units must cooperate with military forces and civilian agencies of other nations. Cultural differences and sensitivities require special communications and liaison arrangements to ensure explicit understanding throughout the alliance or coalition.

Significant differences may also occur because of each force's differing degree of technological sophistication. Doctrine and procedures may have been established (for example, standardization agreements), developed, and practiced to maximize coordination. In other cases, there may be no previous agreements. Also, US and other participating forces must often determine procedures for multinational operations while under the pressure of imminent conflict or even after combat has begun.

In multinational operations, factors to consider include the following:

- Special communications and liaison arrangements are required to ensure explicit understanding throughout the multinational operation.

- Ideally, a liaison officer should speak the language of the force to which he is attached. If not, he must be accompanied by interpreters who have the same access to classified information as the liaison officer they support.

- Tact and an understanding of other nations' characteristics and culture are essential. Other nations often resent any semblance of a dictatorial manner in liaison officers or visiting staff officers.

- The liaison officer must clearly impart to a foreign unit commander that the orders come directly from the more senior commander—not from a staff officer empowered to speak in the senior commander's name.

- When a liaison officer must send a message from the receiving commander's unit to the sending unit, he should first show the English version of the message to the foreign force commander or his senior staff officer to ensure the message correctly reflects the meaning and emphasis of the original message.

- Specialist liaison officers (such as aviation, fire support, engineer, intelligence, military police, transportation, and civil affairs officers) may be exchanged when foreign or US forces must interact with units, equipment, or procedures with which they are unfamiliar.

NOTE: See also FM 100-8.

Interagency Operations

Liaison teams may also represent their commanders when the command is conducting operations in an interagency environment. This is true in war and when conducting stability and support operations. Frequently, the Army conducts peacetime operations under the leadership and control of civilian government agencies. For example, the Federal Emergency Management Agency (FEMA) has overall charge of federal government disaster relief within the United States and its territories and possessions.

In other peacetime operations, government agencies such as the US Forest Service, the Drug Enforcement Agency (DEA), or the FBI may be the lead agency, depending on the problem. The US Army may find itself in a supporting role. However, unlike operations Army forces normally conduct, interagency operations may

lack unity of command. All government agencies may be working toward a common goal but not under a single authority.

There may also be compelling reasons to coordinate with nongovernment organizations and private voluntary organizations (PVOs). No overarching interagency doctrine delineates or dictates the relationships and

procedures governing all agencies, departments, and organizations in interagency operations. Liaison elements must work toward establishing mutual trust and confidence, continuously coordinating actions to achieve cooperation and unity of effort.

NOTE: See also JP 3-08.

LIAISON CHECKLIST

Before Departing the Sending Unit

- _____ 1. Do you understand what the commander wants the receiving commander to know?
- _____ 2. Did you arrange for a briefing from operations, intelligence, and other staff elements concerning current and future operations?
- _____ 3. Did you verify the receipt of and do you understand the tasks your staff has given you?
- _____ 4. Did you obtain the correct maps, traces, overlays?
- _____ 5. Did you arrange for transport, communications and cryptographic equipment, codes, and signal instructions, and for their protection and security?
- _____ 6. Did you arrange for replacement of these items, as necessary?
- _____ 7. Did you arrange for the departure of the liaison party?
- _____ 8. Did you complete route-reconnaissance and time-management plans so that you will arrive at the designated location on time?
- _____ 9. Did you ensure that liaison personnel and interpreters have security clearances and access appropriate for the mission?
- _____ 10. Did you verify that the receiving unit received the liaison team's security clearances and that the receiving unit will grant access to the appropriate level of information the mission requires?
- _____ 11. Did you verify courier orders?
- _____ 12. Do you know how you are to destroy the information you are carrying in an emergency, in transit, and at the receiving unit?
- _____ 13. Do you have signal operating instruction (SOI)? (Do you know the challenge and password?)
- _____ 14. Did you inform your headquarters of when you will leave, what route you will take, when you are to arrive and, when known, the estimated time and route of your return?
- _____ 15. Did you pick up all correspondence designated for the receiving headquarters?
- _____ 16. Did you conduct a radio check? (Have current and next fill?)
- _____ 17. Do you know the impending moves of your headquarters and of the receiving headquarters?
- _____ 18. Did you bring automation or computers to support your operation?
- _____ 19. Did you pack adequate supplies of Class I and III for use in transit?

During the Liaison Tour

- _____ 20. Did you arrive at least two hours before any scheduled briefings?

- _____ 21. Did you check in with security and complete any required documentation?
- _____ 22. Did you present your credentials to the CofS (XO)?
- _____ 23. Did you arrange and receive an “office call” with the commander?
- _____ 24. Did you meet the coordinating and special staff officers?
- _____ 25. Did you notify your own headquarters of your arrival?
- _____ 26. Did you deliver all correspondence designated for the receiving headquarters?
- _____ 27. Did you visit staff elements, brief them on the situation of your unit, and collect information from them?
- _____ 28. Did you annotate on all overlays the security classification, title, map scale, grid intersection points, date-time group (DTG) information, DTG received, and from whom received?
- _____ 29. Did you pick up all correspondence for your headquarters when you left the receiving unit?
- _____ 30. Did you inform the receiving headquarters of when you would depart, what route you would take, and when you expect to arrive at the sending unit?

After Returning to the Sending Unit

- _____ 31. Did you deliver all correspondence?
- _____ 32. Did you brief the CofS (XO) and the appropriate staff elements?
- _____ 33. Did you prepare the necessary reports?
- _____ 34. Did you clearly state what you learned from the mission?
- _____ 35. Did you clearly state what you did NOT learn from the mission?

EXAMPLE OUTLINE OF A LIAISON OFFICER’S HANDBOOK

1. Table of contents, with the sending unit’s proponenty statement.
2. Purpose statement.
3. Introduction statement.
4. Definitions.
5. Scope statement.
6. Responsibilities and guidelines for conduct.
7. Actions before departing from the sending unit.
8. Actions on arriving at the receiving unit.
9. Actions during liaison operations at the receiving unit.
10. Actions before departing from the receiving unit.
11. Actions on arrival at the sending unit.
12. Sample questions. The following is a list of common questions that the receiving commander may ask a liaison officer or that the liaison officer should consider to help represent his commander.
 - a. Does the sending unit have a copy of the receiving unit’s latest OPLAN, OPORD, FRAGO, and so on?

FM 101-5

b. Do the receiving unit's plans support the higher headquarters' plan? This includes logistics as well as the tactical concept. Are main supply routes and required supply rates known? Can the controlled supply rate's feasibility support the receiving unit's plan?

c. What are the commander's critical information requirements? At what time, phase, or event do you expect them to change? Are there any items the CCIR do not contain which the sending unit can help you with?

d. What sending commander decisions are critical to the receiving commander's execution of his plan? What are the no later than times for those decisions?

e. What assets does the unit need to accomplish its mission that it does not have now? How would they be used? How do they support attaining the more senior commander's intent? Where can the unit get them? Higher headquarters? Other services? Allies?

f. How are aviation assets (rotary and fixed wing) being used?

g. Do you know all the ways you can talk to the sending unit? Are there telephones, radios, facsimile machines, computers, and so on? Where are they located? Which ones are secure?

h. What terrain has been designated as decisive? Key?

i. What weather conditions would have a major impact on the operation?

j. What effect would a chemical environment have on the operation?

k. What effect would large numbers of refugees or EPWs have on the receiving unit's operations?

l. What is the worse thing that could happen during execution of the current operation (plan)?

m. How would you handle a passage of lines by other units through your own force?

n. What conditions would cause your unit to request OPCON of a coalition or multinational force?

o. If your unit were placed under OPCON of a larger coalition or multinational force or given OPCON of a smaller such force, what special problems would it present?

p. If going to a coalition or multinational force headquarters, how do their tactical principles and command concepts differ?

q. What host nation support is available to the sending unit?

13. Information requirements.

14. Required reports (from higher and sending units' SOP).

15. Packing list (administrative supplies and unit SOP, field uniform, equipment).

a. Credentials (including permissive jump orders, if qualified).

b. Forms.

(1) DA Forms 1594 (Daily Staff Journal or Duty Officer's Log).

(2) Other blank forms.

c. References.

d. Computers for information and data exchange.

e. Signal operating instructions extract.

f. Security code encryption device.

g. Communications equipment, including remote frequency modulation (FM) equipment.

- h. Phone book.
 - i. List of commanders and staff officers.
 - j. Telephone calling (credit) card.
 - k. Movement table.
 - l. Administrative equipment (pens, paper, scissors, tape, hole punch, and so on).
 - m. Map and chart equipment (pens, pins, protractor, straight edge, scale, distance counter, acetate, unit markers, and so on).
 - n. Tent (camouflage net, cots, stove, and so on, as appropriate).
 - o. Foreign phrase book and dictionary.
 - p. Local currency as required.
16. References.
17. Excerpts of higher and sending headquarters' orders and plans.
18. Sending unit's command diagrams and recapitulation of major systems. The unit MTOE, unit status report (if appropriate because of the classification of the report), and mission briefings can be used. The G3 (S3) operations officer or the force modernization office is an excellent source for information.

GLOSSARY

AA	avenue of approach	CHEMO	chemical officer
AC²	airspace command and control	CHS	combat health support
ABCS	Army Battle Command System	CI	counterintelligence
ACO	airspace control order	CINC	commander in chief
acq	acquisition	cl	class
ACR	armored cavalry regiment	CM	countermobility
ACofS	assistant chief of staff	cml	chemical
AD	air defense	CMO	civil-military operations
ADA	air defense artillery	CMOC	civil-military operations center
ADC	assistant division commander	cmt	comment
ADCOORD	air defense coordinator	co	company
AF	Air Force	COA	course of action
AG	adjutant general	COLT	combat operation laser team
AH	attack helicopter	COMMZ	communications zone
AI	air interdiction	COMSEC	communications security
ALO	air liaison officer	CONPLAN	concept plan
ANGLICO	air/naval gunfire liaison company	CONUS	continental United States
anx	annex	coord	coordinate
AO	area of operations	COSCOM	corps support command
app	appendix	CP	command post
AR	Army regulation	CPO	civilian personnel office/officer
armd	armored	CofS	chief of staff
arty	artillery	CS	combat support
atk	attack	CSM	command sergeant major
ATO	air tasking order	CSR	controlled supply rate
ATP	ammunition transfer points	CSS	combat service support
AVCOORD	aviation coordinator		
avn	aviation	DA	Department of the Army
AWOL	absent without leave	DEH	Director of Engineering and Housing
AXP	ambulance exchange point	DISCOM	division support command
		div	division
bde	brigade	DIVARTY	division artillery
bn	battalion	DOD	Department of Defense
BSA	brigade support area	DOL	Director of Logistics
btry	battery	DP	decision point
		DPTM	Director of Plans, Training, and Mobilization
C²	command and control	DRM	Director of Resource Management
C²W	command and control warfare	DS	direct support
CA	civil affairs	DST	decision support template
CAS	close air support	DTG	date-time group
cav	cavalry		
cbt	combat	EA	engagement area
CCIR	commander's critical information requirements	EAC	echelons above corps
cdr	commander	EC	electronic combat
CFC	combined forces command	EEFI	essential elements of friendly information
CG	commanding general		
ch	chaplain	eny	enemy

FM 101-5

ENCOORD	engineer coordinator	IEW	intelligence and electronic warfare
engr	engineer	IG	inspector general
EO	equal opportunity	inf	infantry
EOA	equal opportunity advisor	intel	intelligence
EOD	explosive ordnance disposal	IPB	intelligence preparation of the battlefield
EPW	enemy prisoner of war	IR	infrared
EW	electronic warfare		
FA	field artillery	JP	joint publication
FAC	forward air controller	JSEAD	joint suppression of enemy air defense
FASCAM	family of scatterable mines		
FEBA	forward edge of the battle area	LC	line of contact
FFIR	friendly forces information requirements	LD	line of departure
FLOT	forward line of own troops	LLTR	low-level transit route
FM	field manual; frequency modulation	LNO	liaison officer
FO	field order		
FRAGO	fragmentary order	MDMP	military decision-making process
FS	fire support	mech	mechanized
FSB	forward support battalion	MEDEVAC	medical evacuation
FSCoord	fire support coordinator	METL	mission-essential task list
FSO	fire support officer	METT-T	mission, enemy, terrain, troops, and time available
G1	personnel, general staff	MFR	memorandum for record
G2	intelligence, general staff	MG	major general
G3	operations (division); operations and plans (corps), general staff	MGRS	military grid reference system
G4	logistics, general staff	MI	military intelligence
G5	civil-military operations, general staff	MLRS	multiple launch rocket system
G6	communications, general staff	MMC	materiel management center
GE	Germany	MNF	multinational force
GEN	general	MOPP	mission-oriented protective posture
gp	group	MP	military police
GS	general support	MSB	main support battalion
GSR	general support-reinforcing; ground surveillance radar	msn	mission
		MSR	main supply route
		MTDA	mobilization table of distribution and allowances
HHC	headquarters and headquarters company	mnts	mountains
hist	historian	MTOE	modified table of organization and equipment
HN	host nation	mvr	maneuver
how	howitzer		
HQ	headquarters	NAI	named area of interest
HQ CMDT	headquarters commandant	NATO	North Atlantic Treaty Organization
HQDA	Headquarters, Department of the Army	NBC	nuclear, biological, and chemical
hr	hour	NBCWRS	NBC warning and reporting system
hy	heavy	NCO	noncommissioned officer
		no	number
IAW	in accordance with	NVD	night vision device
ID	identification; identify	obj	objective

off	officer	SJA	staff judge advocate
ops	operations	SOCCE	special operations command and control element
OPCON	operational control	SOCOORD	special operations coordinator
OPLAN	operation plan	SOEO	scheme of engineer operations
OPORD	operation order	SOF	special operations force
OPSEC	operations security	SOI	signal operating instructions
PA	public affairs	SOP	standing operating procedures
pam	pamphlet	SP	self-propelled
PAO	public affairs office/officer	spt	support
para	paragraph	SSO	special security officer
ph	phase	SSORD	service support order
PIR	priority intelligence requirements	SSPLAN	service support plan
PL	phase line	STANAG	standardization agreement
plt	platoon	stmt	statement
PM	provost marshal	STRIKWARN	strike warning
POL	petroleum, oils, and lubricants	SUPPT	supply point
POTF	psychological operations task force	SWO	staff weather officer
pp	pages	T	towed
prep	preparation	tac	tactical
PRF	pulse repetition frequency	TACAIR	tactical air
PSS	personnel service support	TACON	tactical control
PSYOP	psychological operations	TACP	tactical air control party
QSTAG	quadripartite standardization agreement	TAI	target area of interest
R	reinforcing	TALO	theater airlift liaison officer
RAG	regimental artillery group	TCF	tactical combat force
RAOC	rear area operations center	TDA	table of distribution and allowances
recon	reconnaissance	TF	task force
RM	resource management/manager	tgt	target
ROC	rear operations center	tm	team
ROE	rules of engagement	TOC	tactical operations center
ROM	refuel on the move	TOE	table of organization and equipment
ROZ	restricted operations zone	TPL	time-phased line
R&S	reconnaissance and security	TRADOC	US Army Training and Doctrine Command
RTO	radio-telephone operator	trans	transportation
S1	personnel staff officer	UAV	unmanned aerial vehicle
S2	intelligence staff officer	US	United States
S3	operations and training, brigade and battalion staff	USACGSC	United States Army Command and General Staff College
S4	logistics staff officer	USFK	United States Forces Korea
S5	civil-military operations staff officer	vet	veterinarian
S6	communications staff officer	WARNO	warning order
SEAD	suppression of enemy air defense	WCS	weapons control status
SF	Special Forces	WMD	weapons of mass destruction
SGS	secretary of the general staff	wt	weight
sig	signal	ww	world war
SIGSEC	signal security	XO	executive officer

REFERENCES

JOINT PUBLICATIONS

- JP 3-0. *Doctrine for Joint Operations* (In Revision). 1 February 1995.
- JP 3.08. *Interagency Coordination During Joint Operations*, 2 vols. 9 October 1996.
- JP 5-03.-1. *Joint Operation Planning and Execution System Vol I: (Planning Policies and Procedures)*. 4 August 1993.

ARMY PUBLICATIONS

- AR 5-3. *Installation Management and Organization*. 9 October 1992.
- AR 10-5. *Organization and Functions, Headquarters, Department of the Army*. 30 November 1992.
- AR 20-1. *Inspector General Activities and Procedures*. 15 March 1994.
- AR 25-30. *The Army Integrated Publishing and Printing Program*. 28 February 1989.
- AR 25-50. *Preparing and Managing Correspondence*. 21 November 1988.
- AR 27-1. *Legal Services, Judge Advocate Legal Services*. 3 February 1995.
- AR 75-15. *Responsibilities and Procedures for Explosive Ordnance Disposal*. 1 November 1978.
- AR 165-1. *Chaplain Activities in the United States Army*. 31 August 1989.
- AR 310-50. *Authorized Abbreviations, Brevity Codes, and Acronyms*. 15 November 1985.
- AR 360-5. *Army Public Affairs Public Information*. 31 May 1989.
- AR 380-5. *Department of the Army Information Security Program*. 25 February 1988.
- AR 600-20. *Army Command Policy*. 30 March 1988.
- AR 690 Series. *Civilian Personnel*.
- AR 600-8-105. *Military Orders*. 28 October 1994.
- FM 6-20-2. *Tactics, Techniques, and Procedures for Corps Artillery, Division Artillery, and Field Artillery Brigade Headquarters*. 7 January 1993.
- FM 22-100. *Military Leadership*. 31 July 1990.
- FM 25-100. *Training the Force*. 15 November 1988.
- FM 25-101. *Battle Focused Training*. 30 September 1990.
- FM 34-130. *Intelligence Preparation of the Battlefield*. 8 July 1994.
- FM 71-100. *Division Operations*. 28 August 1996.
- FM 100-1. *The Army*. 14 June 1994.
- FM 100-5. *Operations*. 14 June 1993.
- FM 100-6. *Information Operations*. 27 August 1996.
- FM 100-7. *Decisive Force: The Army in Theater Operations*. 31 May 1995.
- FM 100-8. *The Army in Multinational Operations*. 29 January 1991.

FM 101-5

FM 100-11. *Force Integration*. 29 September 1988.

FM 100-15. *Corps Operations*. 29 October 1996.

FM 101-5-1. *Operational Terms and Graphics*. August 1997.

TRADOC Pamphlet 525-70. *Battlefield Visualization Concept*. 1 October 1995.

INDEX

- abbreviations, H-5
- AC². *See* airspace command and control.
- accident risk
 - controls, 5-27
 - definition of, J-1
 - and mission analysis, 5-7
- accountability, of commander, 1-1, 1-2
- ACofS. *See* assistant chief of staff.
- action-reaction-counteraction, 5-22
- AD. *See* air defense.
- ADCOORD. *See* air defense coordinator.
- adjutant general, specific responsibilities of, 4-19
- administrative
 - control, F-2, F-3
 - movement, H-2
 - orders, H-2
 - procedures, staff's, 4-8
 - support, G1 duties, 4-10
- after-action
 - report, and rehearsals, G-9
 - review, K-3
- AG. *See* adjutant general.
- agenda, in rehearsal script, G-7
- aide-de-camp, specific responsibilities of, 4-30
- air defense
 - annex, H-49, H-50
 - considerations for commander's guidance, B-2
 - considerations for mission analysis, A-2
 - coordinator, 4-22, A-2
- air liaison officer, specific responsibilities of, 4-22, 4-23
- air/naval gunfire liaison company commander,
 - specific responsibilities of, 4-23
- airspace command and control, annex, H-63
- ALO. *See* air liaison officer.
- analysis
 - course of action, 5-16
 - course of action, in time-constrained environment, 5-30, 5-31
 - of higher headquarters, 5-5, 5-6
 - of war-game results, 5-22, 5-23, 5-24
- ANGLICO. *See* air/naval gunfire liaison company.
- annex
 - A, H-38
 - B, H-39, H-40
 - C, H-41
 - D, H-42, H-43, H-44
 - described, H-7, H-8
 - E, H-45
 - F, H-46, H-47, H-48
 - format, H-35, H-36, H-37
 - G, H-49, H-50
 - H, H-51, H-52
 - I, H-53, H-54, H-55
 - J, H-56, H-57
 - K, H-58, H-59
 - L, H-60
 - M, H-61
 - N, H-62
 - O, H-63
 - P, H-64, H-65
 - Q, H-66
 - R, H-67, H-68
 - reconnaissance, 5-8
 - S, H-69
 - sequence to OPLAN and OPORD, H-34
 - T, H-70
 - U, H-71
 - V, H-72
- appendix
 - described, H-8
 - format, H-35, H-36, H-37
 - sequence to OPLAN and OPORD, H-34
- approval
 - course of action, 5-25, 5-26, 5-31
 - of restated mission, 5-9
- assets
 - allocating of, and task organization, F-1
 - determining of, 5-7
- assistant chief of staff. *See also* G1; G2; G3; G4; G5; G6.
- assistant commander. *See* deputy commander.
- assumptions
 - and mission analysis, 5-7
 - in operation plans, H-3
 - review of, 5-11
 - and war gaming, 5-17
- attached, command relationship, F-2
- authority
 - of commander, 1-1, 1-2
 - staff officer's, 6-2
- automation management, 4-17
- AVCOORD. *See* aviation coordinator.
- avenue in depth, war-gaming method, 5-18, 5-19

FM 101-5

- aviation coordinator, responsibilities of, 4-23
- backbrief, G-1
- battalion, staff organization, 2-4, 2-5
- battle
 - command training program, K-1
 - drill, G-2
- battlefield
 - understanding of, 1-3
 - visualization, 1-3, C-1, I-1
- belt, war-gaming method, 5-18
- boundary, designation for, H-6
- box, war-gaming method, 5-19
 - in time-constrained environment, 5-30
- brainstorming, and courses of action, 5-12
- branches, 5-31
 - in rehearsals, G-8, G-9
- brevity, in plans and orders, H-4
- briefing, 3-3
 - course of action, 5-16
 - decision, 5-24, 5-25, 5-31
 - information, E-1, E-5, E-6
 - mission analysis, 5-8, 5-9
 - outline, E-3, E-4
 - steps, E-2
 - types of, E-1
 - war-game, 5-24
- brigade, staff organization, 2-4, 2-5
- CCIR. *See* commander's critical information requirements.
- C²W. *See* command and control warfare.
- centralized planning, H-4
- channels, of communications, I-3
- chaplain, specific responsibilities of, 4-30, 4-31
- charts
 - graphic, I-4, I-5
 - narrative, I-4
- chemical officer, specific responsibilities of, 4-23, 4-24
- CHEMO. *See* chemical officer.
- chief of staff
 - and control development, J-2
 - and coordinating staff responsibilities, 4-3
 - and deputy commander, 4-2
 - duties, in operations, 6-1, 6-2
 - in military decision-making process, 5-2
 - personal staff officers under, 4-29
 - as principal staff officer, 2-2
 - rehearsal responsibilities, G-5, G-6, G-9
 - responsibilities of, 4-2, 4-3
 - special staff officers, under coordination of, 4-17, 4-18, 4-19
 - and staff relationship, 4-2
 - war-gaming role, 5-17
- CI. *See* counterintelligence.
- civilian personnel officer, specific responsibilities of, 4-19
- civil-military operations
 - annex, H-71
 - center, 4-15
 - estimate, C-1
 - G5 duties, 4-15
- clarity, in plans and orders, H-4
- classification of plans and orders, H-6
- CMO. *See* civil-military operations.
- COA. *See* course of action.
- color coding, I-4, I-5
- combat
 - orders, H-2
 - power, 5-11, 5-12
 - support, G-8
- combat service support
- considerations for commander's guidance, B-3
 - and rehearsals, G-8
- combined arms rehearsal, G-1
- command
 - channel, I-3
 - and control
 - considerations for commander's guidance, B-3
 - definition of, 1-1
 - system, 1-2
 - definition of, 1-1
 - post, 4-2, K-3
 - relationship, F-1, F-2, F-3
 - temporary, chief of staff, 4-2
- command and control warfare
 - annex, H-64, H-65
- commander
 - center of C² system, 1-1, 1-2
 - initial assessment by, 5-4, 5-5
 - initial guidance by, 5-5
 - and military decision-making process, 5-1
 - rehearsal responsibilities, G-5, G-6, G-9, G-10, G-11
 - relationship with staff, 4-1
 - responsibilities, 4-1
 - role of, in training, K-1
 - in time-constrained environment, 5-28, 5-29
 - use of, control, 1-2
- commander's
 - estimate, C-1, C-2

- guidance, 5-10, B-1, B-2, B-3
 - in time-constrained environment, 5-29
 - commander's critical information requirements
 - characteristics of, I-1
 - and chief of staff, 4-2
 - and DST, H-15
 - and information reporting, 6-4
 - initial, 5-7
 - number of, 6-3
 - commander's intent
 - and control, 1-2
 - definition of, 5-9
 - and mission analysis, 5-9, 5-10
 - placement in OPORD and OPLAN, 5-10
 - command sergeant major, specific duties of, 4-30
 - communications
 - C² system resource, 1-2
 - by staff officers, 3-3
 - written, staff's, 4-7, 4-8
 - communicator, 3-1, 3-3
 - competence, staff officer's, 3-1
 - completeness, in plans and orders, H-6
 - comptroller, specific responsibilities of, 4-18, 4-19
 - concept
 - of operations, 5-26
 - plan, definition of, H-2
 - confidence, 3-1, 3-2
 - confirmation brief, G-1
 - CONPLAN. *See* concept plan.
 - constraints
 - through control measures, 5-14
 - on subordinate commanders, 5-7
 - contingency plan, H-2
 - continuity, in operations, G-5, G-6
 - control, definition of, 1-2
 - controller, in training, K-3
 - controls, J-2, J-3
 - coordinating staff, 2-2, 2-3
 - officers, 4-6, 4-8, 4-9
 - and staff estimates, C-1
 - coordination
 - enclosure to decision paper, D-8
 - of operations, 6-5
 - through plans and orders, H-4
 - of staff actions, 4-6, 4-7
 - of staff study, D-2
 - responsibilities, of special staff officers
 - G1, 4-10
 - G2, 4-11
 - G3, 4-13, 4-14
 - G4, 4-15
 - corps, staff organization, 2-4
 - counterintelligence, G2 duties, 4-11
 - countermobility, considerations for commander's guidance, B-2
 - courier, L-1
 - course of action
 - analysis, and task organization, F-1
 - analysis, in time-constrained environment, 5-30, 5-31
 - analysis, through war gaming, 5-16 through 5-23, 5-24
 - approval, 5-25, 5-26, 5-31
 - briefing, 5-16
 - and commander's estimate, C-2
 - comparison with others, 5-24, 5-31
 - considerations for commander's guidance, B-1
 - criteria, 5-11, 5-14
 - development, reconnaissance in, 5-3
 - development steps, 5-11
 - development, in time-constrained environment, 5-30
 - enemy, 5-6
 - refinement of, 5-26
 - sketch, 5-14, 5-15
 - and staff estimates, C-1
 - statement, 5-14, 5-15
 - CPO. *See* civilian personnel officer.
 - creativity, 3-1, 3-2
 - critical events
 - definition of, 5-17
 - war gaming of, 5-31
 - critical information, I-1, I-2
 - CofS. *See* chief of staff.
 - CS. *See* combat support.
 - CSM. *See* command sergeant major.
 - CSS. *See* combat service support
- dates, unknown, designation of, H-6, H-7
 - decentralized execution, H-4
 - deception
 - annex, H-69
 - considerations for commander's guidance, B-2
 - determining array of forces for, 5-13
 - officer, specific responsibilities of, 4-24
 - decision briefing, E-1
 - commander's, 5-24, 5-25
 - format, E-6
 - in time-constrained environment, 5-31
 - decision making
 - definition of, 5-1

FM 101-5

- decision making
 - and information, I-5, I-6
 - in time-constrained environment, 5-27 through 5-31
- decision-making process, 6-1. *See also* military decision-making process.
- decision matrix, 5-24, 5-25, 5-26
- decision papers, D-6 through D-9
 - definition of, D-6
 - format for, D-6, D-7, D-8
- decision point, 5-10, 5-12
 - cluster, H-9
 - definition of, 5-18
 - and DST, H-9
 - and rehearsal, G-8
- decisions, monitoring execution of, 4-5
- decision support matrix, and rehearsals, G-7, G-8
- decision support template, H-8, H-9, H-10
 - to produce CCIR, I-2
 - and rehearsals, G-7, G-10
- deep operations, annex, H-61
- defensive operation, rehearsal focus, G-1
- delegation of authority, 1-2
 - to coordinating staff, 2-2, 2-3
- dental surgeon, specific responsibilities of, 4-20
- Department of the Army
 - regulation covering staff duties, 4-1
- deployment, and liaison responsibilities, L-4
- deputy commander, and staff relationship, 4-1, 4-2
- direction
 - of actions, 6-4
 - designation of, in plans and orders, H-5, H-6
- director, authority of, 2-3
- division, staff organization of, 2-4
- Drug Enforcement Agency, L-5
- DST. *See* decision support template.

- electronic warfare
 - annex, H-70
 - considerations for commander's guidance, B-2
 - officer, specific responsibilities of, 4-25
- enclosures, D-8, H-8
- ENCOORD. *See* engineer coordinator.
- end state, and rehearsals, G-8
- enemy
 - considerations for commander's guidance, B-1
 - courses of action, 5-6
 - information displayed in command center, I-5
 - information, monitoring of, 6-3
 - portrayal in rehearsals, G-7, G-8

- engineer
 - annex, H-46, H-47, H-48
 - considerations for mission analysis, A-2
 - coordinator, specific responsibilities of, 4-25
- environment
 - IPB to determine, 5-6
 - time-constrained, and decision making, 5-27 through 5-31
- EOA. *See* equal opportunity advisor.
- equal opportunity advisor, specific responsibilities of, 4-20
- equipment, C² system resource, 1-2
- essential
 - elements of friendly information, 5-8, I-2
 - tasks, 5-7, 5-10
- estimate
 - commander's, C-1, C-2
 - and determination of task organization, F-1
 - format, C-3
 - and military decision-making process, 5-3
 - staff responsibility, 4-4
 - types of, C-1, C-2, C-3
- evaluation
 - of controls, J-3
 - criteria, determining of, 5-18
 - criteria, in time-constrained environment, 5-31
- event template, 5-6
- EWO. *See* electronic warfare officer.
- exceptional information, I-2
- execution
 - information, 1-3
 - matrix, H-8, H-10
- executive officer. *See* chief of staff.
 - duties of, in operations, 6-1, 6-2
 - location of, 4-2
- explosive ordnance disposal officer, specific responsibilities of, 4-25, 4-26
- exposure, J-2

- facilities, C² system resource, 1-2
- facts
 - and mission analysis, 5-7
 - in plans and orders, H-3
 - review of, 5-11
- Federal Emergency Management Agency, L-5
- feedback, G-9
- fields of interest, 2-1, 2-3
- finance officer, specific responsibilities of, 4-20
- fire support
 - annex, H-42, H-43, H-44
 - considerations for commander's guidance, B-1, B-2

- fire support coordinator, 2-3
 - and mission analysis considerations, A-1, A-2
 - specific responsibilities of, 4-26
- flexibility
 - through plans and orders, H-4
 - staff officer's, 3-1, 3-2
- force
 - array of, determining, 5-12, 5-13
 - development, G3 duties, 4-13
 - modernization, G3 duties, 4-13
 - ratio, 5-11, 5-12
- format
 - annex, H-35, H-36, H-37
 - annotated, for OPLAN and OPORD, H-14 through H-19
 - appendix, H-35, H-36, H-37
 - fragmentary order, H-29
 - movement order, H-25, H-26
 - for OPLAN and OPORD, H-12, H-13
 - overlay order, H-30, H-31
 - service support order, H-20 through H-24
 - staff estimate, generic, C-3
 - warning order, H-27, H-28
- fragmentary order
 - definition of, H-3
 - format, H-29
 - and rehearsals, G-6, G-8, G-11
- FRAGO. *See* fragmentary order.
- fratricide, H-4
- friendly
 - deployment in rehearsals, G-7, G-8
 - force, war-gaming list, 5-17
 - forces information requirements, 5-8, I-2
- FSCOORD. *See* fire support coordinator.
- full dress rehearsal, G-2

- G1
 - mission analysis considerations, A-1, A-2
 - and personnel estimate, C-2
 - role in war gaming, 5-17
 - and special staff officers, 4-19, 4-20, 4-21, 4-22
 - specific responsibilities of, 4-9, 4-10
- G2
 - and intelligence estimate, C-2
 - and mission analysis considerations, A-1
 - rehearsal responsibilities, G-6, G-10, G-11
 - role in war gaming, 5-17
 - and special staff officer, 4-21, 4-22
 - specific responsibilities of, 4-10, 4-11
- G3
 - and intelligence estimate, G-2
 - and mission analysis considerations, A-1
 - and operations estimate, C-2
 - rehearsal responsibilities, G-6, G-9
 - role in war gaming, 5-17
 - and special staff officers, 4-21 through 4-28, 4-29
 - specific responsibilities of, 4-12, 4-13, 4-14
- G4
 - and logistics estimate, C-2
 - and mission analysis considerations, A-1
 - and movement order, H-2
 - role in war gaming, 5-17
 - and service support order, 4-29
 - and special staff officer, 4-29
 - specific responsibilities of, 4-14, 4-15
- G5
 - and civil-military operations estimate, C-2
 - and mission analysis considerations, A-1
 - specific responsibilities of, 4-14, 4-16
- G6
 - and mission analysis considerations, A-1
 - and signal estimate, C-2
 - specific responsibilities of, 4-16, 4-17
 - graphics
 - control measures, 5-13, 5-14
 - display, I-3, I-4, I-5
 - use of, in plans and orders, H-5
- G staff officers, 2-3, 2-4
- gumball chart, I-4, I-5

- hasty war game, 5-30
- hazard, J-1, J-2
- headquarters
 - assigning of, 5-14
 - management, by G1, 4-10
- headquarters commandant
 - and chief of staff, 4-3
 - specific responsibilities of, 4-18
- health support, 4-9
- historian, specific responsibilities of, 4-26, 4-27
- host nation, considerations for mission analysis, A-1

- identification, heading for plans and orders, H-7
- IG. *See* inspector general.
- implied tasks, 5-7

FM 101-5

informal memorandum. *See* decision paper.

information

- assumptions, 5-7
- briefing, E-1, E-5
- considerations for commander's guidance, B-2
- and coordinating staff, 2-3
- critical, I-1, I-2
- enemy, monitoring of, 6-3
- exceptional, I-2
- facts, 5-7
- friendly, monitoring of, 6-3, 6-4
- graphics display, I-4, I-5
- management of, 6-4, 6-5, I-1 through I-6
- means for dissemination, 6-4, 6-5
- presentation of, I-3, I-4, I-5
- providing of, to commander, 4-3, 4-4
- reporting system, I-4
- reports by exception, I-4
- routine, I-2
- security, G6 duties, 4-17
- staff's handling of, 4-5, 4-6
- staff provides to commander, I-3
- steps for managing, 6-4
- to support battlefield visualization, 1-3

initial

- assessment, 5-4
- guidance, 5-5

initiative, 3-1

inspections, staff's conduct of, 4-7

inspector general, specific responsibilities of, 4-31

installation staff, regulation covering, 4-1

integration, of staff activities, 4-3, 4-7

intelligence

- annex, H-39, H-40
- considerations for commander's guidance, B-1
- estimate, C-1
- training, and G2,

intelligence preparation of the battlefield

- considerations for mission analysis, A-1
- during mission analysis, 5-6
- training in, K-3

interagency operations, L-5, L-6

IPB. *See* intelligence preparation of the battlefield.

joint operations, and liaison responsibilities, L-4, L-5

joint readiness training center, K-1

judgment, 3-1

key tasks, 5-9

laws, and staff organization, 2-1

liaison

- checklist, L-6
- definition of, L-1
- detachments, L-1
- duties after tour, L-4
- duties during tour, L-3, L-4
- handling of, by chief of staff, 4-2
- nonreciprocal, L-2
- officer, L-1, L-2
 - and chief of staff, 4-3
 - and information management, I-4
 - specific responsibilities of, 4-27
- receiving unit responsibilities, L-3
- sending unit responsibilities, L-2, L-3
- teams, L-1, L-4, L-5

liaison officer's handbook, L-7, L-8, L-9

LNO. *See* liaison officer.

location, designation of, H-5, H-6

logistics

- considerations for mission analysis, A-1
- estimate, C-1
- operations, G4 duties, 4-14

loyalty, 3-1, 3-2

main effort

- and array of forces, 5-13
- and COA development, 5-12
- considerations for commander's guidance, B-1

maintenance, G4 duties, 4-14

manager, staff officer as, 3-1, 3-3

maneuver, considerations for commander's guidance, B-1

manning, G1 duties, 4-9

map rehearsal, G-4

materiel officer, specific responsibilities of, 4-17

matrix, H-8, H-9, H-10

- method of task organization, F-5, F-6

MDMP. *See* military decision-making process.

memorandum for record, E-3

METL. *See* mission-essential task list.

METT-T

- and battlefield visualization, I1
- and control, I-2

military decision-making process

- advantage of using when abbreviated, 5-28
- described, 5-1
- full, advantage of using, 5-1
- full, disadvantage of using, 5-1
- training in, K-1, K-2

- MI. *See* military intelligence.
- military intelligence, G2 duties, 4-10
- mission
- accomplishment
 - through battlefield visualization, 1-3
 - through control, 1-2
 - analysis, 5-5, A-1, A-2
 - analysis, in time-constrained environment, 5-29
 - briefing, E-1, E-6, E-7
 - oriented protective posture, and war gaming, 5-23
 - receipt of, 5-3, 5-4, 5-5
 - receipt of, in time-constrained environment, 5-29
 - repeated, 5-8
 - and staff organization, 2-1
 - statement, H-4
- mission-essential task list, K-1
- mobility, considerations for commander's guidance, B-2
- modified table of organization and equipment, 2-2
- MOPP. *See* mission-oriented protective posture.
- movement order
- definition of, H-2
 - format, H-25, H-26
- multiechelon
- considerations in rehearsals, G-2, G-3, G-4, G-5
 - exercises, and training, K-1
 - operations, and liaison considerations, L-5
- named areas of interest, H-9
- naming convention, H-6
- narrative chart, I-4
- NBC. *See* nuclear, biological, chemical
- NCO. *See* noncommissioned officer.
- noncommissioned officer, role in MDMP, K-2.
See also command sergeant major.
- nonconcurrence, enclosure to decision paper, D-9
- nongovernment organization, L-6
- nuclear, biological, chemical
- annex, H-56, H-57
 - considerations for commander's guidance, B-2
 - considerations for mission analysis, A-2
 - and war gaming, 5-23
- observer, in training, K-3
- offensive operations, in rehearsal, G-1
- OPCON. *See* operational control.
- operational control, F-2
- operation order
- characteristics of, H-3, H-4
 - definition of, H-2
 - format, annotated, H-14 through H-19
 - format outline, H-12, H-13
 - and rehearsal, G-7
 - WWII, H-74 through H-79
- operation overlay, H-4
- annex, H-41
- operation plan
- characteristics of, H-3, H-4
 - definition of, H-2
 - format, annotated, H-14 through H-19
 - format outline, H-12, H-13
- operations
- estimate, C-1, C-2
 - execution of, 6-1
 - G3 duties in, 4-12, 4-13
 - monitoring of, 6-3
 - preparation for, 6-1
 - synchronization of, 6-5
- operations security
- annex, H-66
 - considerations for commander's guidance, B-2
 - considerations in rehearsals, G-2, G-3, G-4, G-5
 - G3 duties, 4-13
- OPLAN. *See* operation plan.
- OPORD. *See* operation order.
- OPSEC. *See* operations security.
- orders, H-2, H-3
- administrative instructions, H-5 through H-7, H-8
 - approval of, 5-27
 - characteristics of, H-1
 - definition of, H-2
 - distributing of, by G3, 4-12
 - oral, H-3, H-5
 - preparing of, by staff, 4-5
 - production of, after COA selection, 5-26, 5-27
 - purpose of, H-1
 - use of, in training, K-3
- orientation, rehearsal, G-9
- outline, method of task organization, F-3, F-4
- overlay order, H-4, H-5
- format, H-30 through H-33
- PA. *See* public affairs.
- page numbering, of plans and orders, H-7
- PAO. *See* public affairs officer.
- parallel planning, 5-5, 5-8
- with higher headquarters, 5-29
 - and IPB, 5-6
 - use in time-constrained environment, 5-28, 5-29

FM 101-5

- peacetime operations, liaison considerations, L-5
- personal staff, 2-3, 4-29 through 4-32
 - officer, 4-8, 4-10
- personnel
 - C² system resource, 1-2
 - estimate, C-1, C-2
- personnel service support, G1 duties, 4-10
- phase line, designation of, H-7
- pictorial chart, I-4
- PIR. *See* priority intelligence requirements.
- planning. *See* parallel planning.
- plans, H-1, H-2
 - administrative instructions, H-5 through H-7, H-8
 - characteristics of, H-1
 - concept, H-2
 - contingency, H-2
 - definition of, H-1
 - G3 duties, 4-12, 4-13
 - preparing of, by staff, 4-5
 - purpose of, H-1
 - use of, in training, K-3
- PM. *See* provost marshal.
- priority intelligence requirements, 5-8, I-2
- private voluntary organization, L-6
- problem, identifying and analyzing, by staff, 4-6
- procedures, C² system resource, I-2
- provost marshal
 - annex, H-58, H-59
 - specific responsibilities of, 4-27
- psychological operations
 - annex, H-67, H-68
 - considerations for commander's guidance, B-2
 - officer, specific responsibilities of, 4-28
- PSYOP. *See* psychological operations.
- public affairs
 - annex, H-72
 - considerations for commander's guidance, B-2
 - officer, specific responsibilities of, 4-31, 4-32
- push system, in information reporting, 5-4

- radio rehearsal, G-4, G-5
- rear operations, annex, H-62
- reciprocal liaison, L-2
- recommendations, making of, 4-4, 6-5
- reconnaissance
 - annex, initial, 5-8
 - in planning process, 5-2, 5-3
 - and surveillance annex, H-60
- recorder
 - rehearsal responsibilities, G-6, G-10, G-11
 - use of, in war gaming, 5-31
- reduced force rehearsal, G-2, G-3
- references, in OPLAN and OPORD, H-14
- regiment, staff organization, 2-4, 2-5
- regulations, and staff organization, 2-1
- rehearsal
 - conduct of, G-8 through G-11
 - definition of, G-1
 - higher headquarters responsibilities, G-5
 - leader, G-9
 - script, G-6, G-7, G-8
 - sequence of events, G-7, G-8
 - site, G-5
 - techniques, G-2 through G-4, G-5
 - types of, G-1, G-2
- reports, 4-5
- research, staff, 4-8
- residual risk, J-2
- resource manager, specific responsibilities of, 4-18, 4-19
- resources, effective management of, 3-3
- response sequence, in rehearsal script, G-7
- responsibilities
 - of commander, 1-1, 1-2
 - staff, common, 4-3 through 4-7, 4-8
 - staff, specific, 4-8
- restated mission, 5-8
- risk, J-2
 - acceptable, 5-26
 - assessment, J-2
 - and mission analysis, 5-7
 - in staff estimates, C-2
 - decision, J-1, J-3
 - minimizing through information, I-6
 - in reconnaissance, 5-3
- risk management, 6-2, J-1, J-2, J-3
 - and chief of staff, 4-3
 - in COA development, 5-11
 - integration of, 4-3
 - staff's role in, 4-7
 - during war gaming, 5-22, 5-23, 5-24
- RM. *See* resource manager.
- routine information, I-2

- S1. *See* G1.
- S2. *See* G2.
- S3. *See* G3.

- S4. *See* G4.
- S5. *See* G5.
- S6. *See* G6.
- safety officer, specific responsibilities of, 4-28
- scheme of maneuver, 5-13, 5-14
- script, to control rehearsal, G-6, G-7, G-8
- secretary of the general staff
 - and chief of staff, 4-3
 - specific responsibilities of, 4-18
- security operations, G2 duties performed, 4-11
- sequel, 5-31
- services, G4 duties performed, 4-15
- service support annex, H-53 through H-55
- service support order
 - definition of, H-2
 - format, H-20 through H-24
- service support plan, definition of, H-2
- severity, J-2
- SGS. *See* secretary of the general staff.
- signal
 - annex, H-51, H-52
 - estimate, C-1
 - operations, G6 duties, 4-16, 4-17
- SIGSEC. *See* signals security.
- simplicity, H-4
- sister services, and training, K-3
- SITTEMP. *See* situation template.
- situational awareness, 1-3
- situation template, 5-6, H-8
- SJA. *See* staff judge advocate.
- sketch
 - map rehearsal, G-4
 - note, to record war-game results, 5-19
- small group instruction, K-3
- SOCOORD. *See* special operations coordinator.
- SOP. *See* standing operating procedures.
- special operations coordinator, specific responsibilities of, 4-28, 4-29
- special security office, 4-11
- special staff, 2-3
 - estimates, C-1
- special staff officers, 4-8, 4-17
 - and G1, 4-10
 - and G3, 4-13, 4-14
 - and G4, 4-15
 - role in war gaming, 5-17
- specified tasks, 5-6
- SSORD. *See* service support order.
- staff
 - and administrative procedures, 4-8
 - aiding commander in control, 1-2
 - assistance visits, 4-7
 - authority delegated to, 1-2
 - basic structure, 2-2, 2-3, 2-4
 - and battlefield visualization, 1-3
 - briefing, E-1, E-2, E-7
 - channel, I-3
 - and commander relationship, 4-1
 - and command training, 4-7
 - common responsibilities of, 4-3 through 4-7, 4-8
 - conduct of inspections, 4-7
 - and conduct of research, 4-8
 - coordination, 4-6, 4-7
 - and deputy commander relationship, 4-1, 4-2
 - estimates, C-1, C-2, C-3
 - and handling of information, 4-5, 4-6
 - papers, assembling of, D-10
 - organization of, 2-1 through 2-5
 - rehearsal responsibilities, G-6
 - and risk management, 4-7
 - role of, in C², 1-3
 - role of, in military decision-making process, 5-1, 5-2
 - role in time-constrained environment, 5-29
 - and supervision of personnel, 4-8
 - training of, 1-3
 - and written communications, 4-7, 4-8
- staff judge advocate, specific responsibilities of, 4-32
- S staff officers, 2-4
- staff officer
 - duties of, in preparing and executing operations, 6-2 through 6-6
 - considerations in mission analysis, A-1, A-2
 - role in MDMP, K-2
- staff organization
 - authorization for, 2-1
 - battalion, 2-4, 2-5
 - brigade, 2-4, 2-5
 - corps, 2-4
 - division, 2-4
 - factors affecting, 2-1
 - regiment, 2-4, 2-5
 - planning,
 - by G1, 4-10
 - by G2, 4-11
 - by G3, 4-11
 - by G4, 4-15

FM 101-5

- planning
 - by G5, 4-16
 - G6 duties, 4-17
- staff study, D-1 through D-6
 - coordination of, D-2
 - format for, D-3, D-4, D-5
 - preparation steps, D-1, D-2
 - problems in, D-2
- staff weather officer, specific responsibilities of, 4-11
- standing operating procedures, H-8
 - and continuity, 6-6
 - for disseminating information, 6-5
 - for managing information, 6-4
 - and planning process, 5-3, 5-4
 - and rehearsals, G-1
 - rehearsal, G-2
 - and training, K-3
- subordinate leaders, rehearsal responsibilities, G-5, G-6, G-11
- summaries, to disseminate information, 4-5
- supervision, staff, of personnel, 4-8
- supply, G4 duties, 4-14
- support
 - rehearsal, G-1, G-2
 - effort, and array of forces, 5-13
- supporting effort
 - and COA development, 5-12
 - considerations for commander's guidance, B-1
- supporting plan, definition of, H-2
- support operations officer, specific responsibilities of, 4-17
- support relationship, F-1, F-2, F-3
- surgeon, specific responsibilities of, 4-21. *See also* dental surgeon.
- survivability, considerations for commander's guidance, B-2
- SWO. *See* staff weather officer.
- synchronization
 - and information, I-5
 - through rehearsal, G-6, G-9
- synchronization matrix, G-7, G-10
 - described, H-9, H-10
 - to record war-game results, 5-19, 5-20, 5-21
- table of distribution and allowances, 2-2
- table of organization and equipment, 2-2
- tabs, H-8
- tactical control, F-2
- tactical risk
 - definition of, J-1
 - and mission analysis, 5-7
- TALO. *See* theater airlift liaison officer.
- target areas of interest, H-9
- task organization
 - annex, H-38
 - matrix method, F-5, F-6
 - in OPLAN and OPORD, H-14
 - outline method, F-3, F-4
 - sequence of, F-6, F-7
- tasks, 5-6, 5-7
 - key, 5-9
- team player, staff officer as, 3-1, 3-2, 3-3
- technical channel, I-3
- templates, H-8, H-9, H-10. *See also* decision support template; situation template.
- terrain
 - model rehearsal, G-3, G-4
 - rehearsal considerations, G-2, G-3, G-4
- theater airlift liaison officer, specific responsibilities of, 4-29
- time
 - allocation of, in planning, 5-4, 5-5
 - annotating of, on plans and orders, H-7
 - considerations, in rehearsal, G-1, G-2, G-3, G-4, G-5
 - management of, 3-3, 6-2, 6-3
 - planning use of, 5-8
 - saving of, in time-constrained environment, 5-27, 5-28
- time-constrained environment, 5-27 through 5-31
 - and oral orders, H-5
- time line
 - MDMP, G-2
 - staff, and chief of staff, 4-2
- timeliness, in plans and orders issuance, H-4
- time-phased lines, and DST, H-9, H-10
 - unknown, designation of, H-6, H-7
- time zone, in OPLAN and OPORD, H-14
- TO. *See* transportation officer.
- training, K-1, K-2, K-3
 - G3 duties, 4-12
 - intelligence, 4-11
 - in IPB process, K-3
 - on military decision-making process, 5-27
 - of staff, 4-1
 - staff, by commander, 1-3
 - staff, and chief of staff, 4-2
 - command, staff responsibility, 4-7
 - transportation
 - G4 duties, 4-15
 - officer, specific responsibilities of, 4-29
- update, of estimates, C-1

- United States Forest Service, L-5
- veterinary officer, specific responsibilities of, 4-21
- vignette, WWII operation order, H-75 through H-79
- warfighting plans, 4-2
- war-game
 - briefing, 5-24
 - and task organization, F-1
 - work sheet, 5-19, 5-22
- war gaming
 - to analyze COAs, 5-16 through 5-23, 5-24
 - methods of, 5-18, 5-19
 - to produce CCIR, I-2
 - recording of results, 5-19, 5-20, 5-21, 5-22
 - results of, 5-23, 5-24
 - rules of, 5-16
 - steps of, 5-17 through 5-23, 5-24
 - tools for, 5-17
 - in time-constrained environment, 5-30, 5-31
- warning order
 - after COA approval, 5-26
 - after commander's guidance, 5-10, 5-11, 5-30
 - definition of, H-3
 - format, H-27, H-28
 - in mission receipt phase, 5-5
 - on receipt of mission, 5-3
 - use in time-constrained environment, 5-28, 5-29
- WARNO. *See* warning order.
- weapons of mass destruction, 5-23
- XO. *See* executive officer.

FM 101-5
31 MAY 1997

By Order of the Secretary of the Army:

Official:



Handwritten signature of Joel B. Hudson in cursive script.

JOEL B. HUDSON
*Administrative Assistant to the
Secretary of the Army*
03762

DENNIS J. REIMER
*General, United States Army
Chief of Staff*

DISTRIBUTION:

Active Army, Army National Guard, and U.S. Army Reserve: To be distributed in accordance with the initial distribution number 110412, requirements for FM 101-5.

